

TITANIC

LIBRO 1

→ Postal de la naviera
White Star Line con una
ilustración del Titanic.

EL REY DE LOS OCÉANOS

Cuando el RMS *Titanic* zarpó del puerto de Southampton (Inglaterra) el 10 de abril de 1912 en su viaje inaugural con destino a la ciudad de Nueva York, no solo era el barco más grande del mundo y de la época, sino también el más lujoso. Emprendía la navegación como segundo de un trío de innovadores buques de la clase Olympic encargados por la naviera White Star Line en su esfuerzo por mantener la supremacía en la competitiva ruta transatlántica de transporte de pasajeros. La compañía había autorizado a la constructora naval Harland and Wolff de Belfast a gastar todo lo que fuera necesario para garantizar que el *Titanic* contara con un nivel de confort y lujo nunca vistos.





↑ Buque RMS Titanic partiendo de Southampton el 10 de abril de 1912.

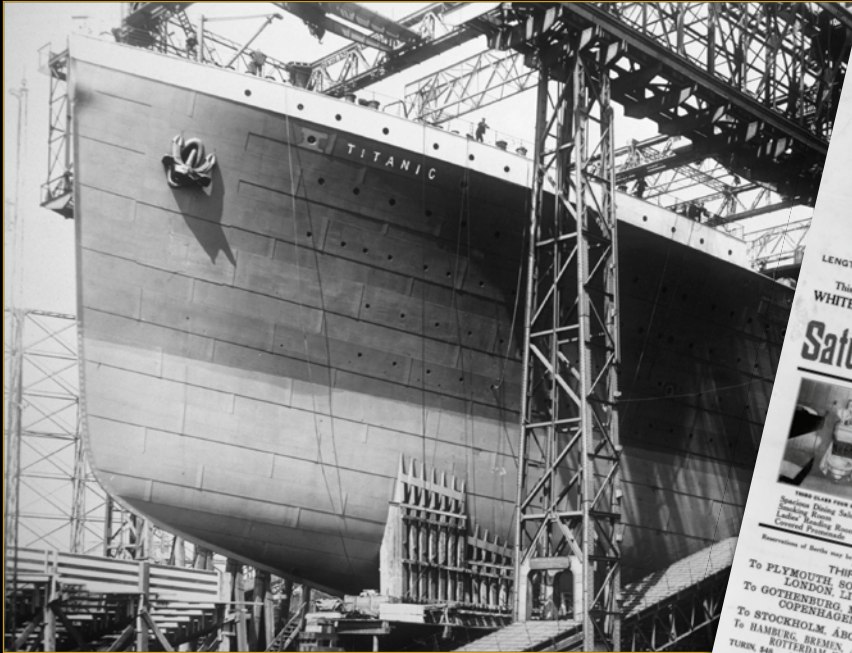

↑ Proa del Titanic durante su construcción en los astilleros Harland and Wolff de Belfast (Irlanda).

WHITE STAR LINE
 ROYAL & UNITED STATES MAIL STEAMERS
 FIRST SAILING OF THE LATEST ADDITION TO THE WHITE STAR FLEET
 The Queen of the Ocean
TITANIC

LENGTH 682 FT. OVER 45,000 TONS TRIPLE-SCREWS BEAM 92 FT.
 This, the Latest, Largest and Finest Steamer Afloat, will sail from
WHITE STAR LINE, PIER 59 (North River), NEW YORK

Saturday, April 20th At 12 Noon

THIRD CLASS CABIN DECK FOUR
 Spacious, Clean, Well-lit
 Ladies' Smoking Room
 General Promenade

All passengers booked in closed rooms
 but equipped with washstands, etc.

THIRD CLASS RATES ARE:
 To PLYMOUTH SOUTHAMPTON
 LONDON LIVERPOOL and GLASGOW.
 To GOTHENBURG MALMÖ CHRISTIANIA,
 COPENHAGEN, ESBJERG, Etc.
 To STOCKHOLM, ÅBO, HANGÖ, HELSINGFORS,
 HAMBURG, BREMEN, ANTWERP, AMSTERDAM,
 ROTTERDAM, HAVRE, CHERBOURG,
 NAPLES, BRINDISI, PIRAEUS, ETC.
 DO NOT DELAY. Passage paid alike through the White Star Line or direct from
 WHITE STAR LINE, 9 Broadway, New York

TICKETS FOR SALE HERE

THIRD CLASS RATES ARE:
 \$36.25
 41.50
 44.50
 45.00

← 1912: Cartel publicitario del transatlántico de lujo Titanic anunciando la fecha de partida del buque en su viaje inaugural. Incluye los precios de los pasajes y la descripción de los camarotes.



→ Dos barcos de la naviera White Star Line, el RMS Titanic y el RMS Olympic, la última vez que pudieron verse juntos: el 3 de febrero de 1912.

EL BUQUE DE LA CLASE OLYMPIC DE TRIPLE HÉLICE

El *Titanic* avanzaba propulsado por tres potentes motores, y cada uno de ellos movía su propia hélice. Los dos motores de vapor exteriores medían 19 m de longitud, pesaban 720 t y generaban una potencia total de más de 30.000 CV. La turbina de baja presión central agregaba unos 16.000 CV adicionales. Para mantener en funcionamiento los motores de vapor, se usaban 29 calderas y se consumían 484,5 t de agua y 600 t de carbón diarias. Los tres motores estaban conectados directamente a sus respectivas hélices mediante largos ejes. Las dos gigantescas hélices laterales medían 7,2 m de diámetro, mientras que la del medio, más pequeña, tenía un diámetro de 5,2 m. Toda esta potencia permitía al *Titanic* alcanzar una velocidad máxima de 23 kn (cerca de 43 km/h).

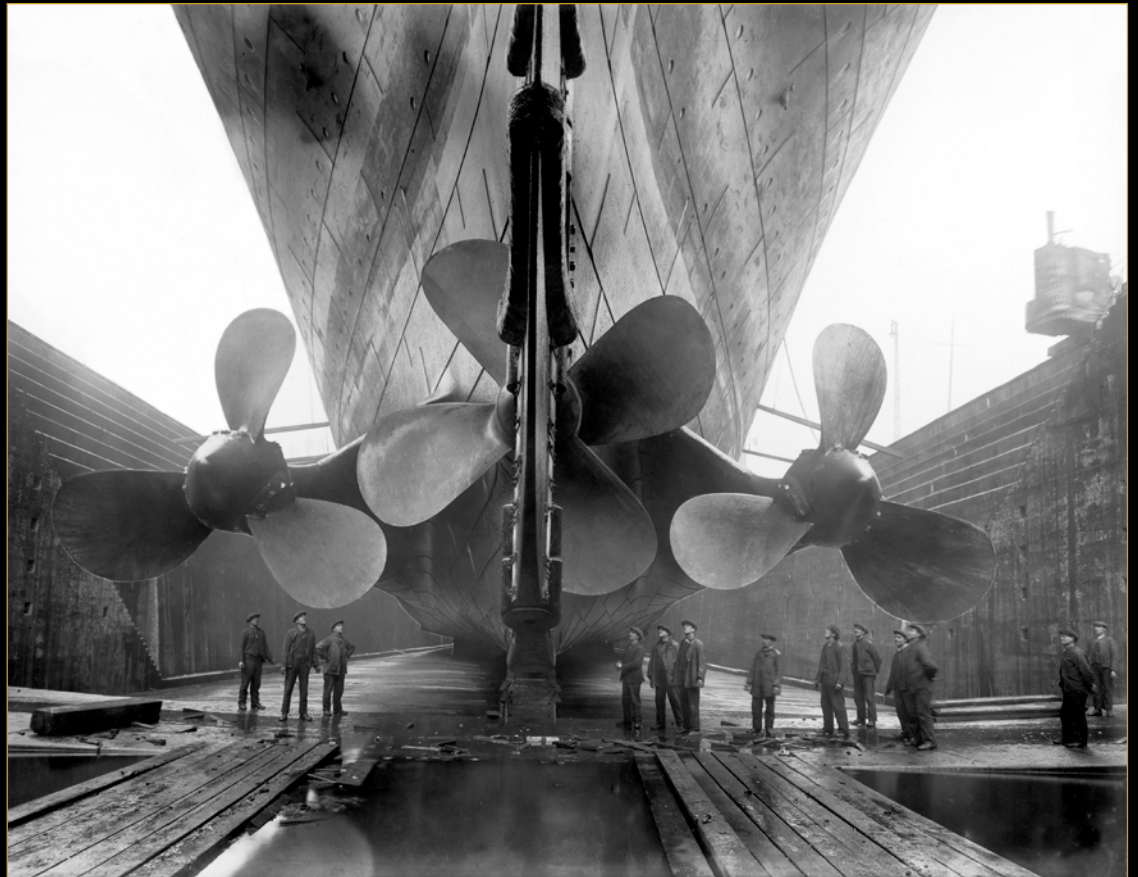

↑ Vista de las inmensas hélices del RMS Titanic con el imponente buque en dique seco.



LEGO.com/brickseparator

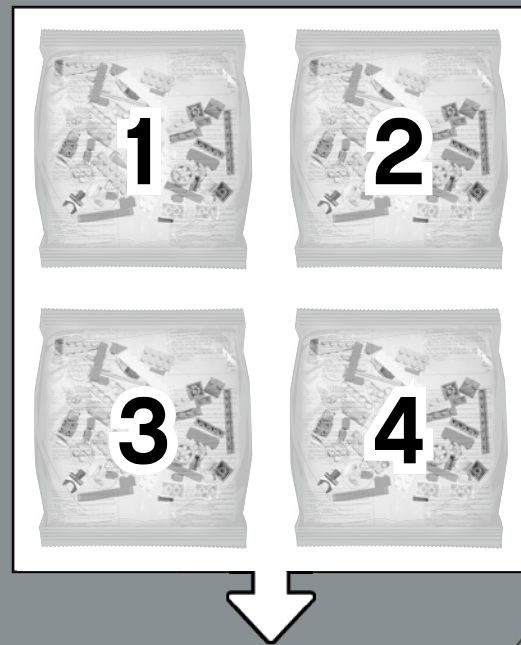

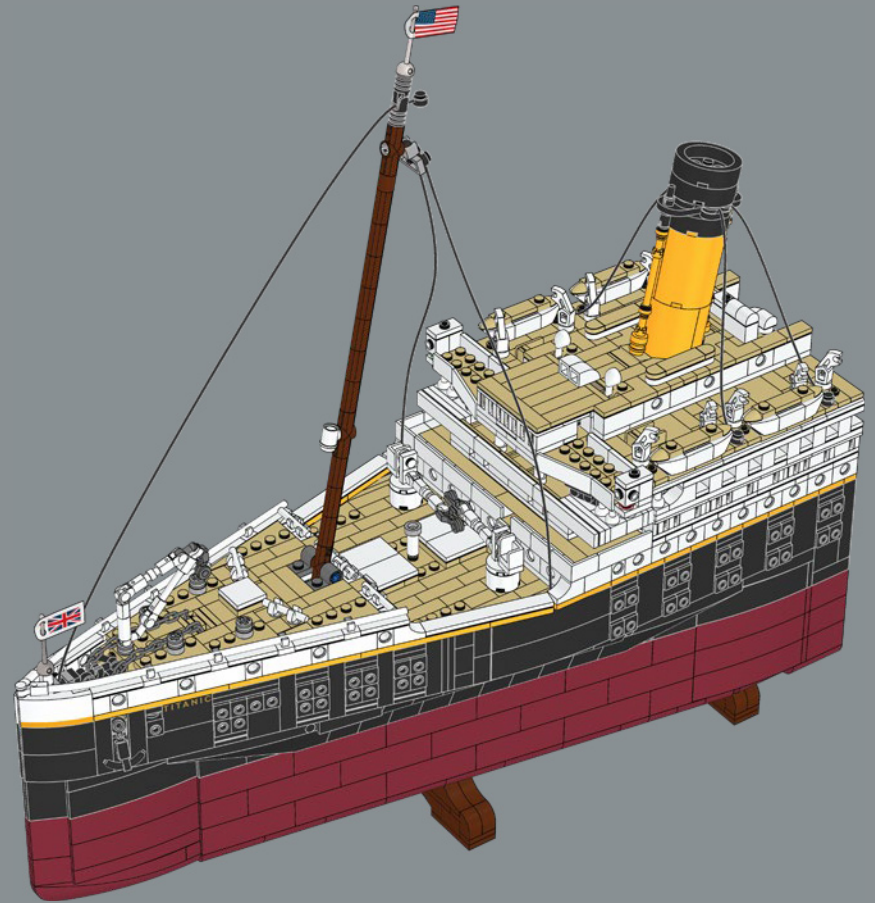
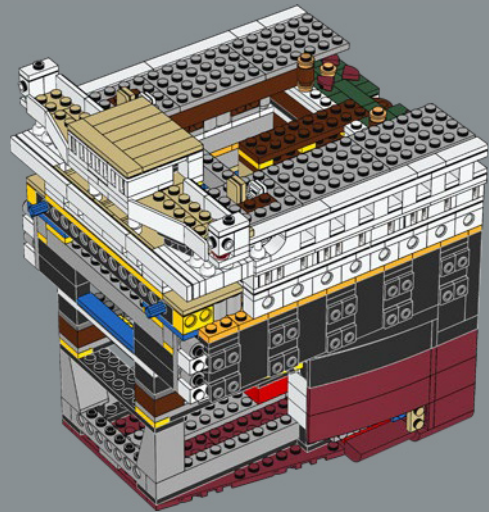
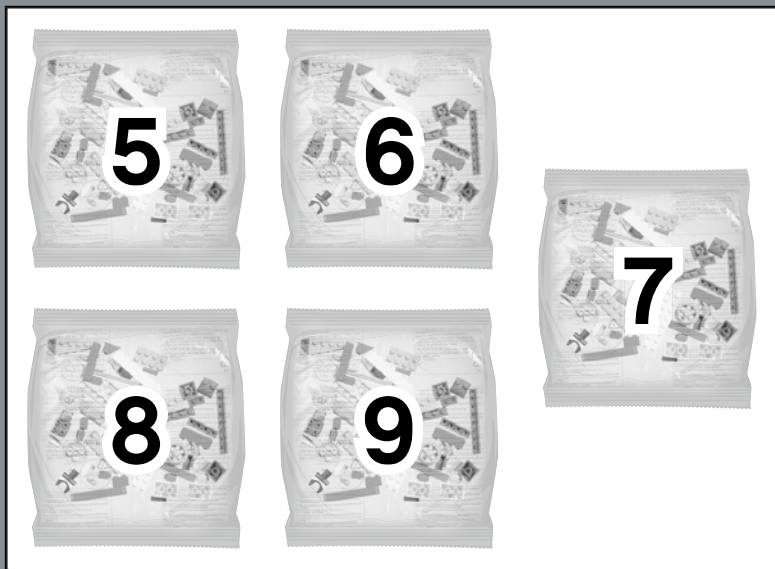

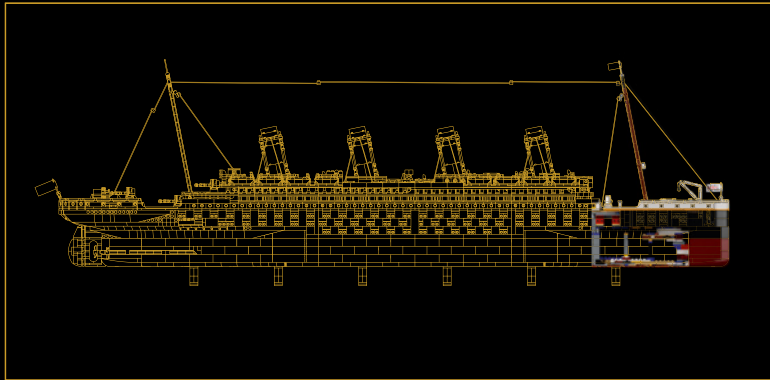

SECCIÓN 1:

PROA Y CUBIERTA DE POZO

En esta sección, construirás la proa del buque, así como las anclas, el rótulo con el nombre, la cubierta de pozo, las escotillas de carga y las grúas de carga, la grúa de anclas con la tercera ancla, y el trinquete. También te encargarás de la construcción en el interior de las estructuras de soporte del casco de proa con forma de cuña. Estas se combinarán con soportes en secciones posteriores para acoplar y rematar el casco frontal del modelo.

↓ Usamos el arco de triple borde curvado 2x10x2 para formar la parte frontal de la quilla del modelo.



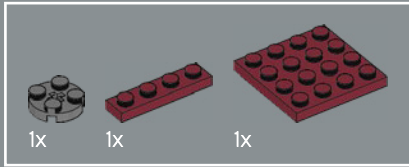
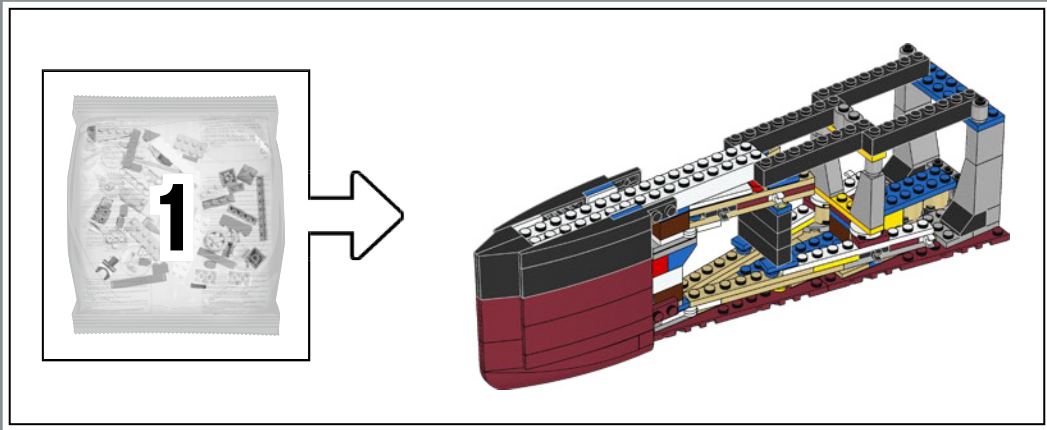

2

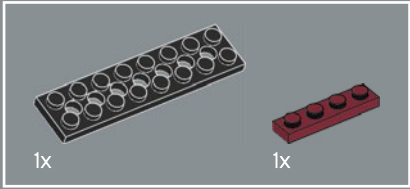

1

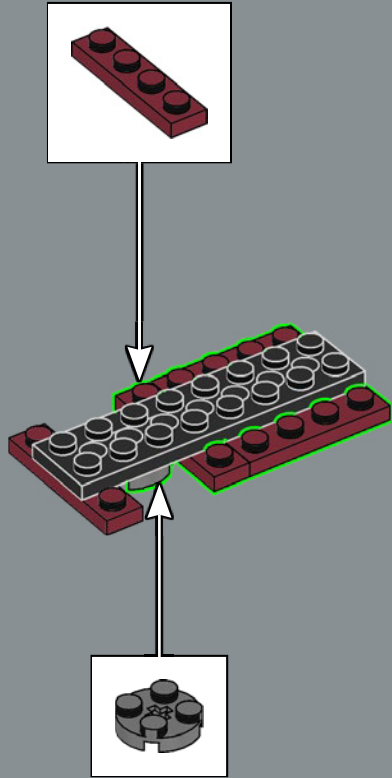
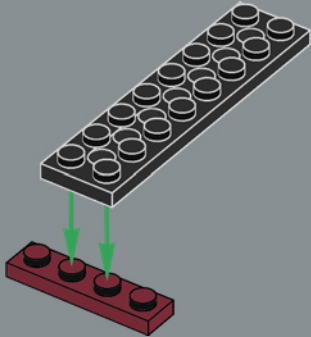

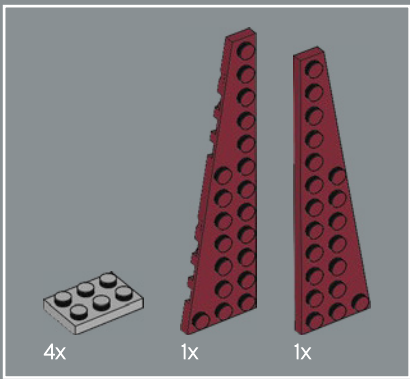

3

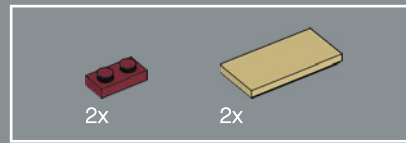
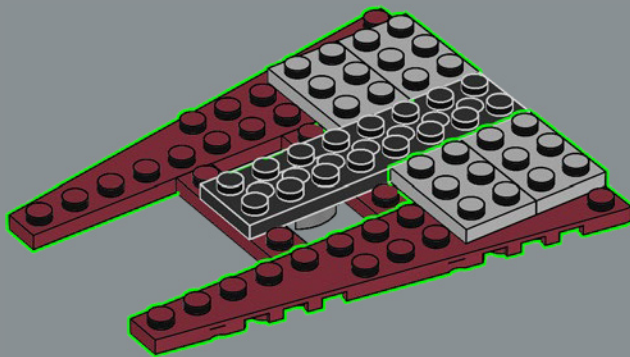

4

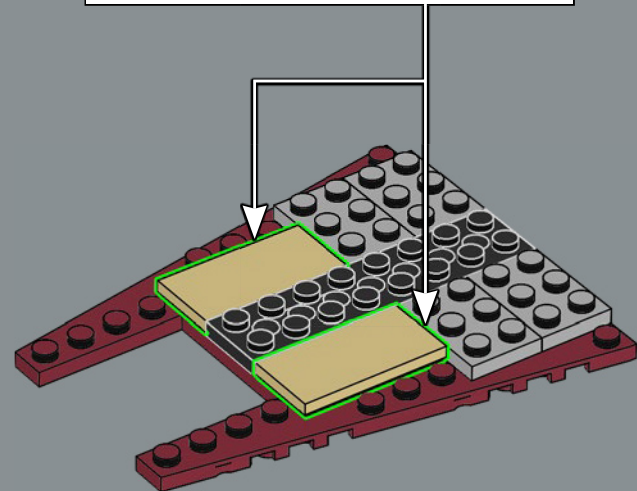
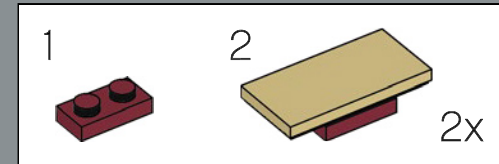

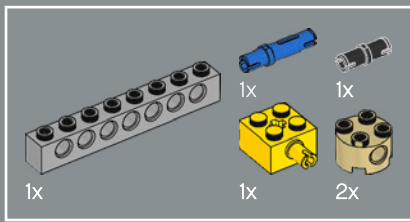

5

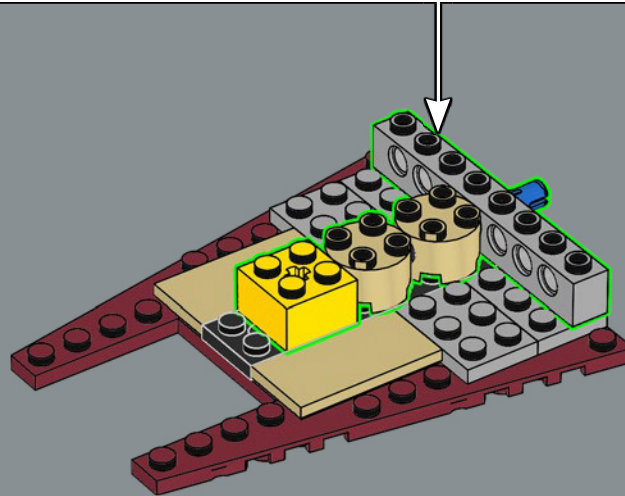
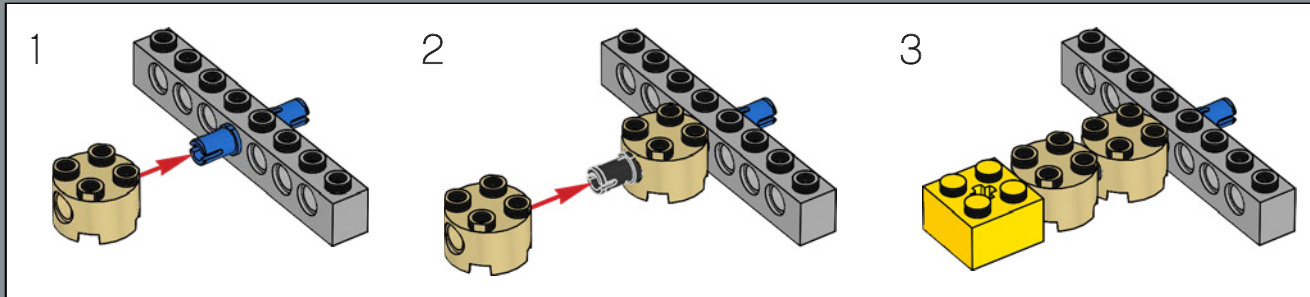

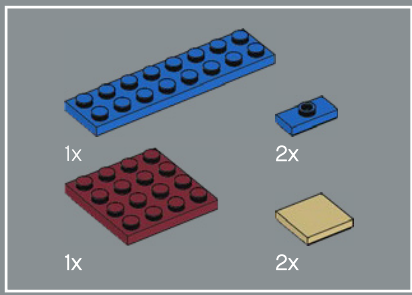

6

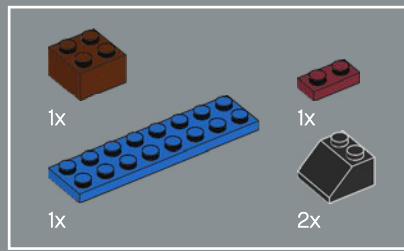
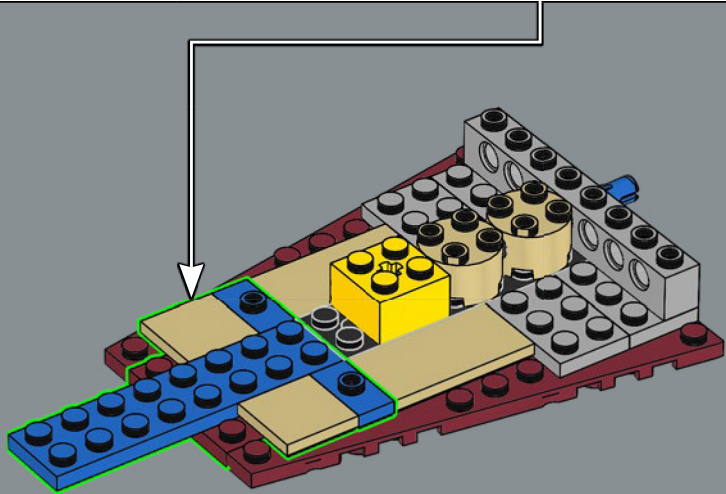
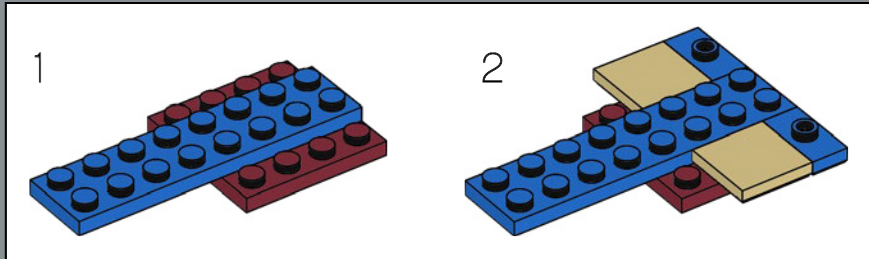

7

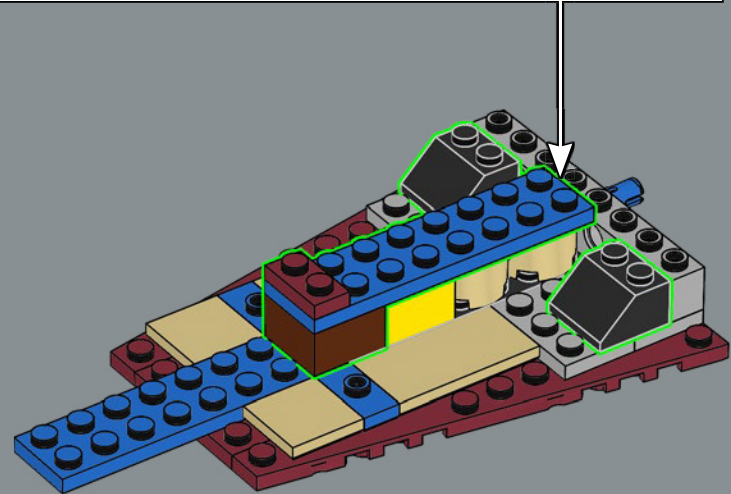
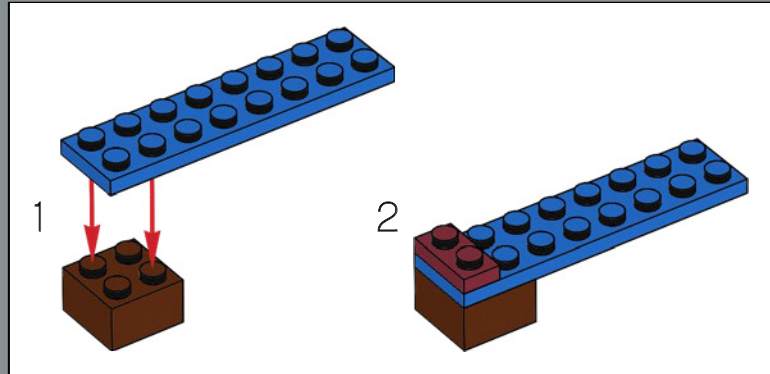

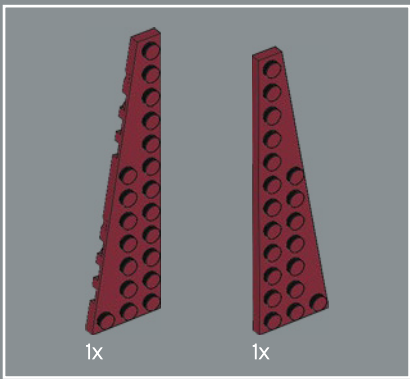

8

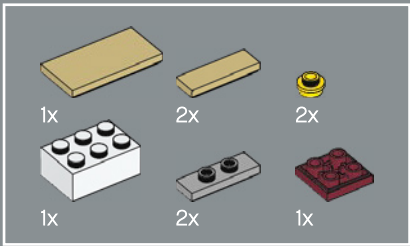
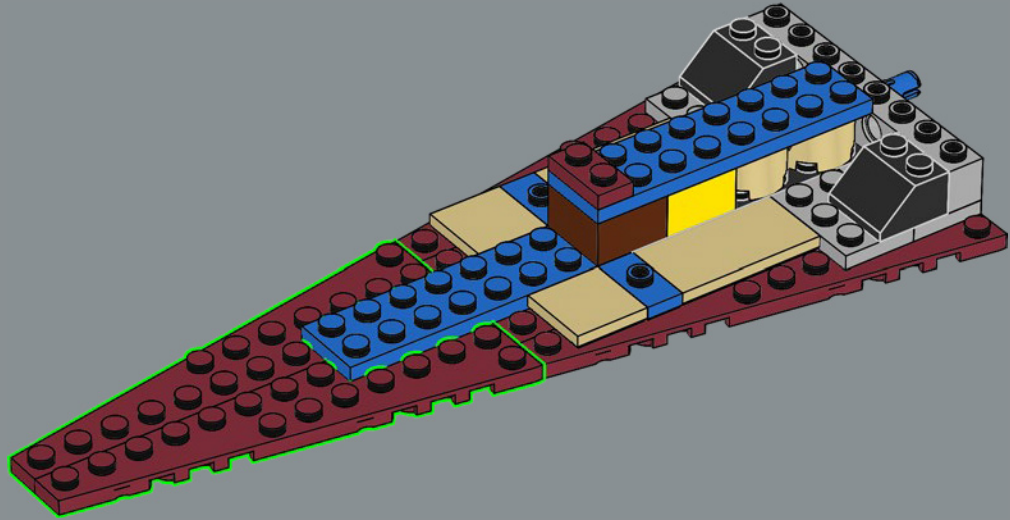

9

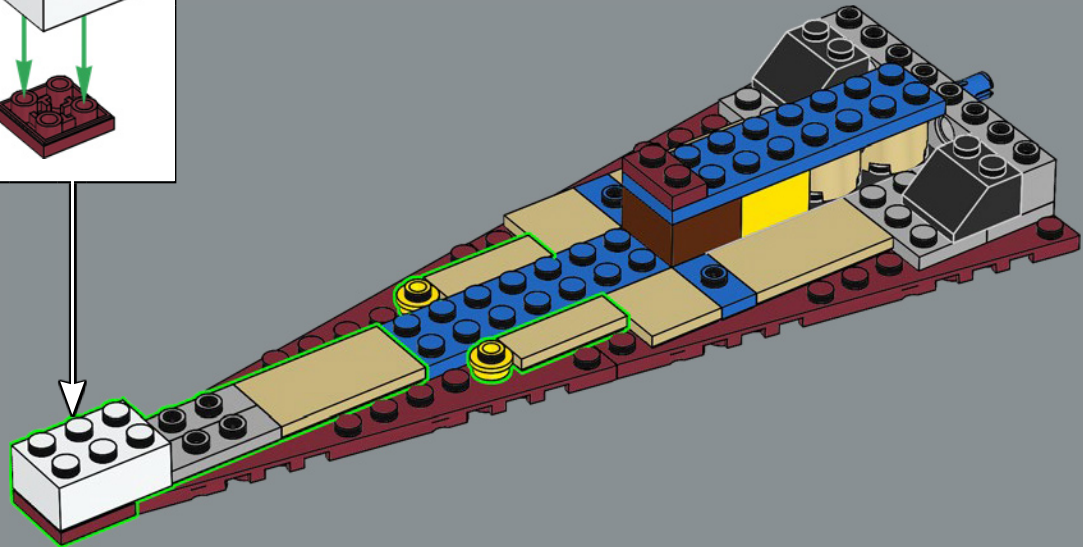
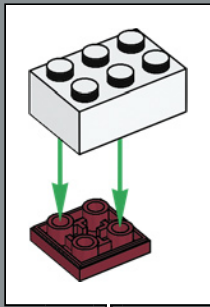

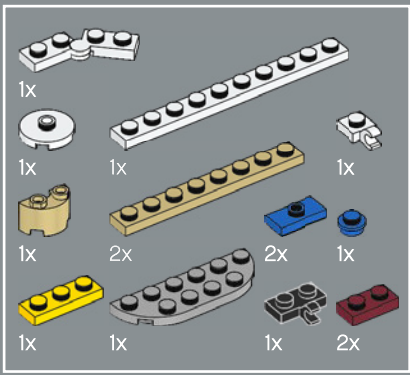

10

1

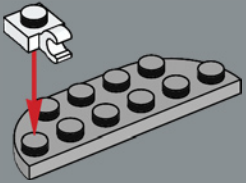

2

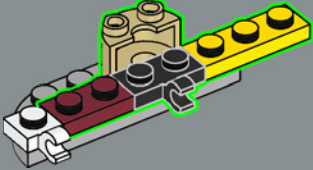

3

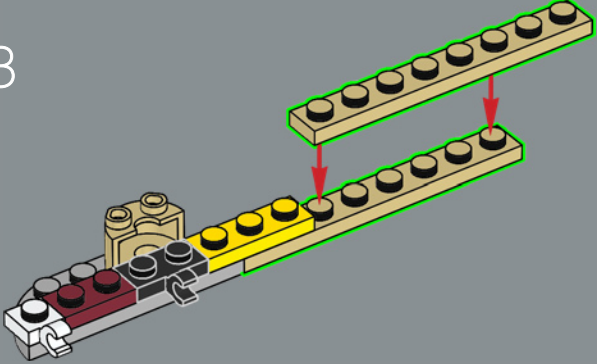

4

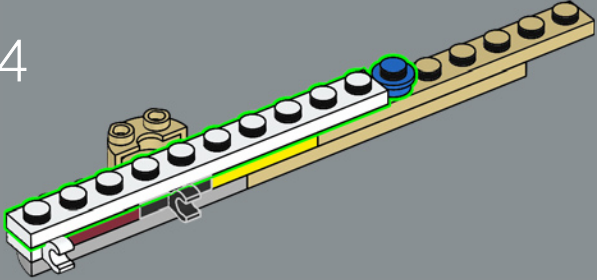

5

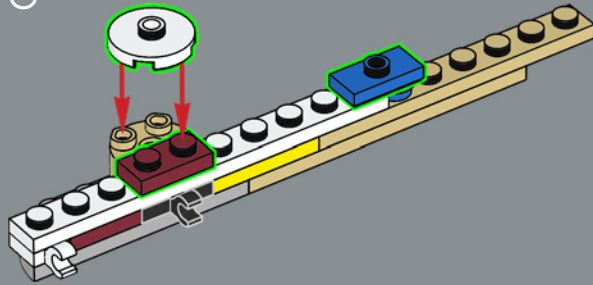

6

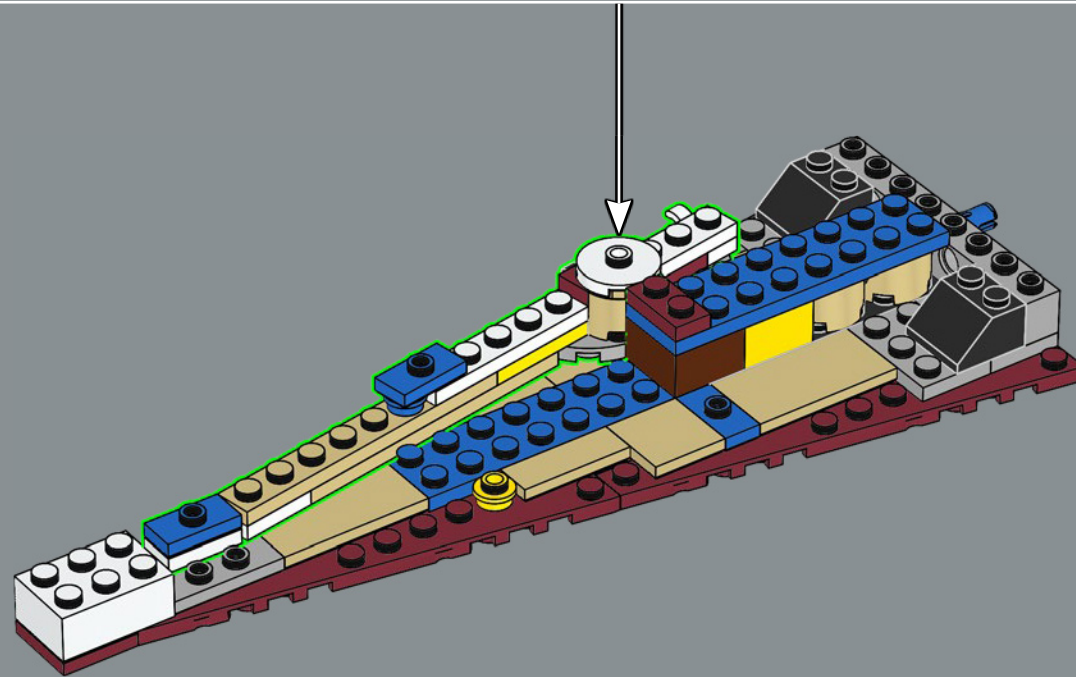
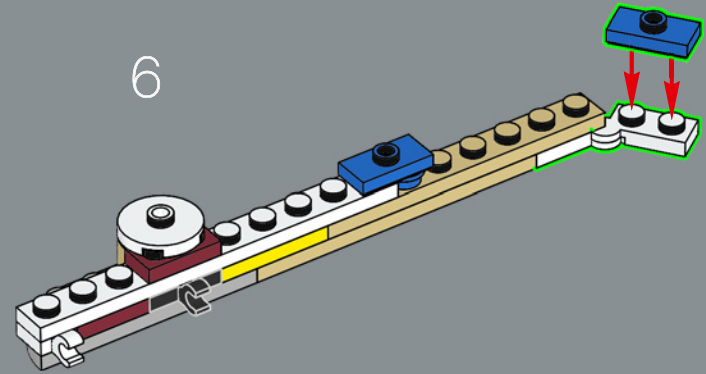

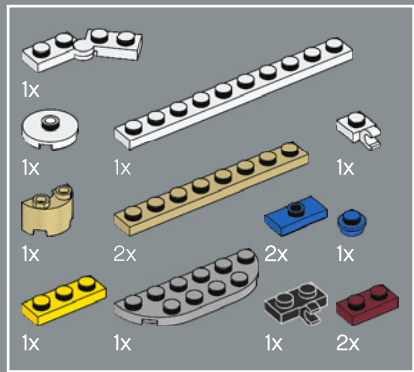

11

1

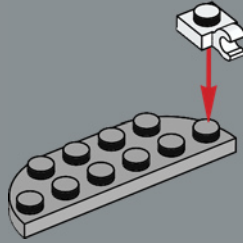

2

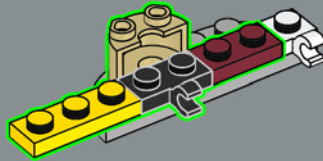

3

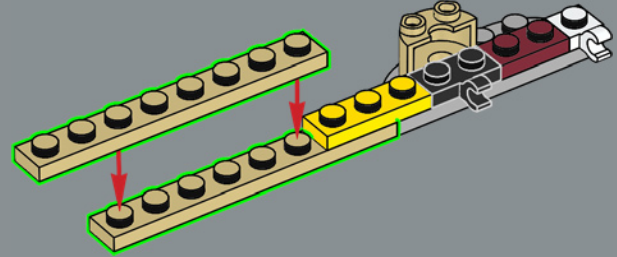

4

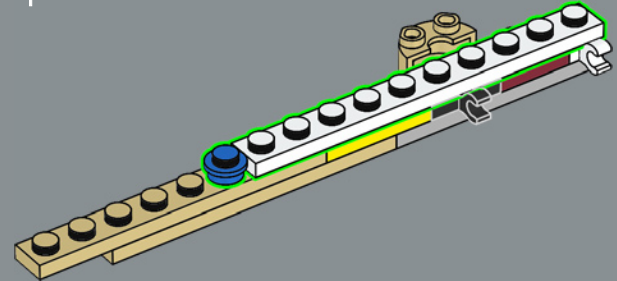

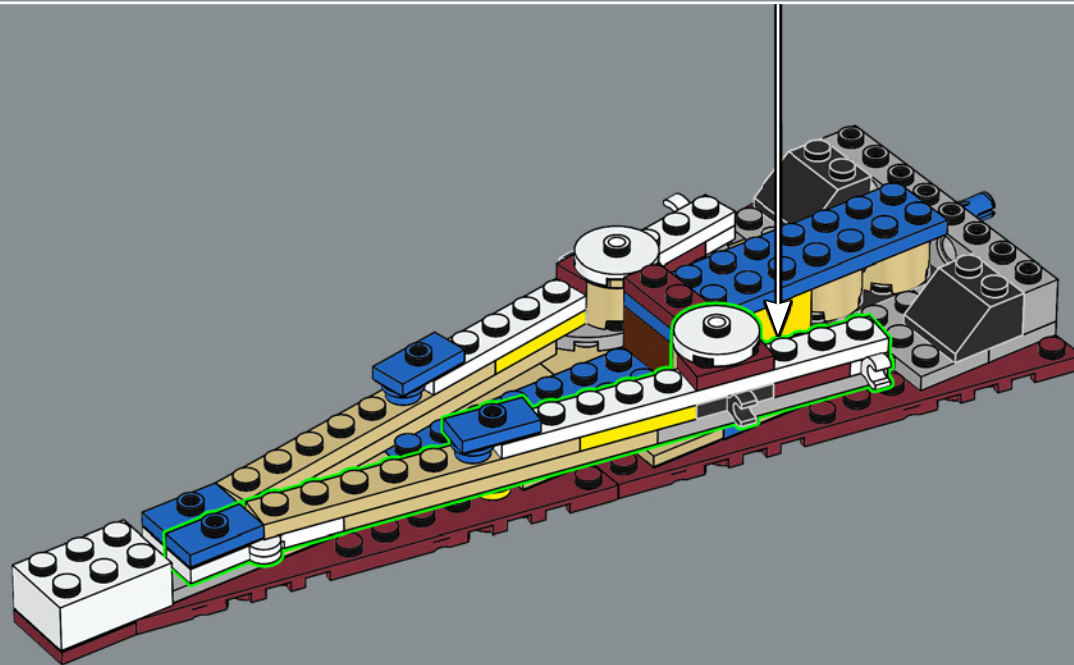
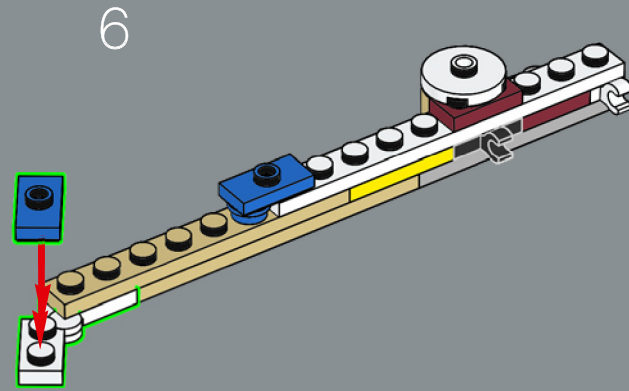
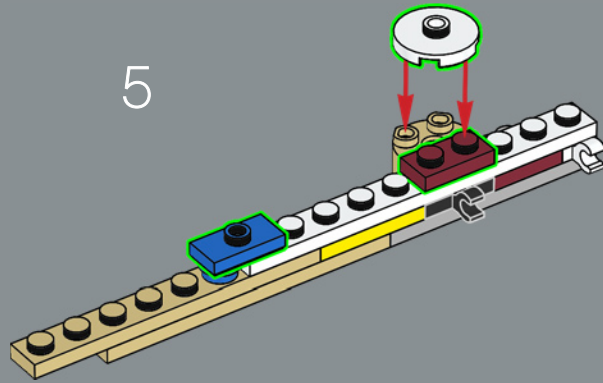

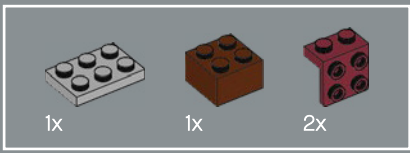

12

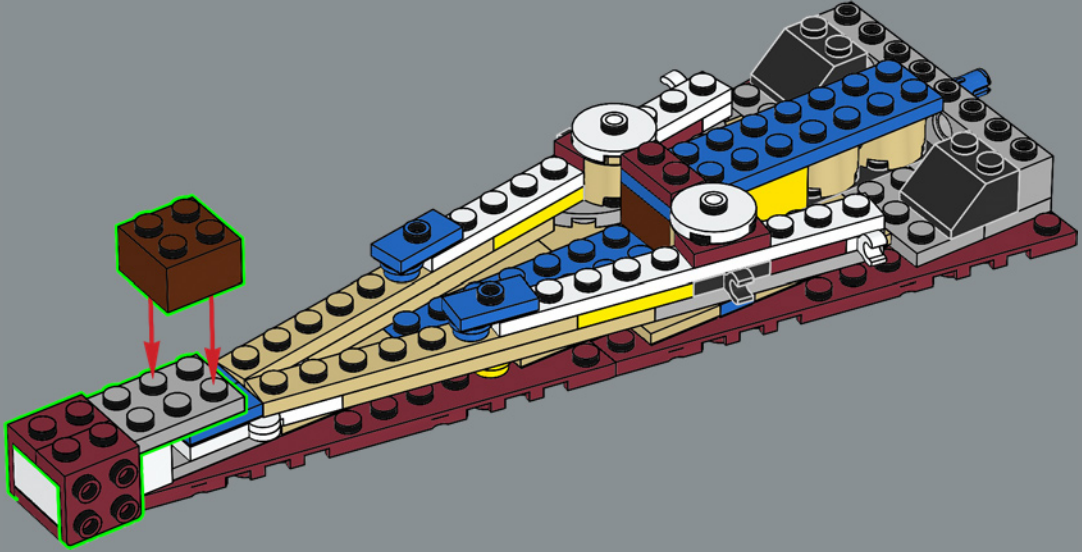

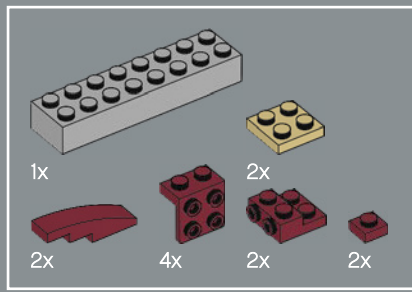

13

1

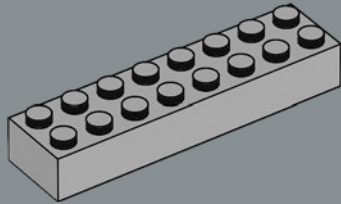

2

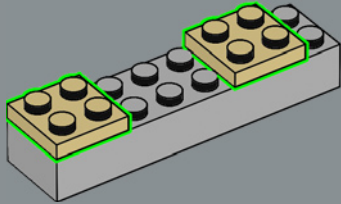

3

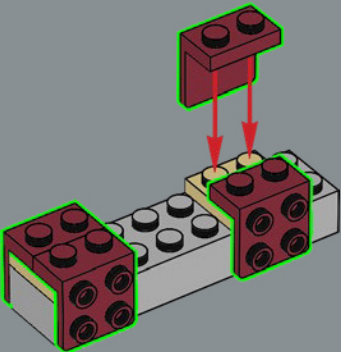

4

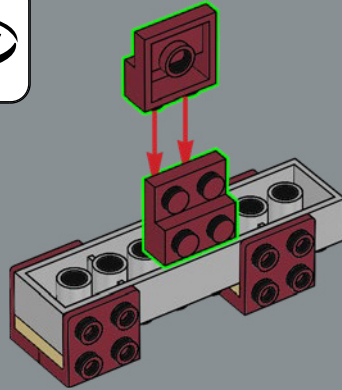

5

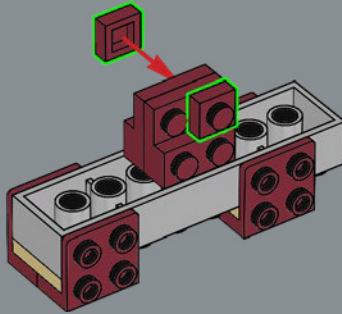

6

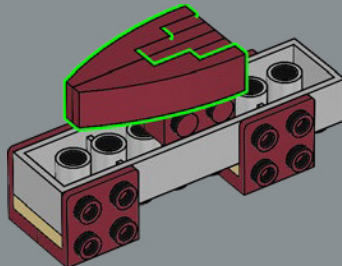

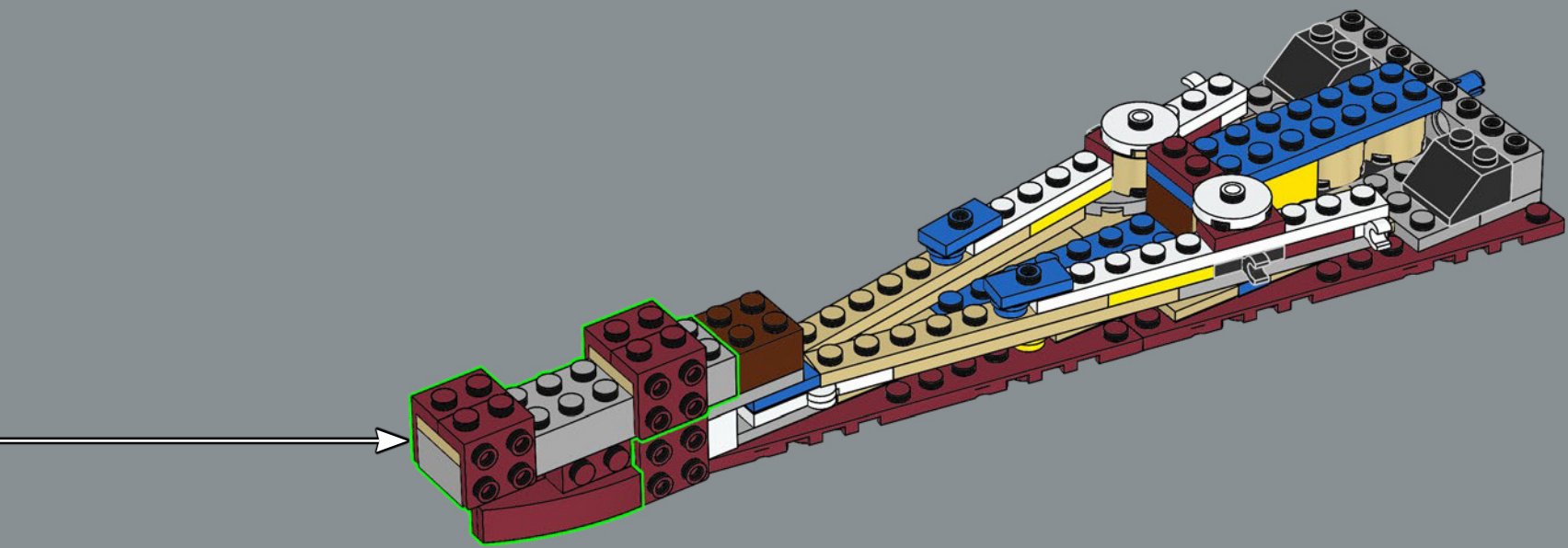

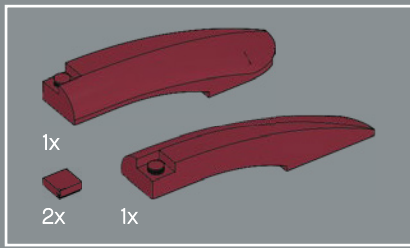

14

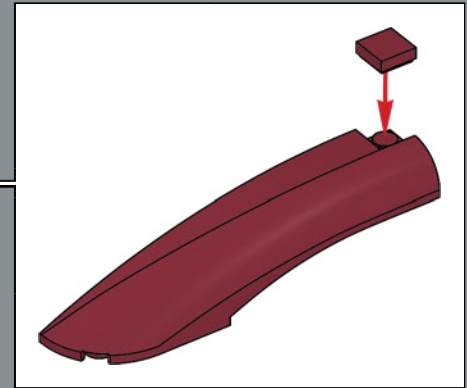
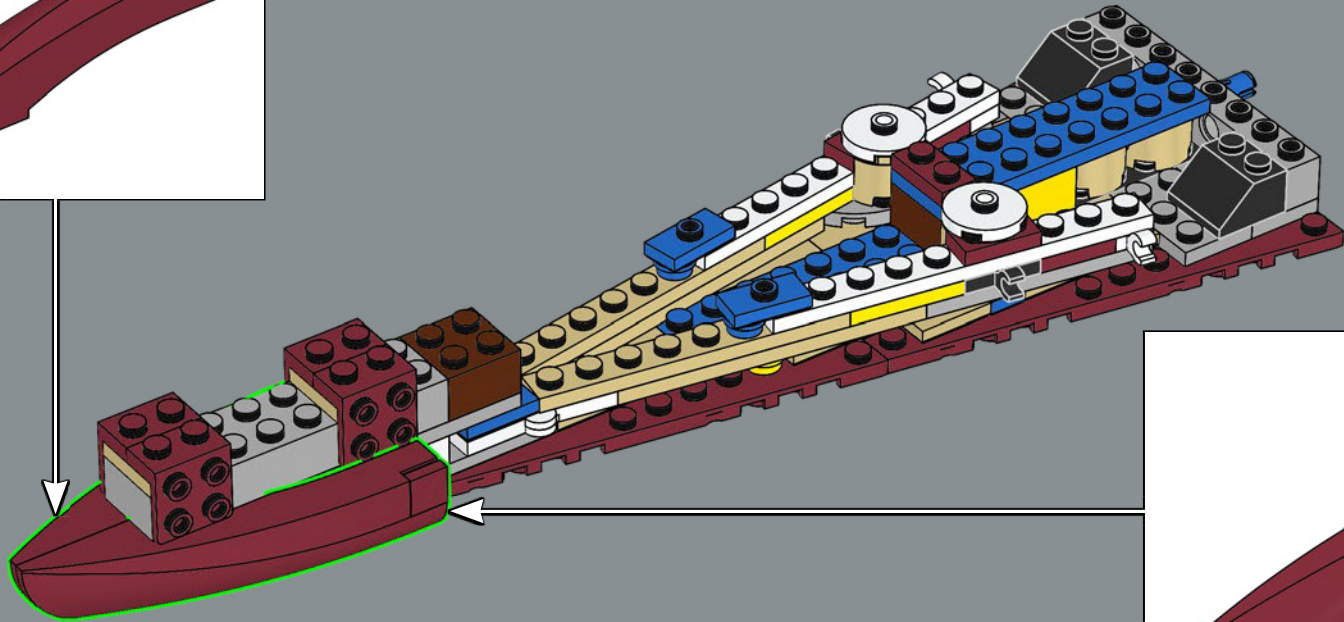
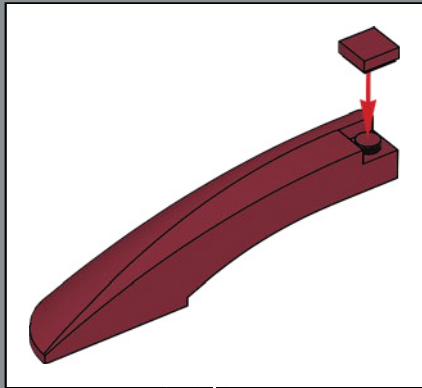

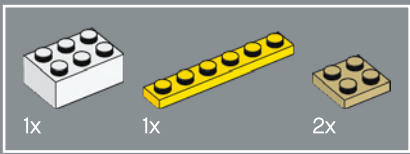

15

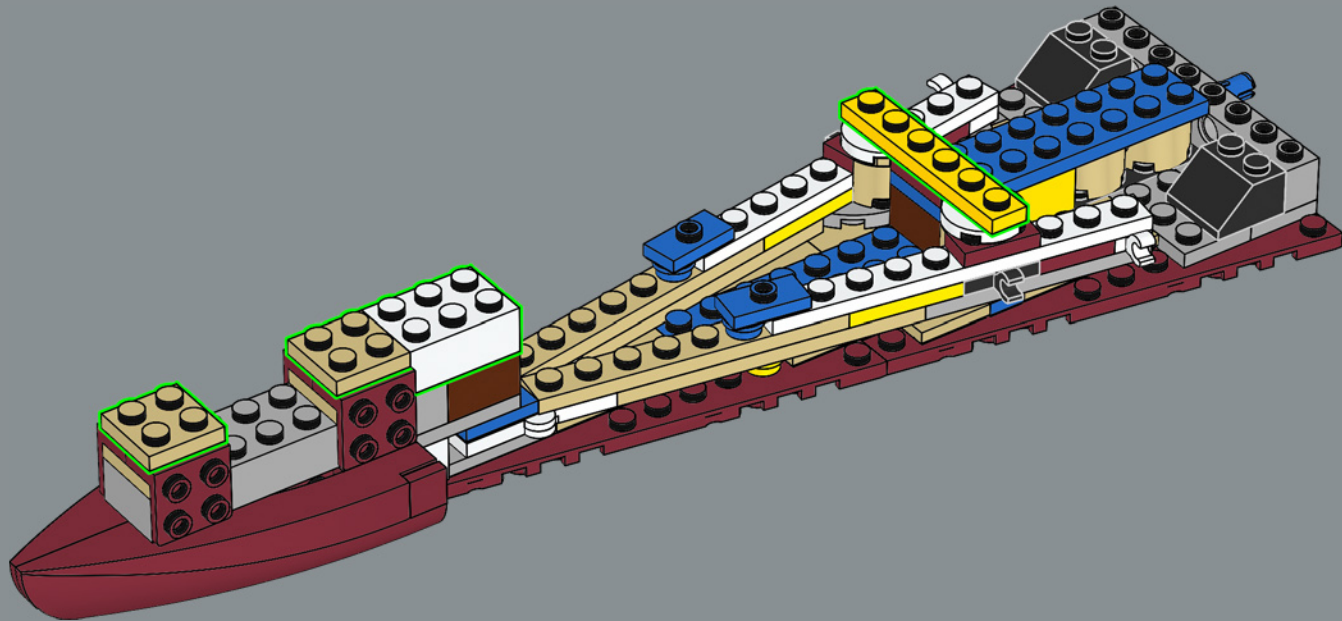

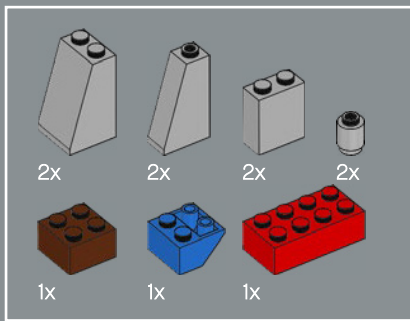

16

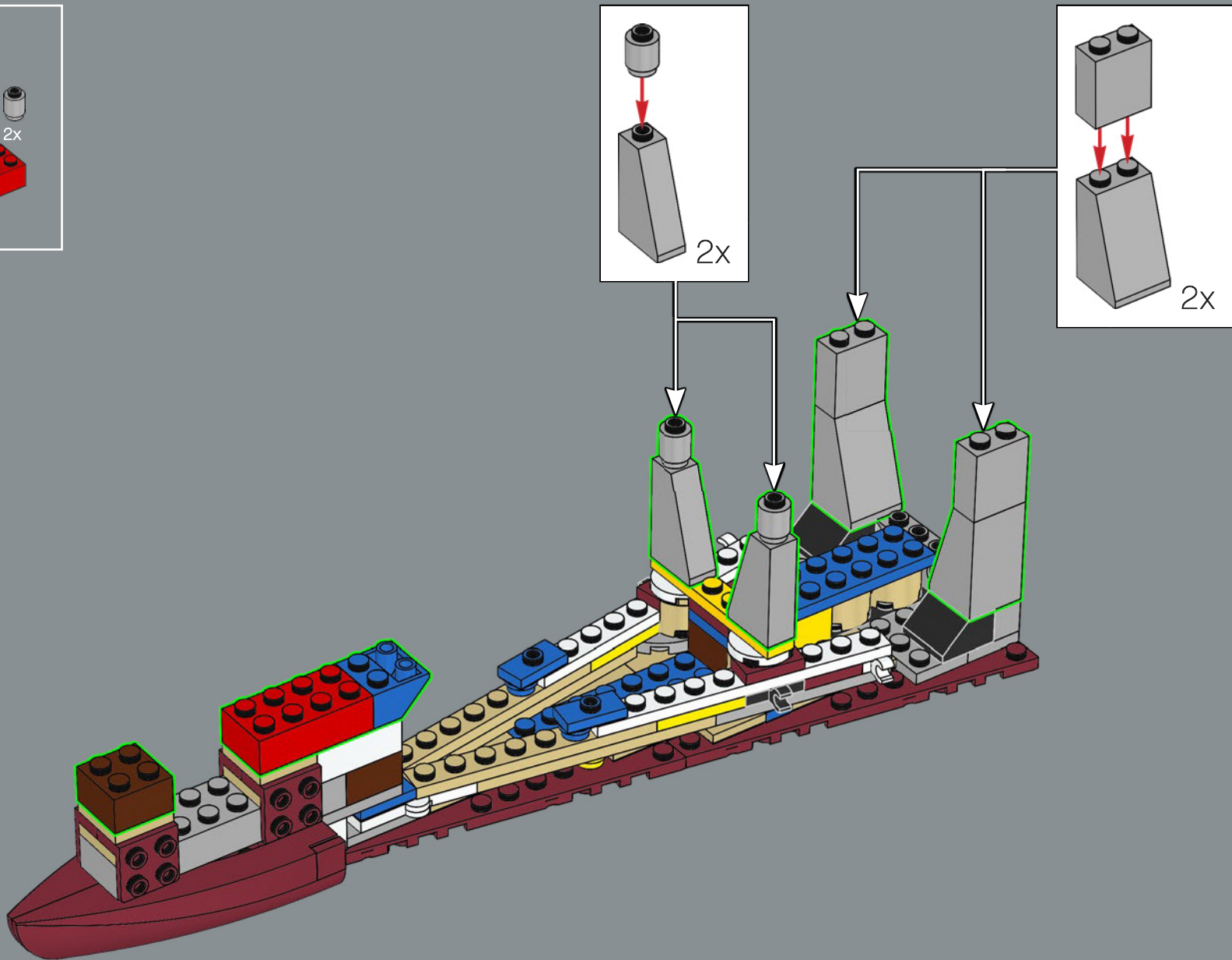

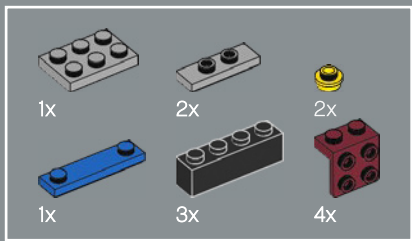

17

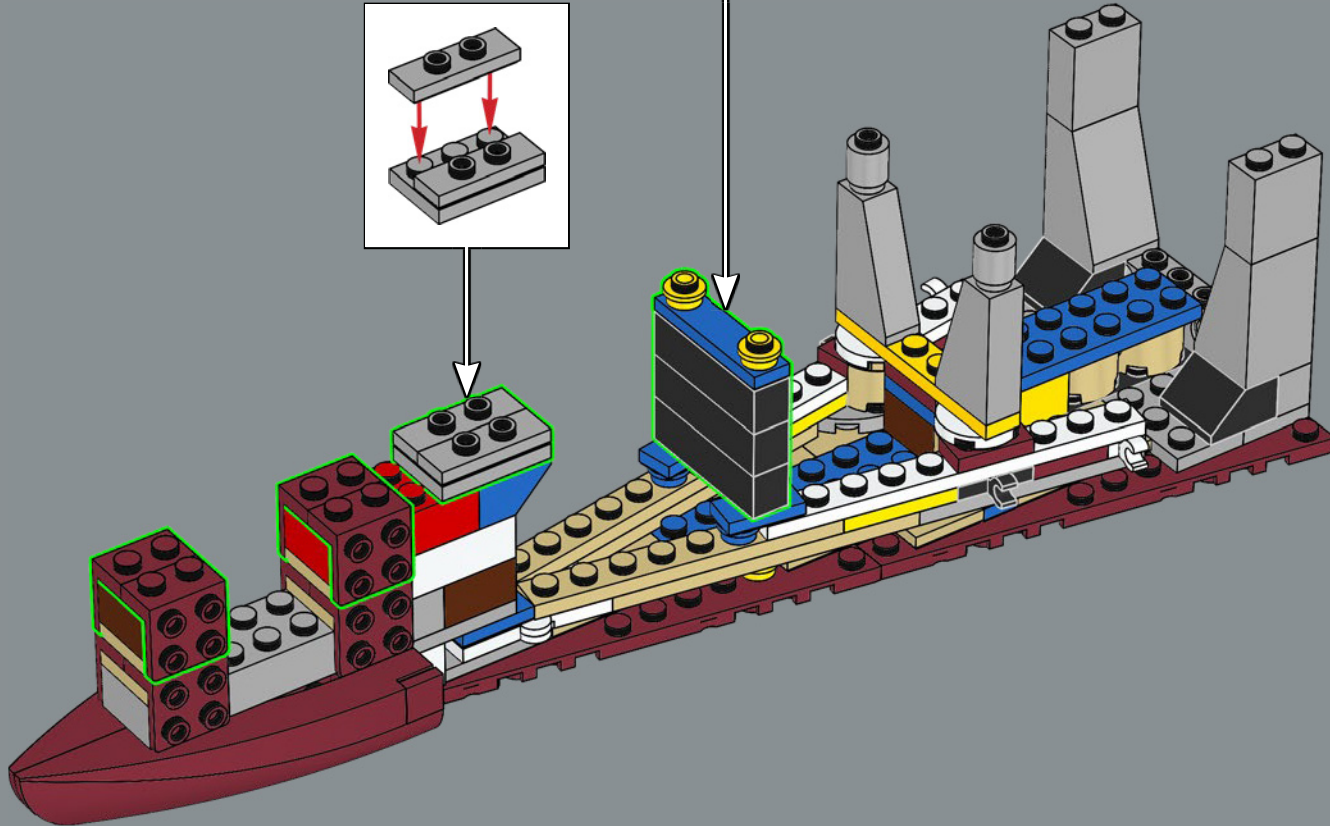
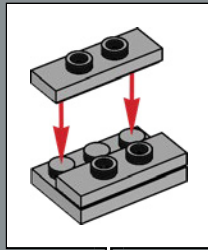
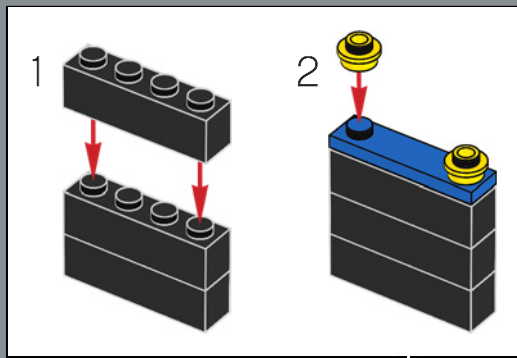

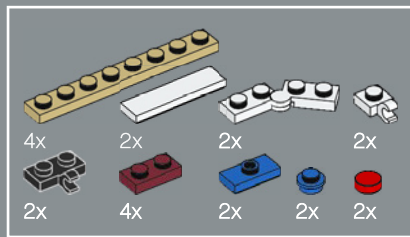

18

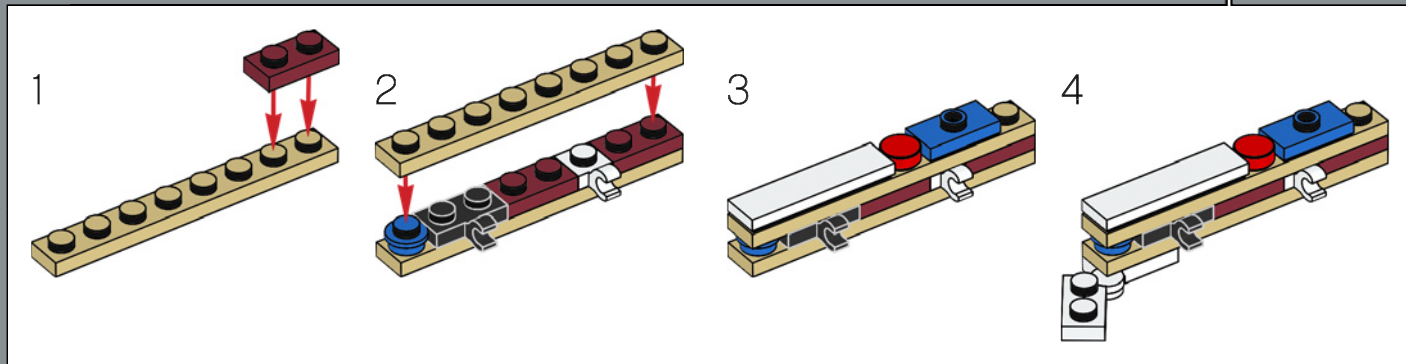
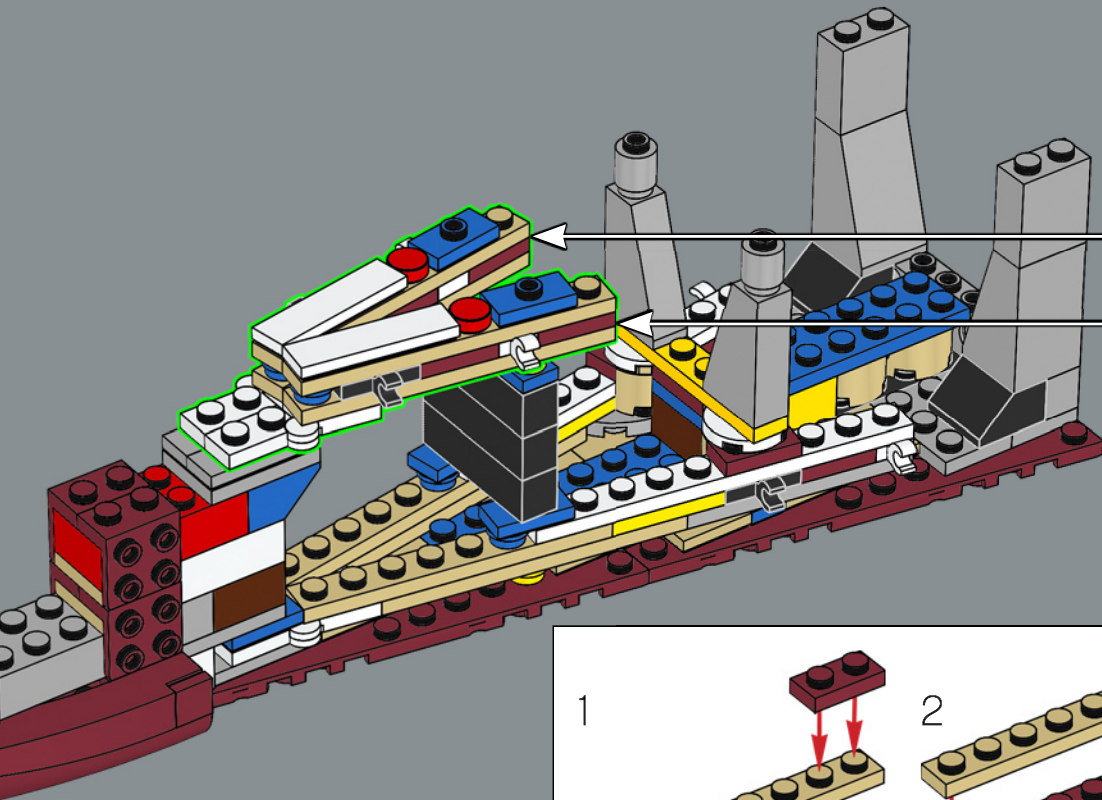
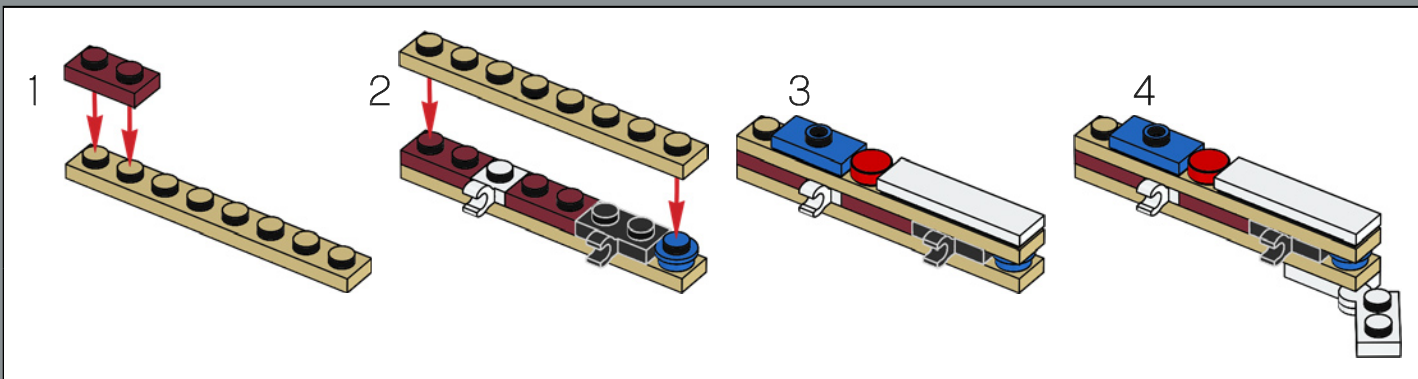

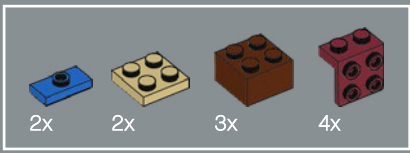

19

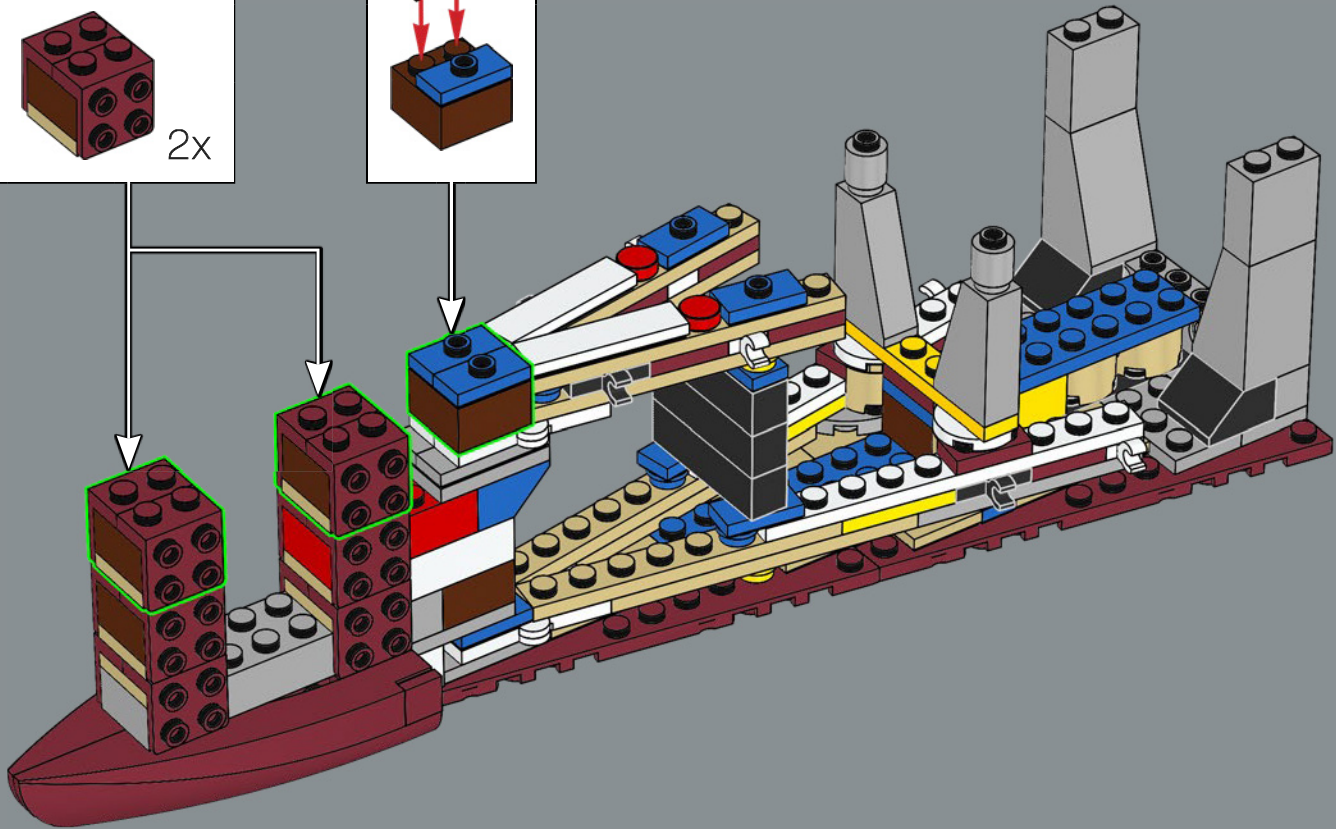
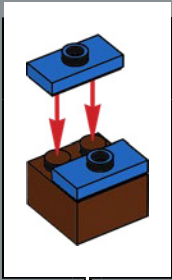
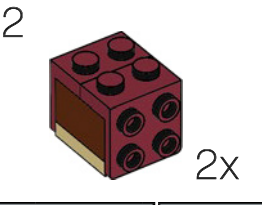
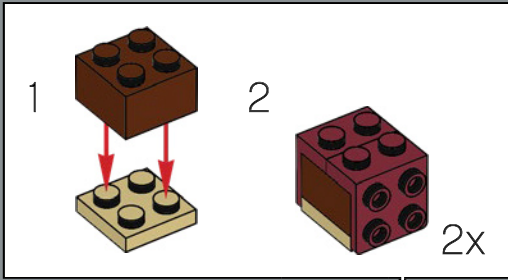

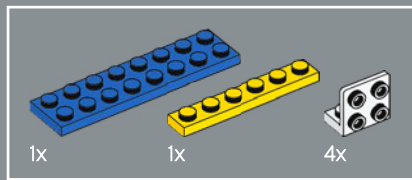

20

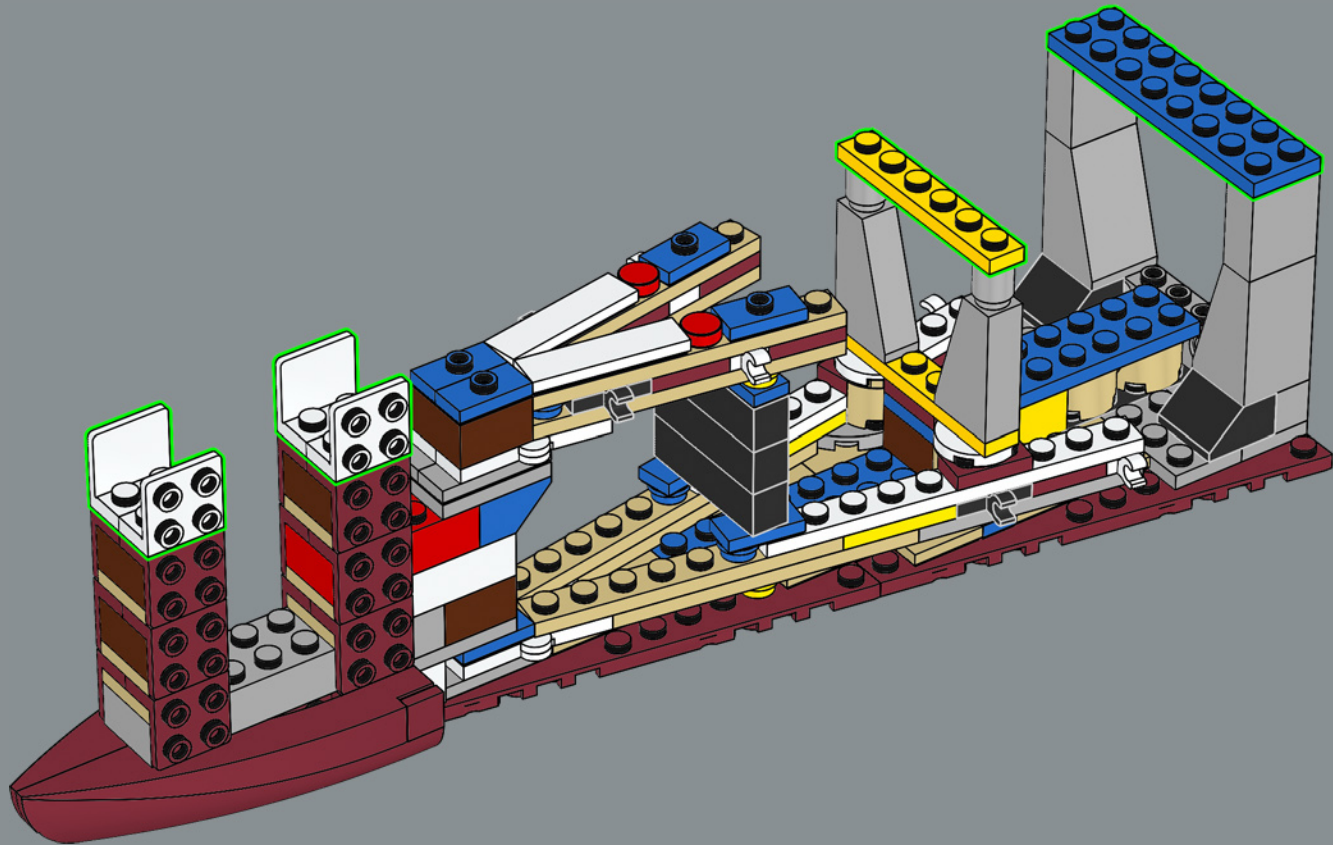

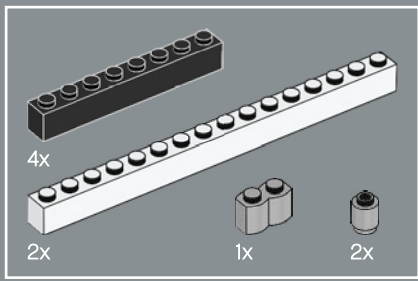

21

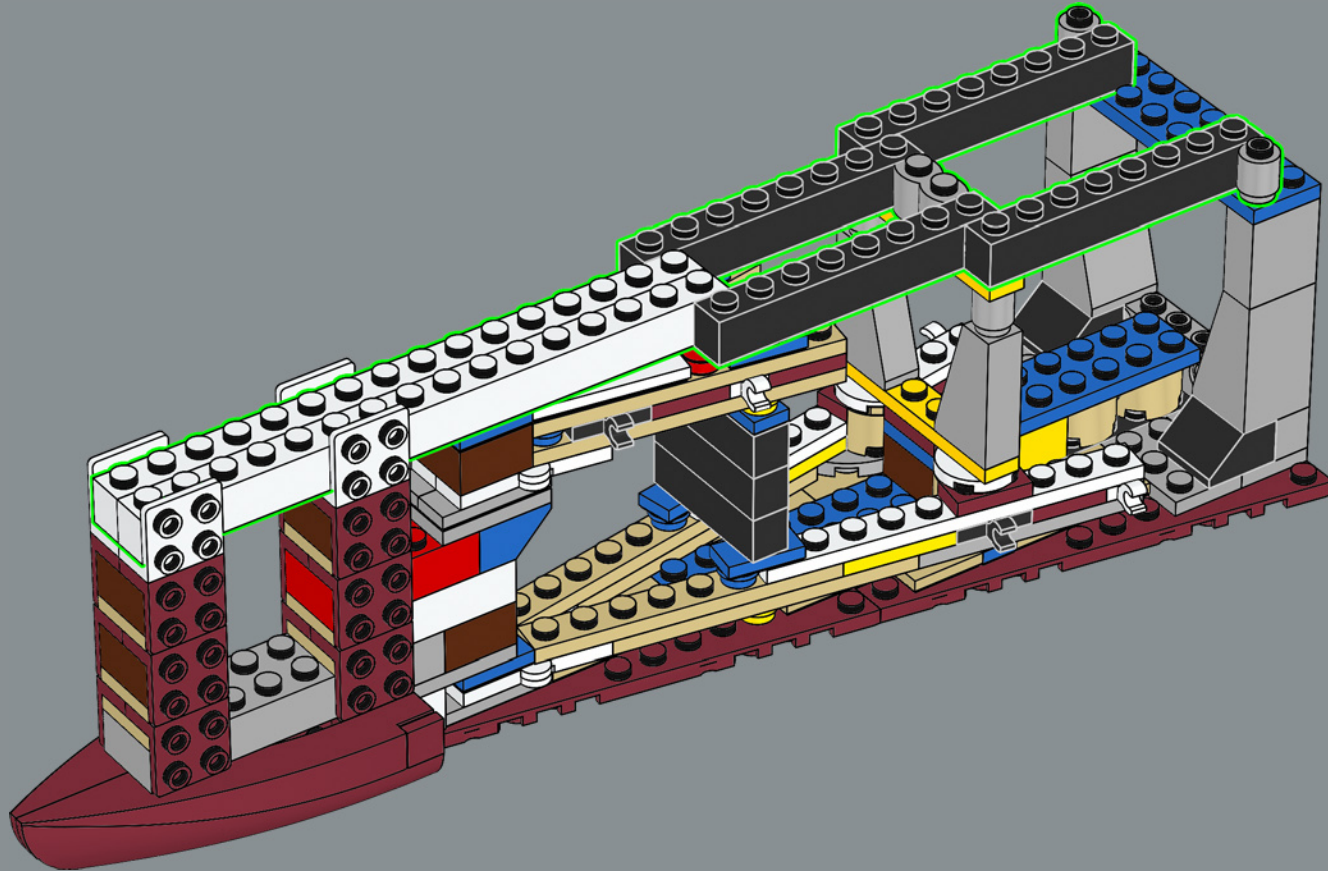

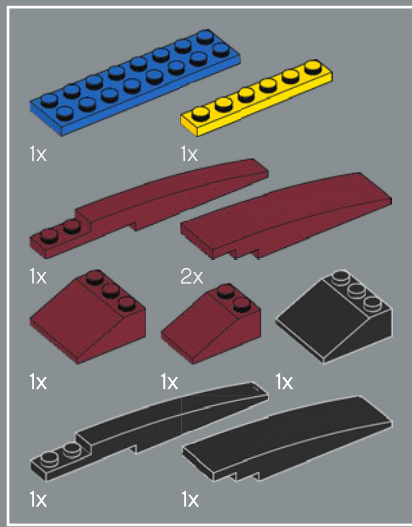

22

1

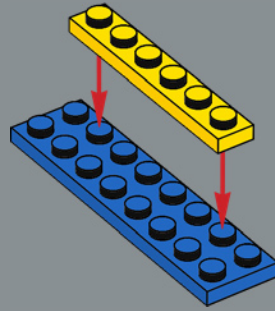

2

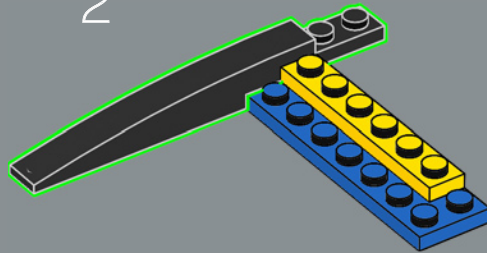

3

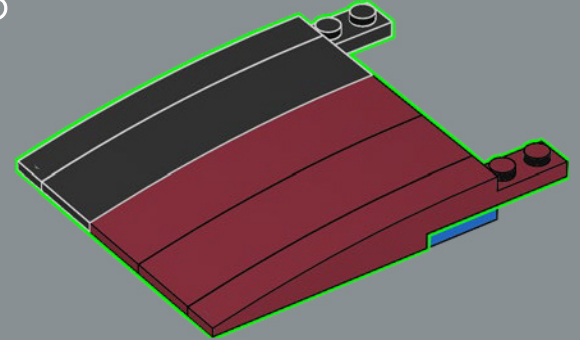

4

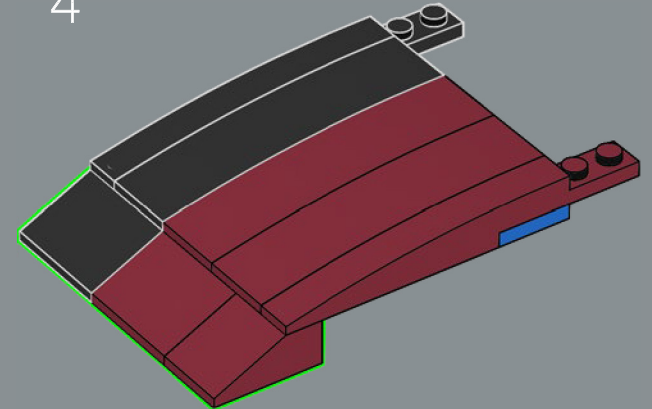

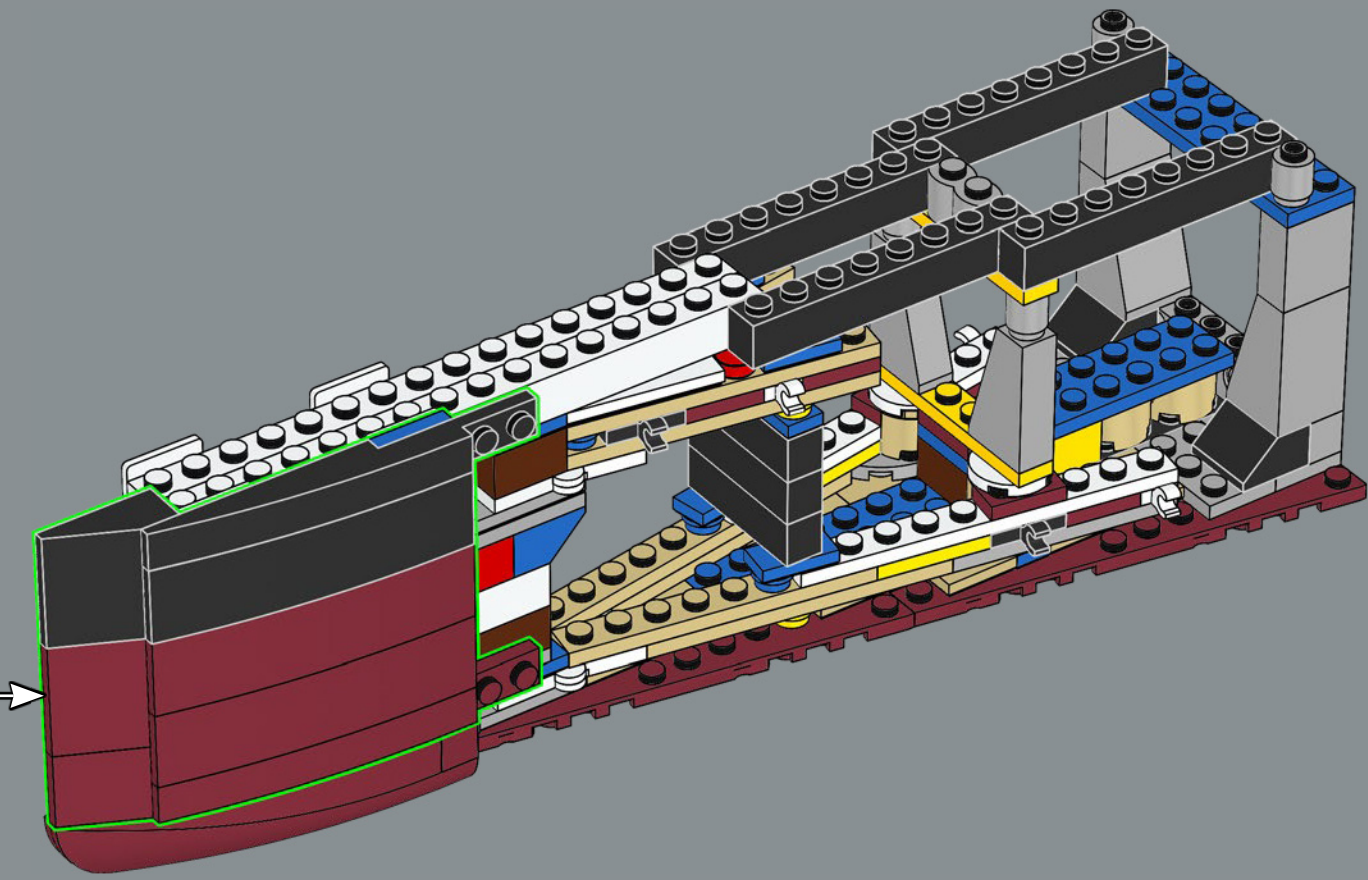

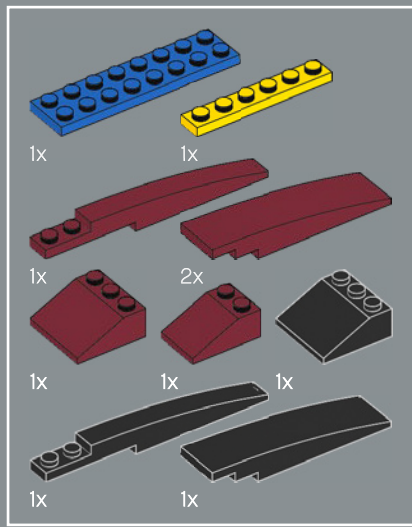

23

1

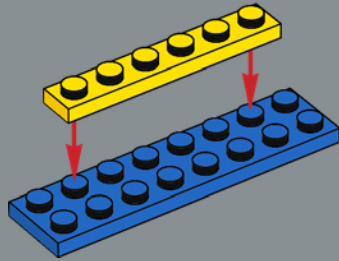

2

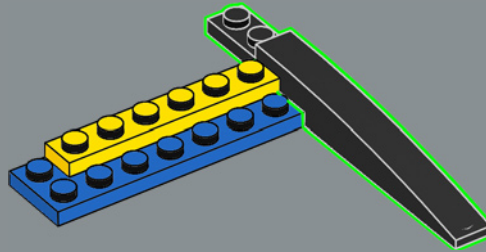

3

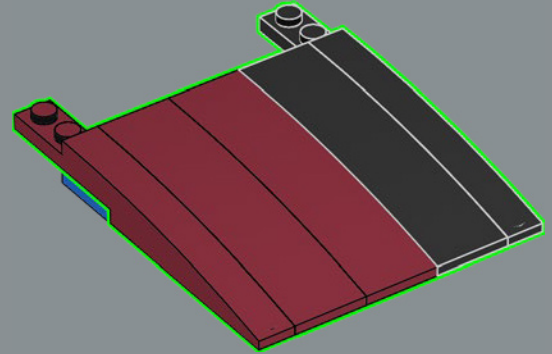

4

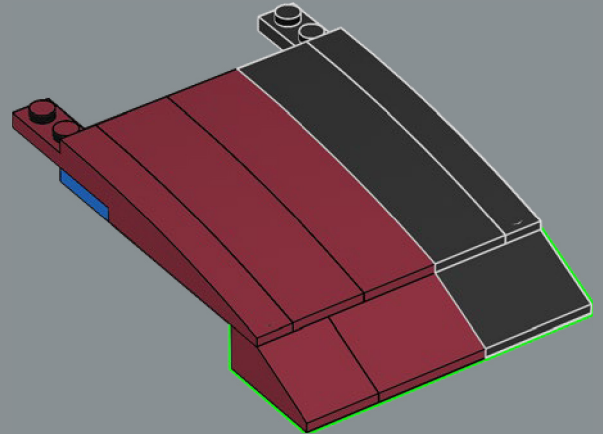

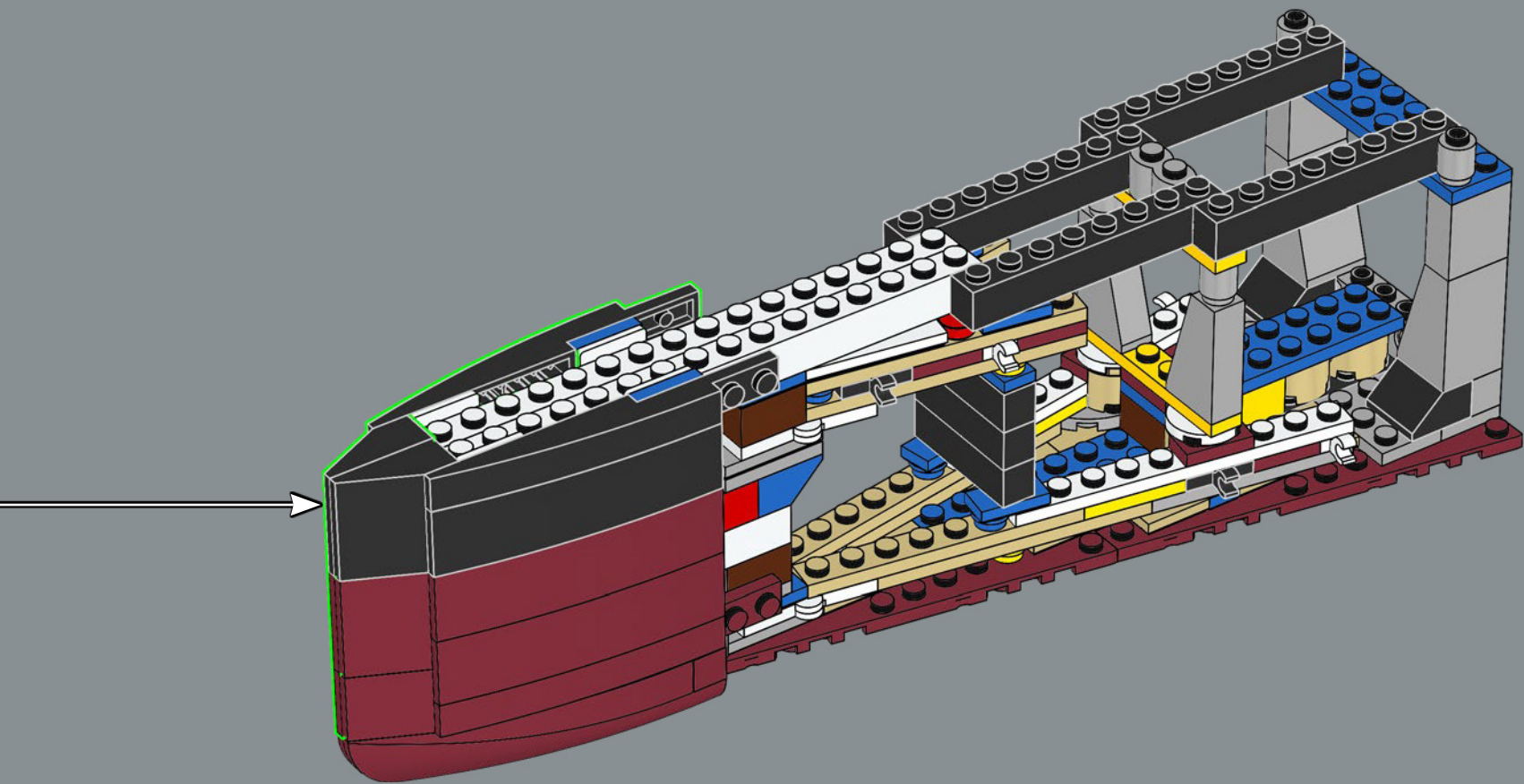

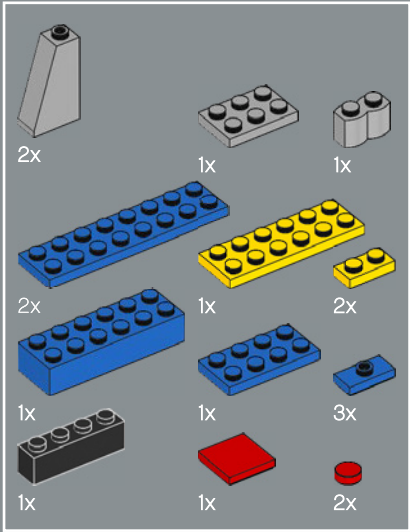
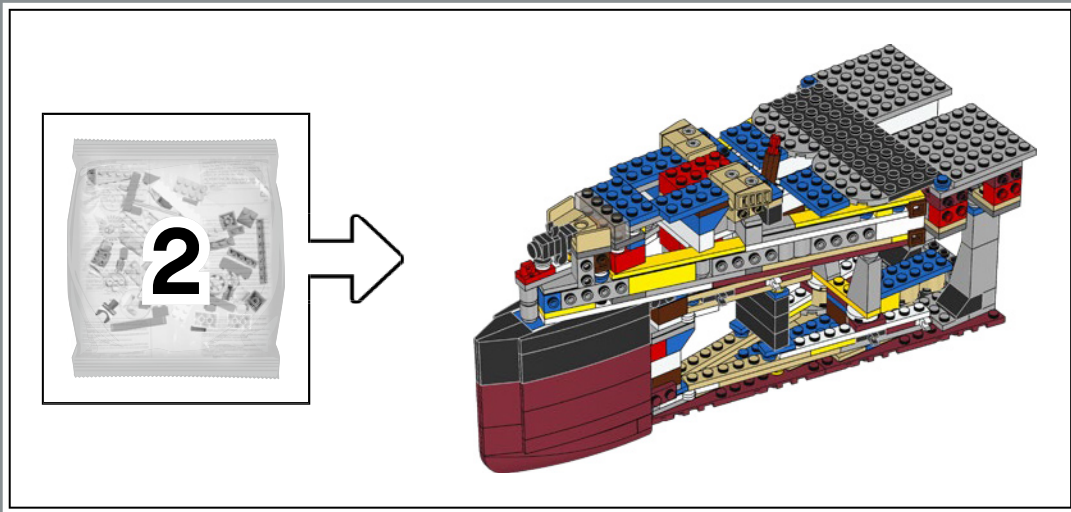

24

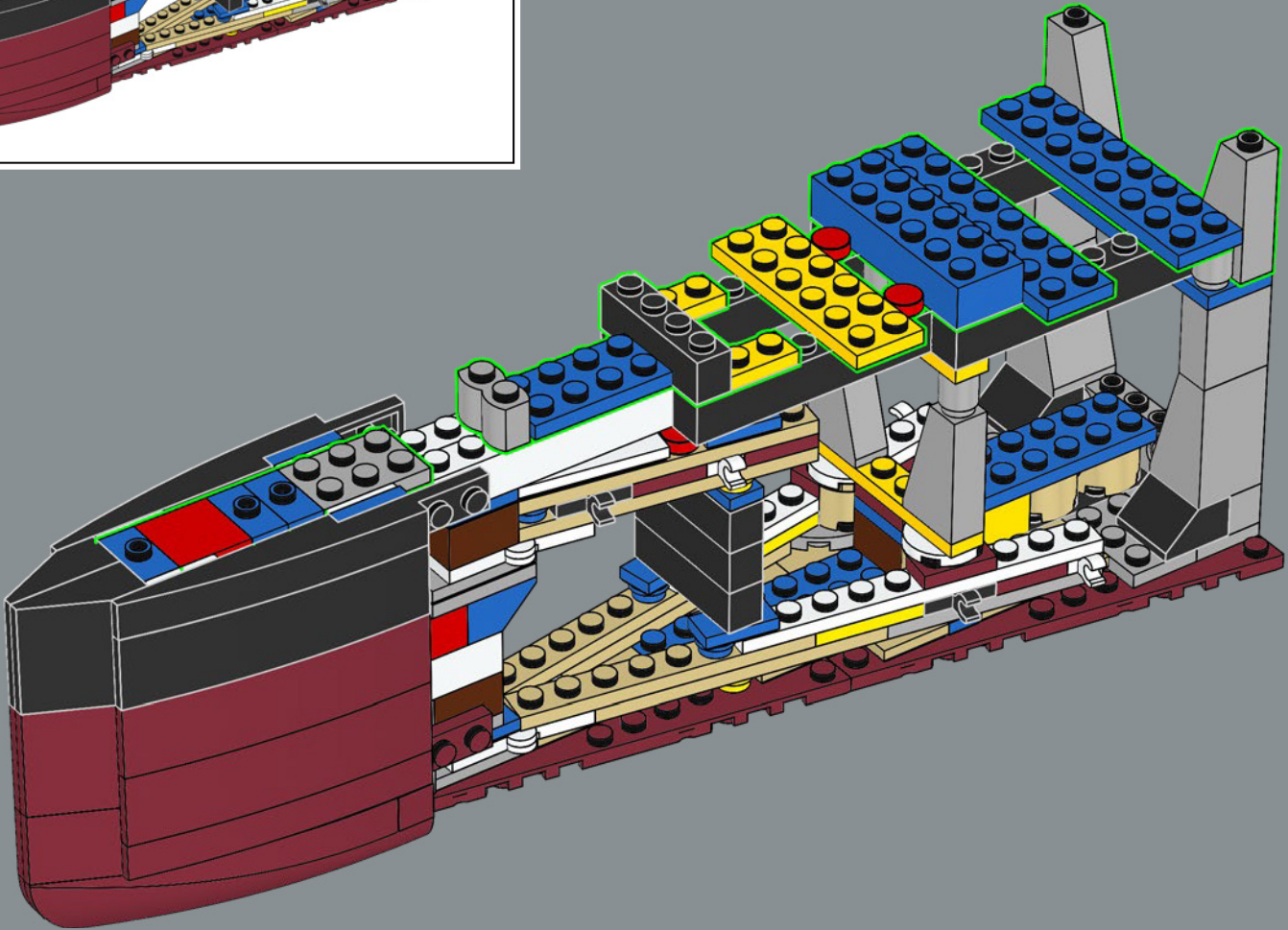

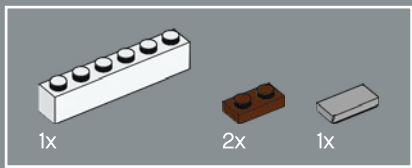

25

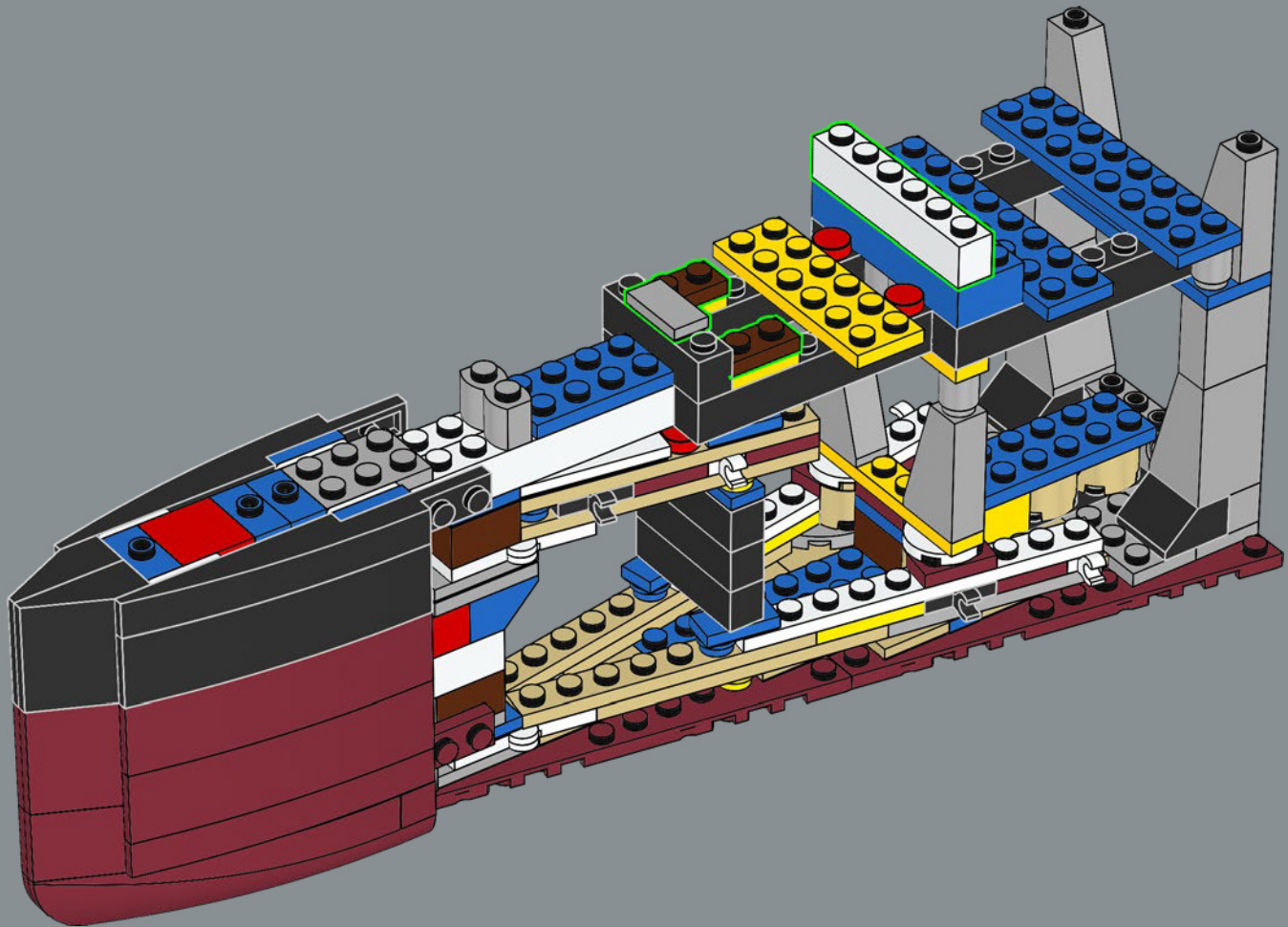

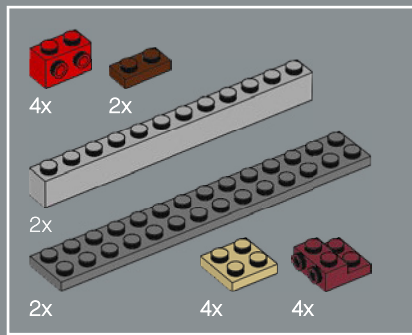

26

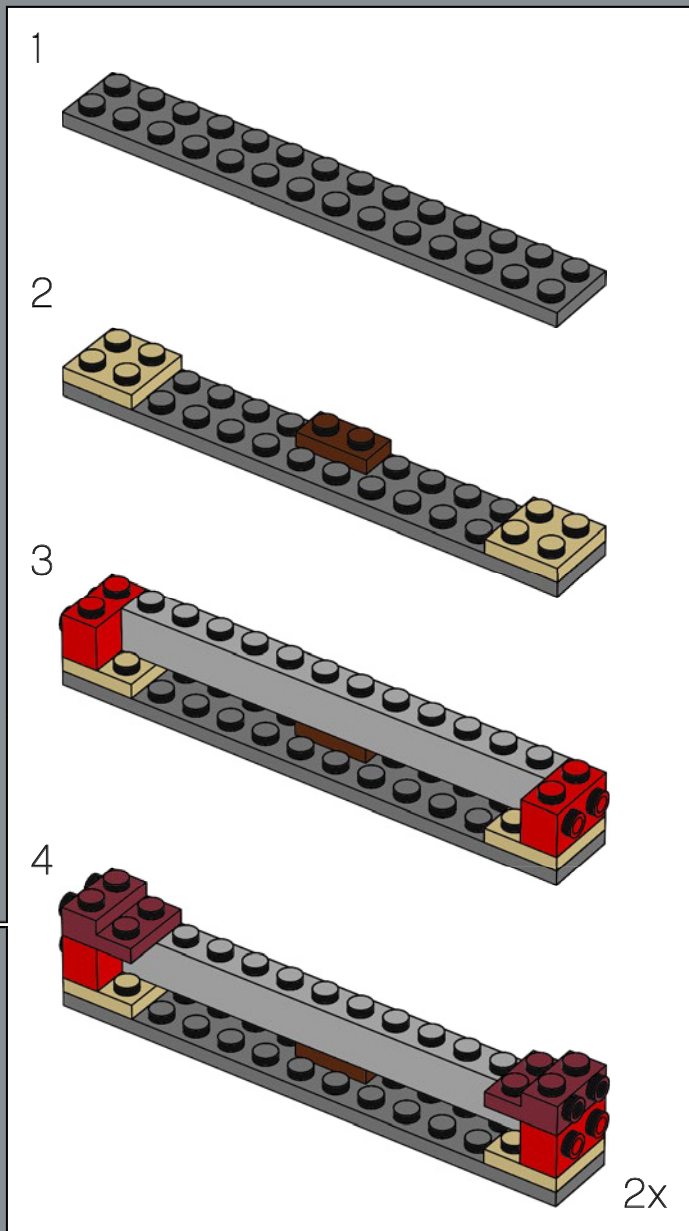
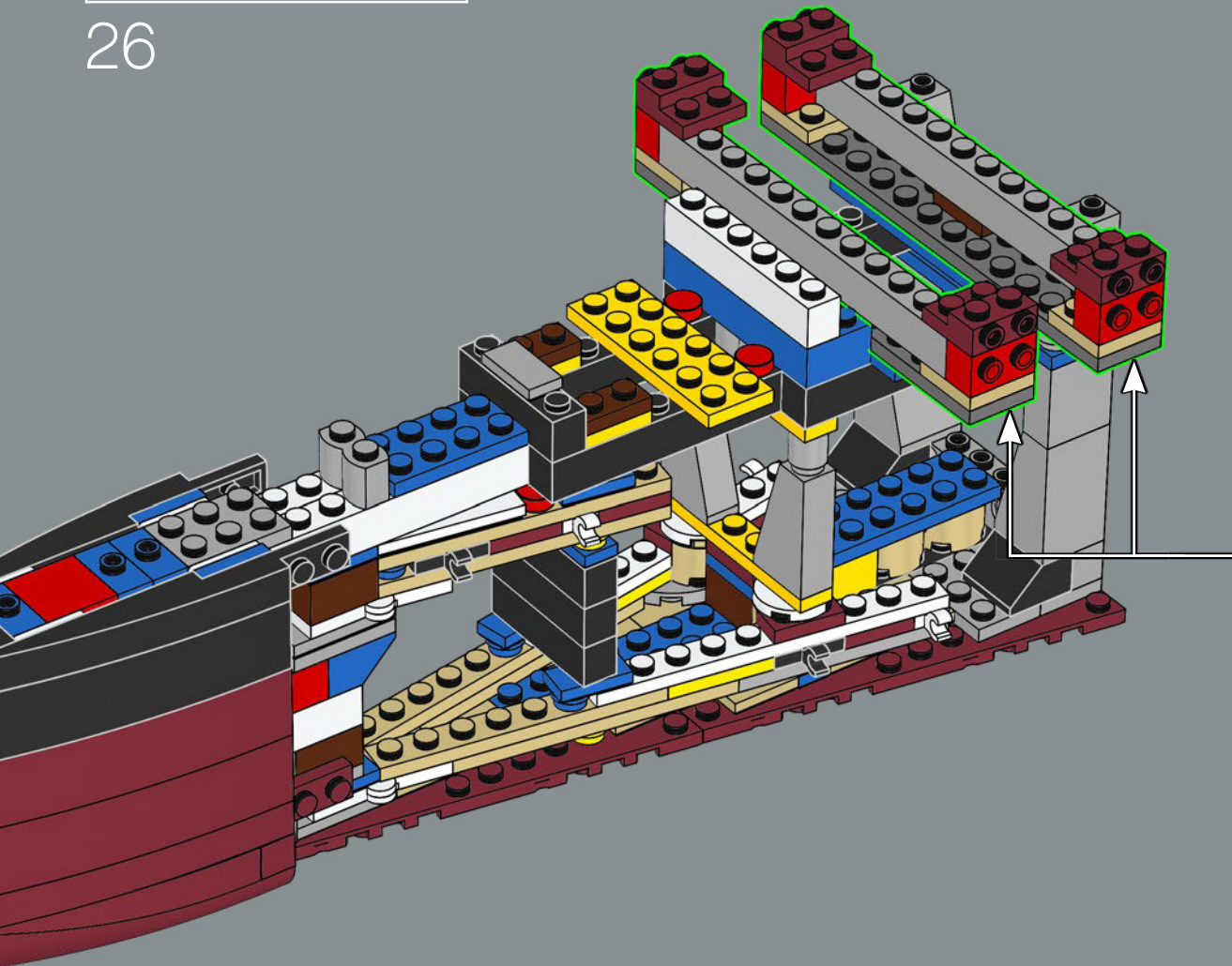

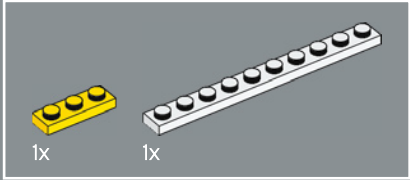
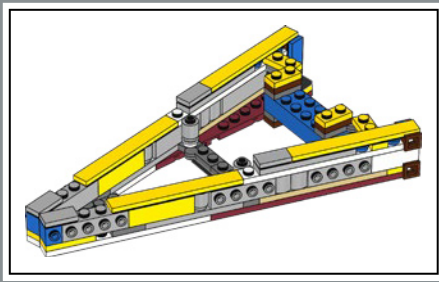

27

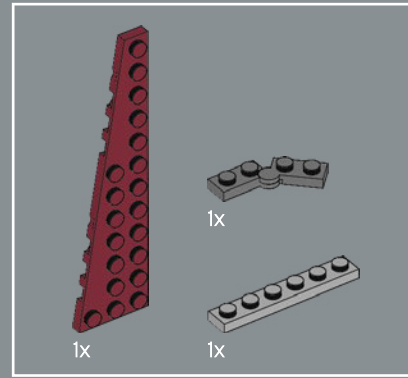
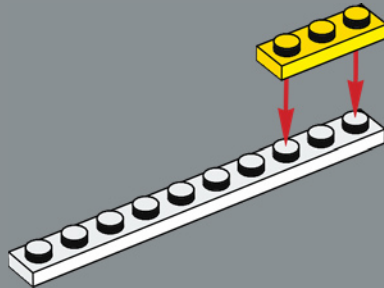

28

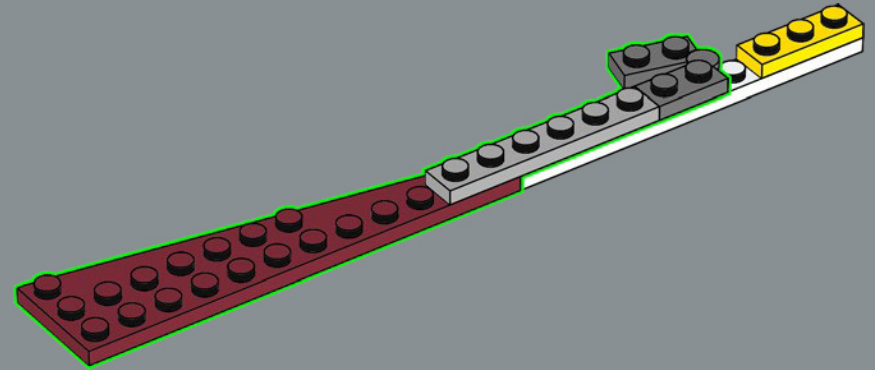

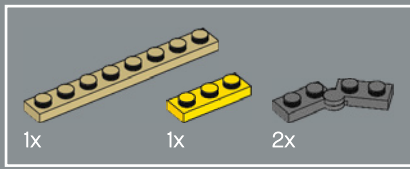

29

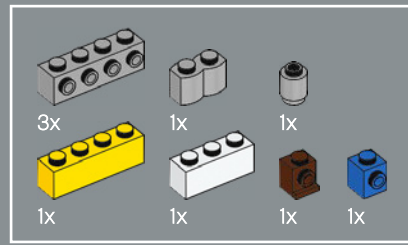
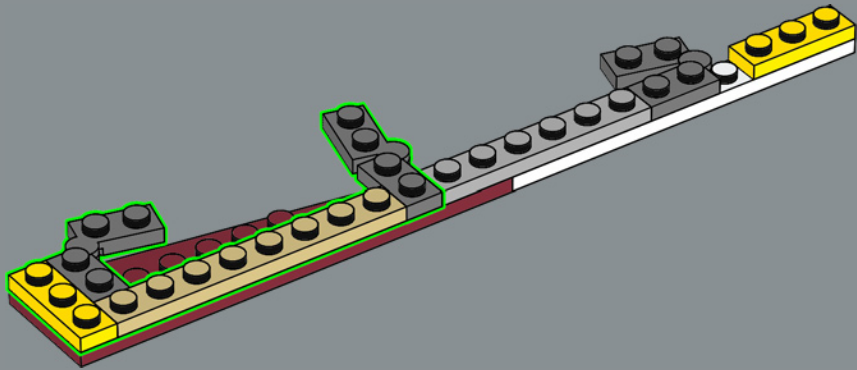

30

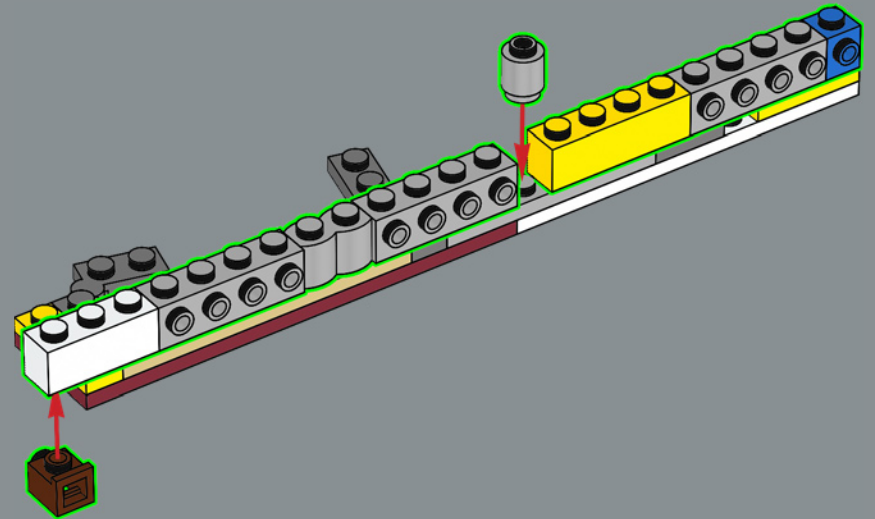

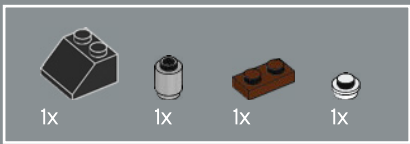

31

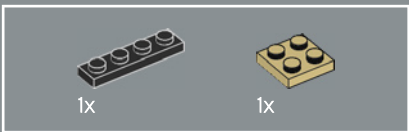
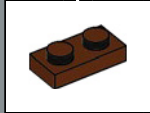
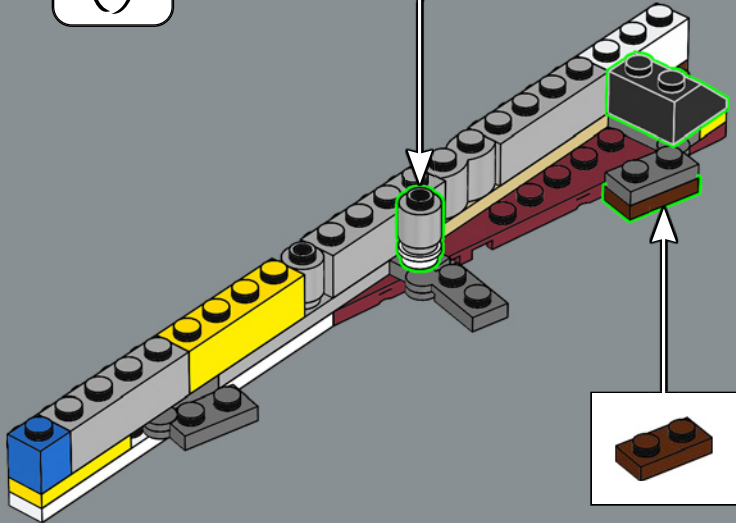
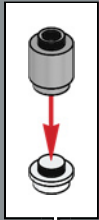

32

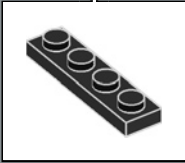
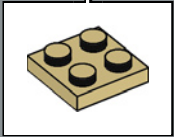
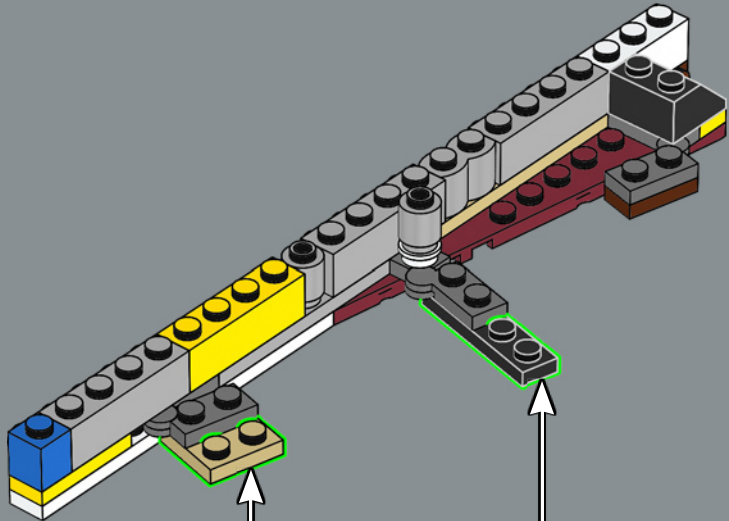

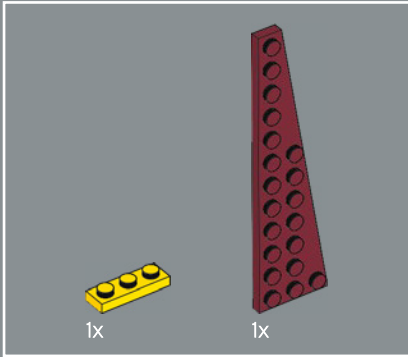
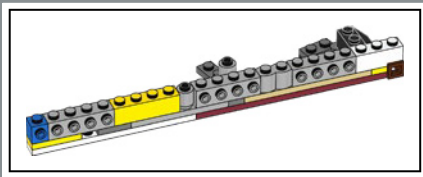

33

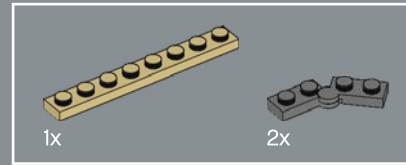
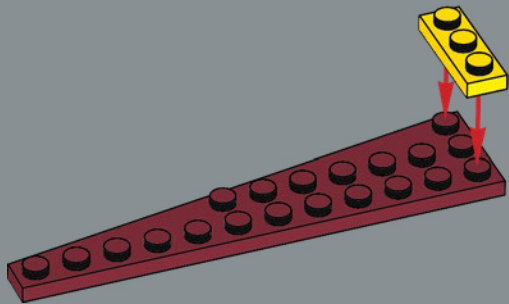

34

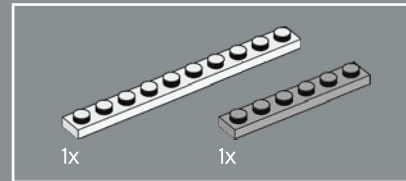
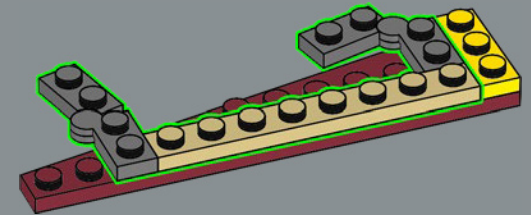

35

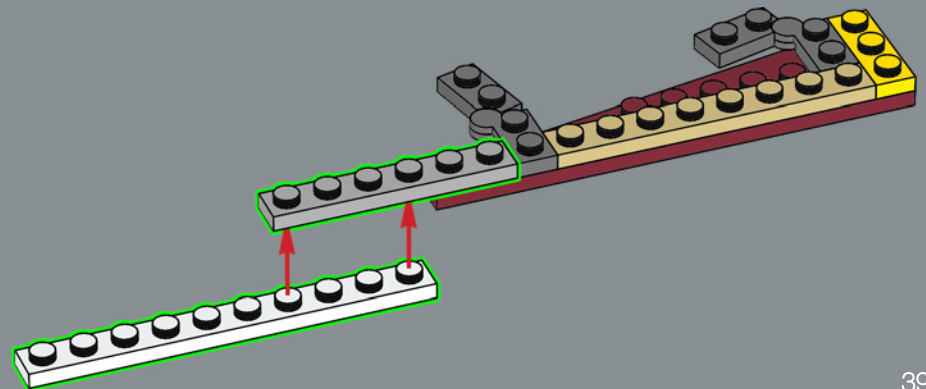

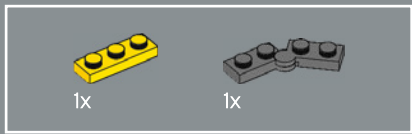

36

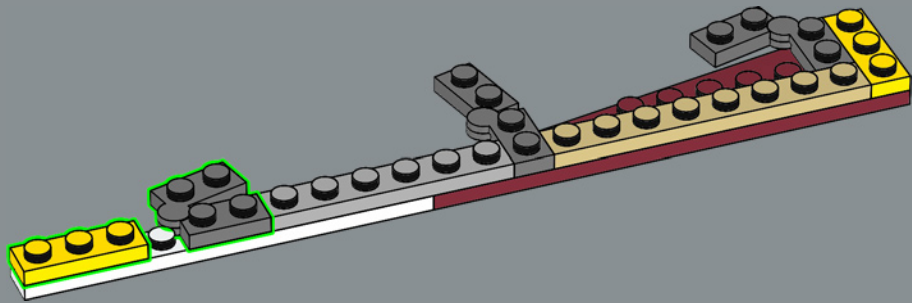

37

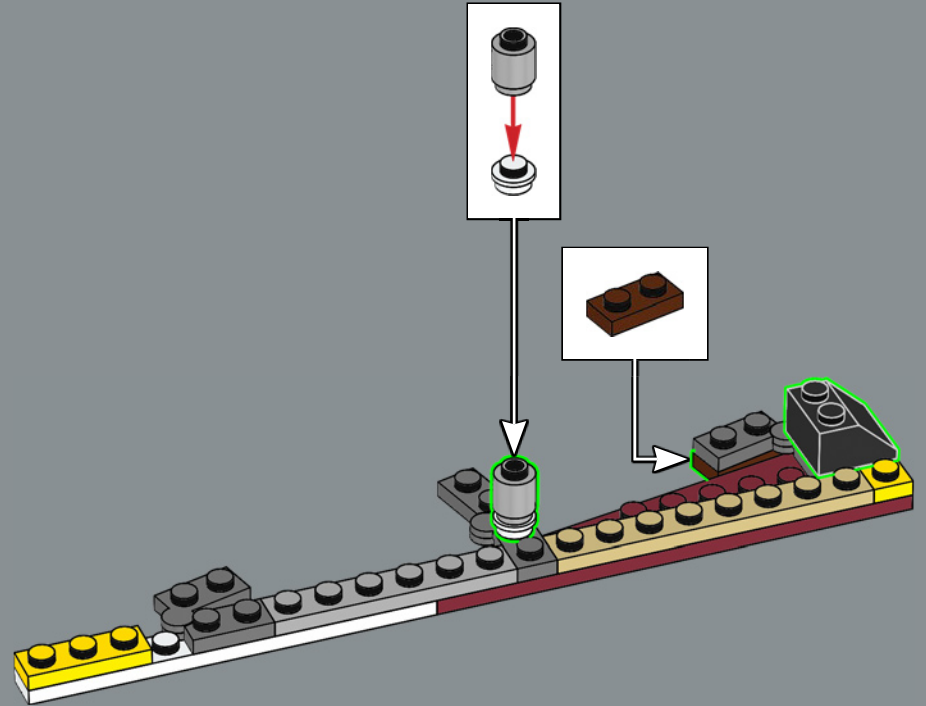

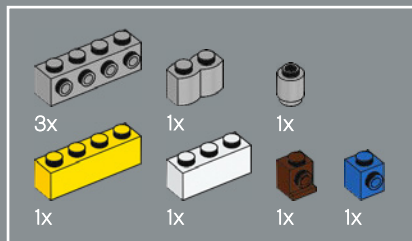

38

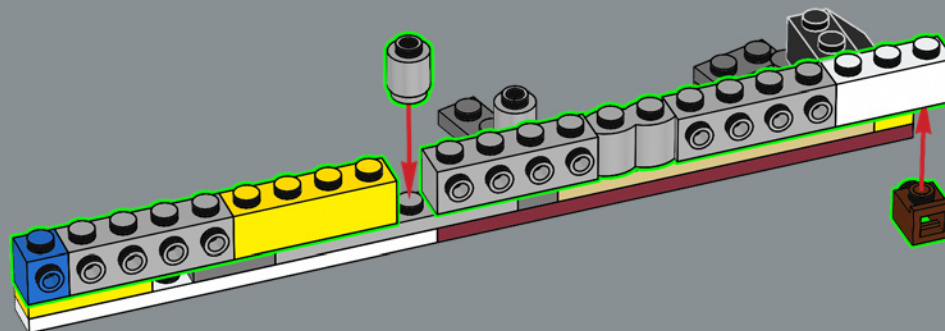

39

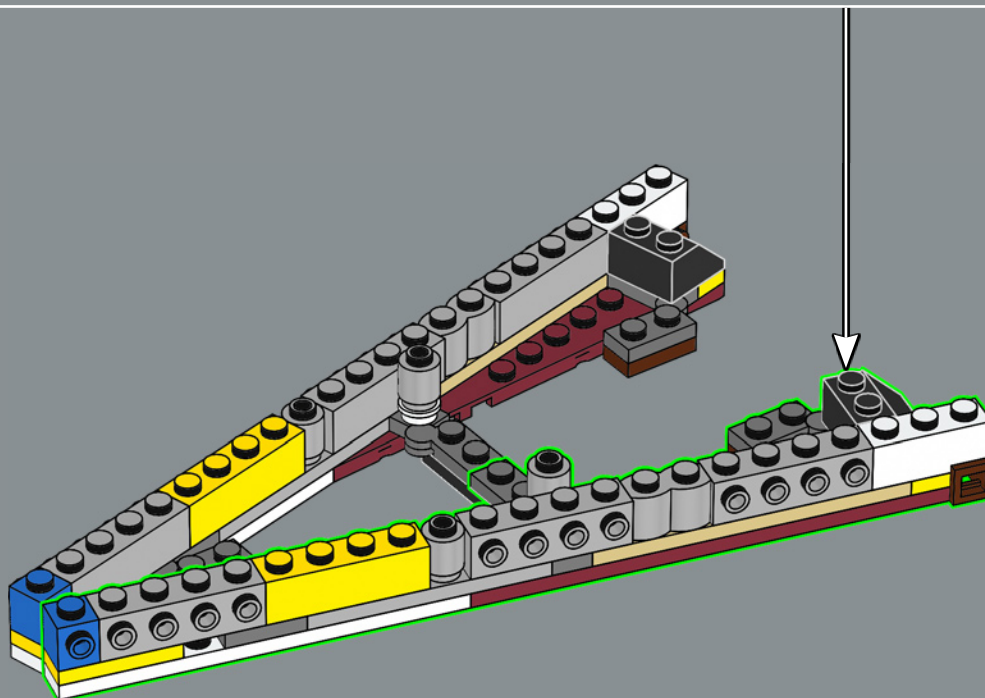

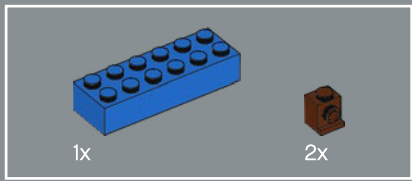

40

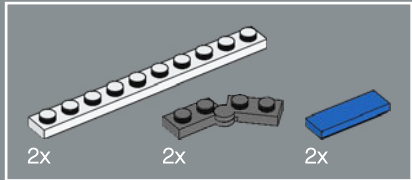
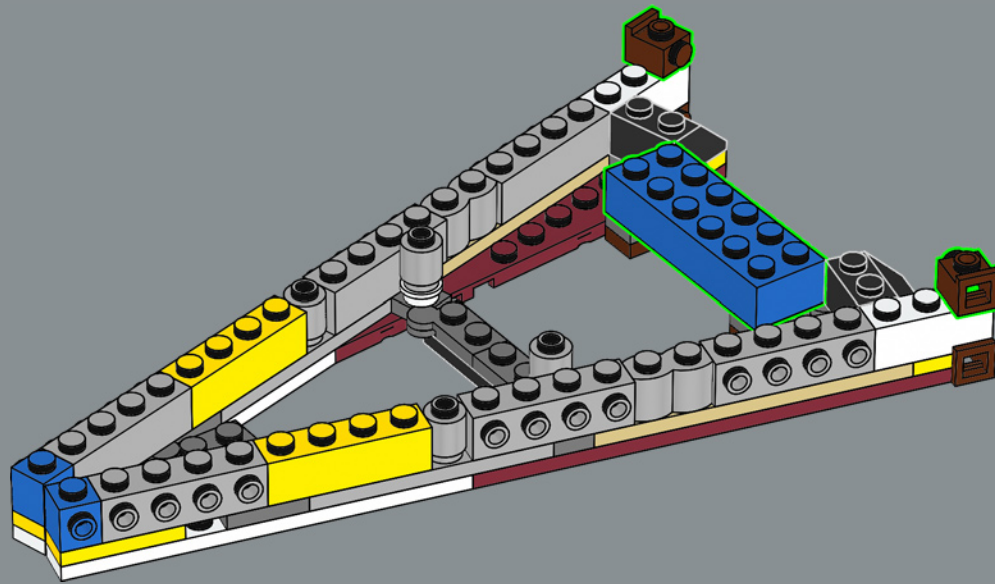

41

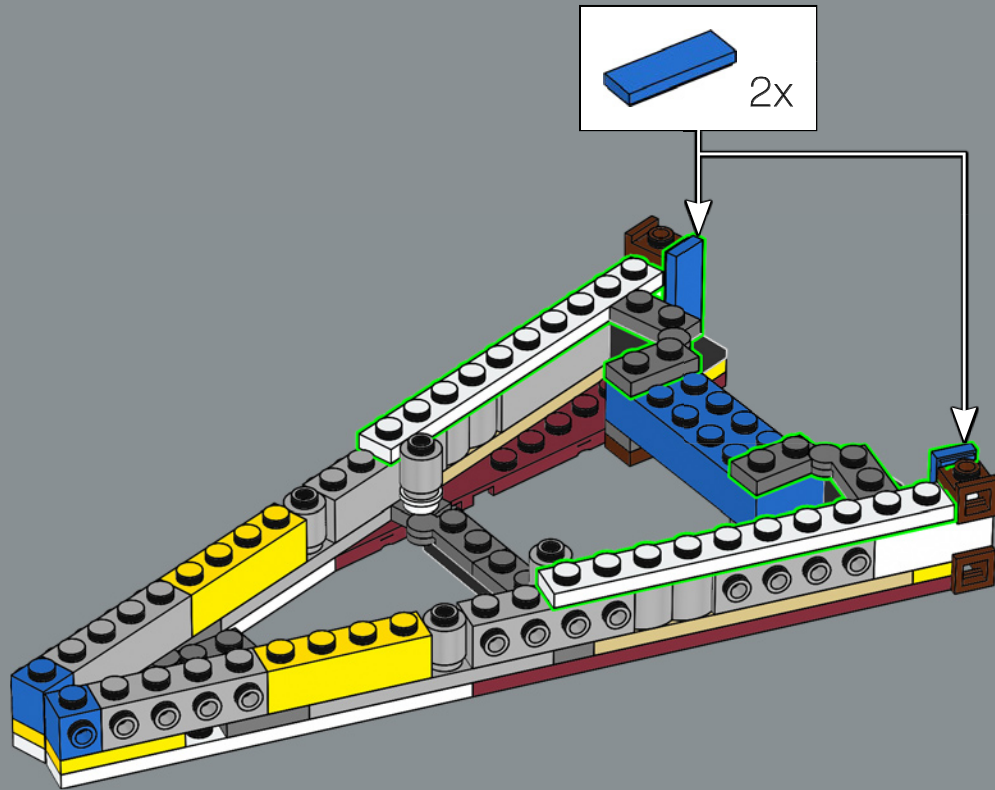

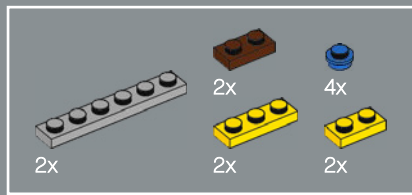

42

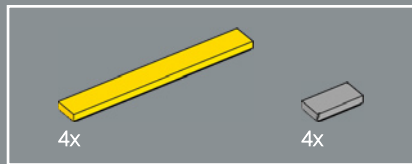
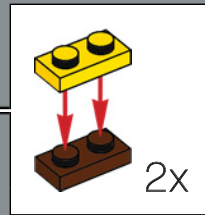
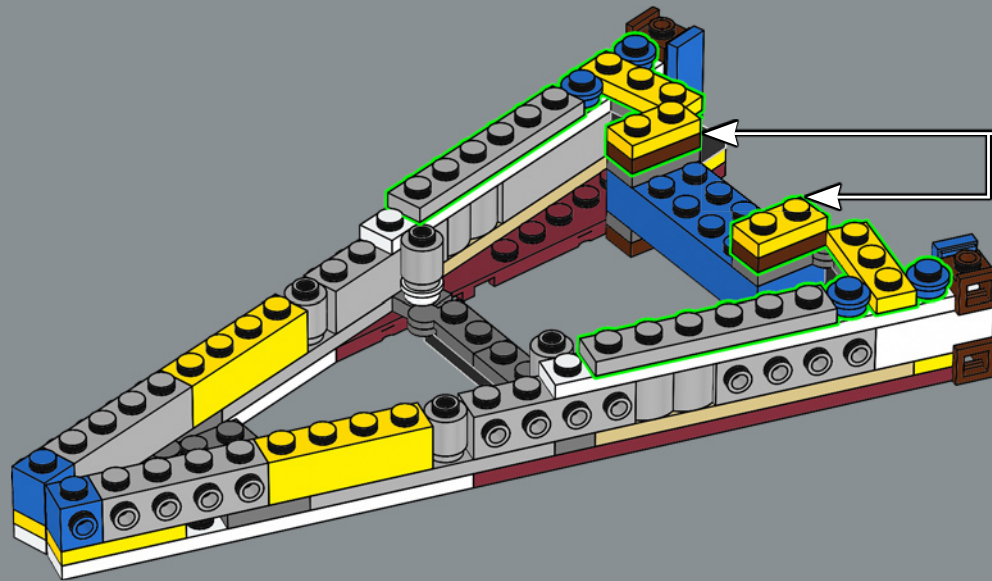

43

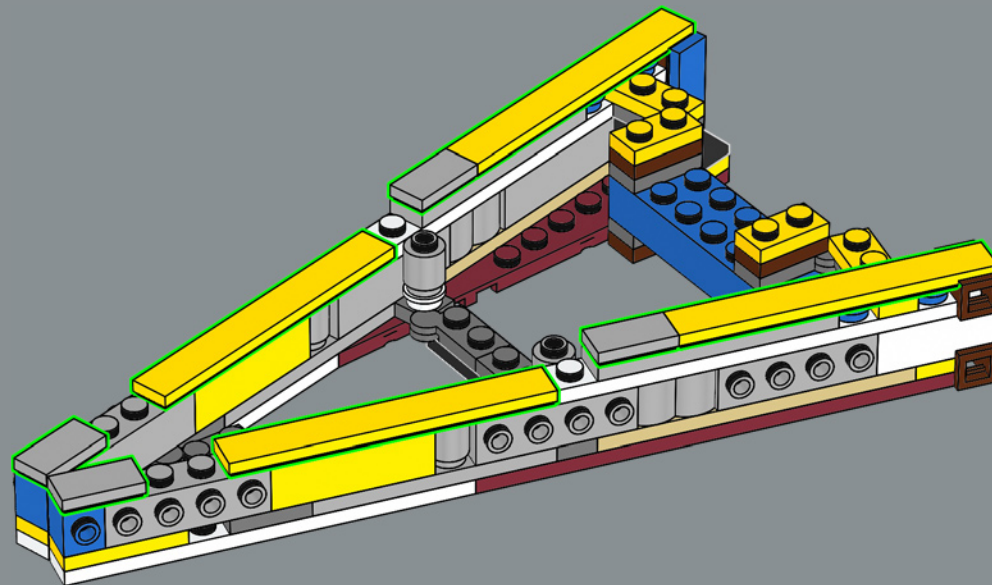

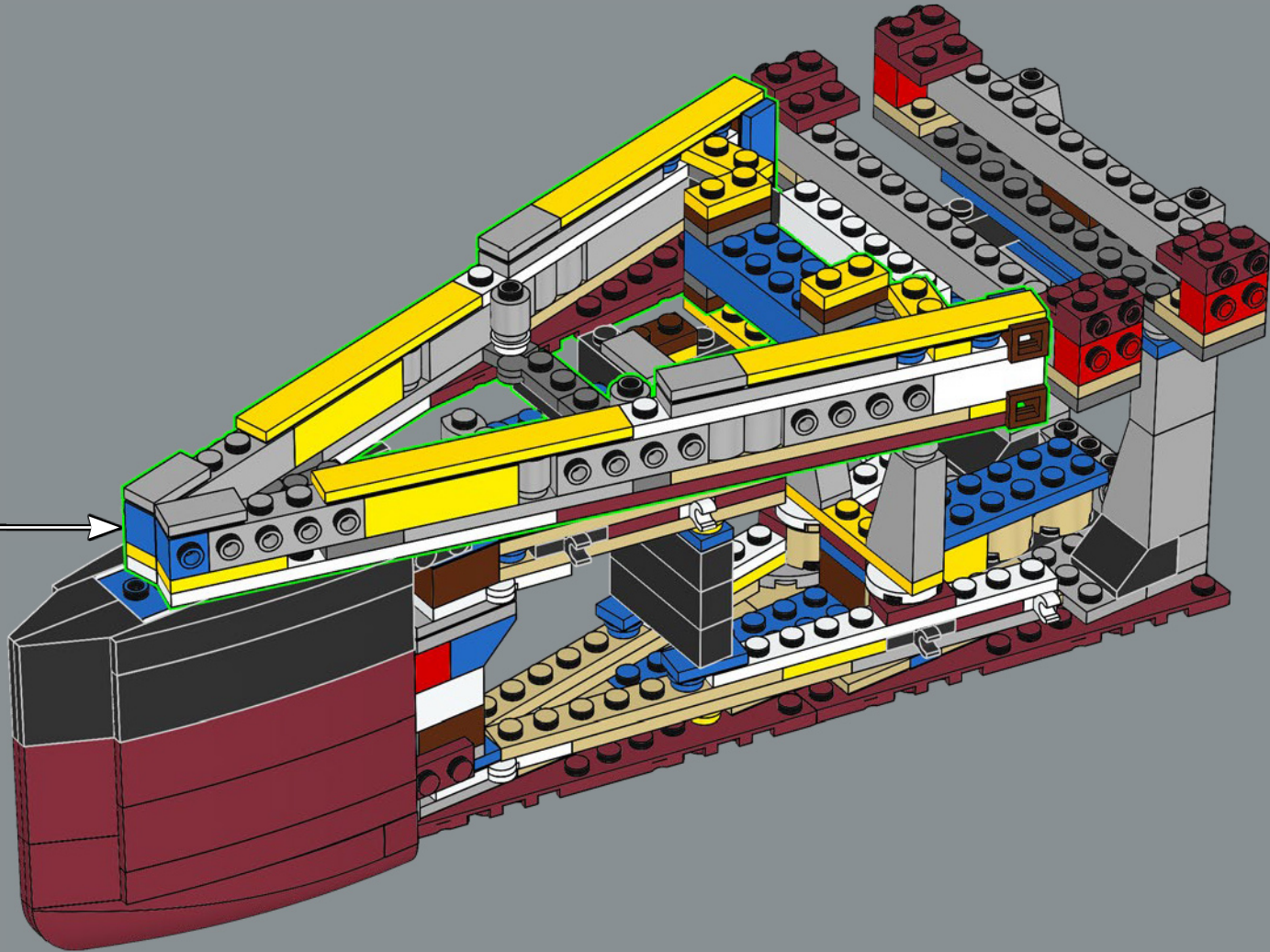

La construcción del *Olympic* y el *Titanic* se desarrolló prácticamente en paralelo. Ambos buques tardaron en construirse 26 meses.

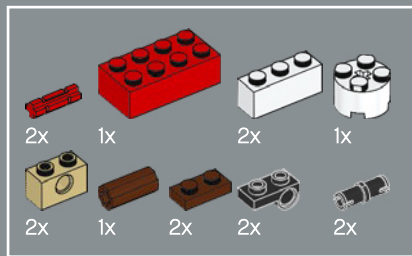

45

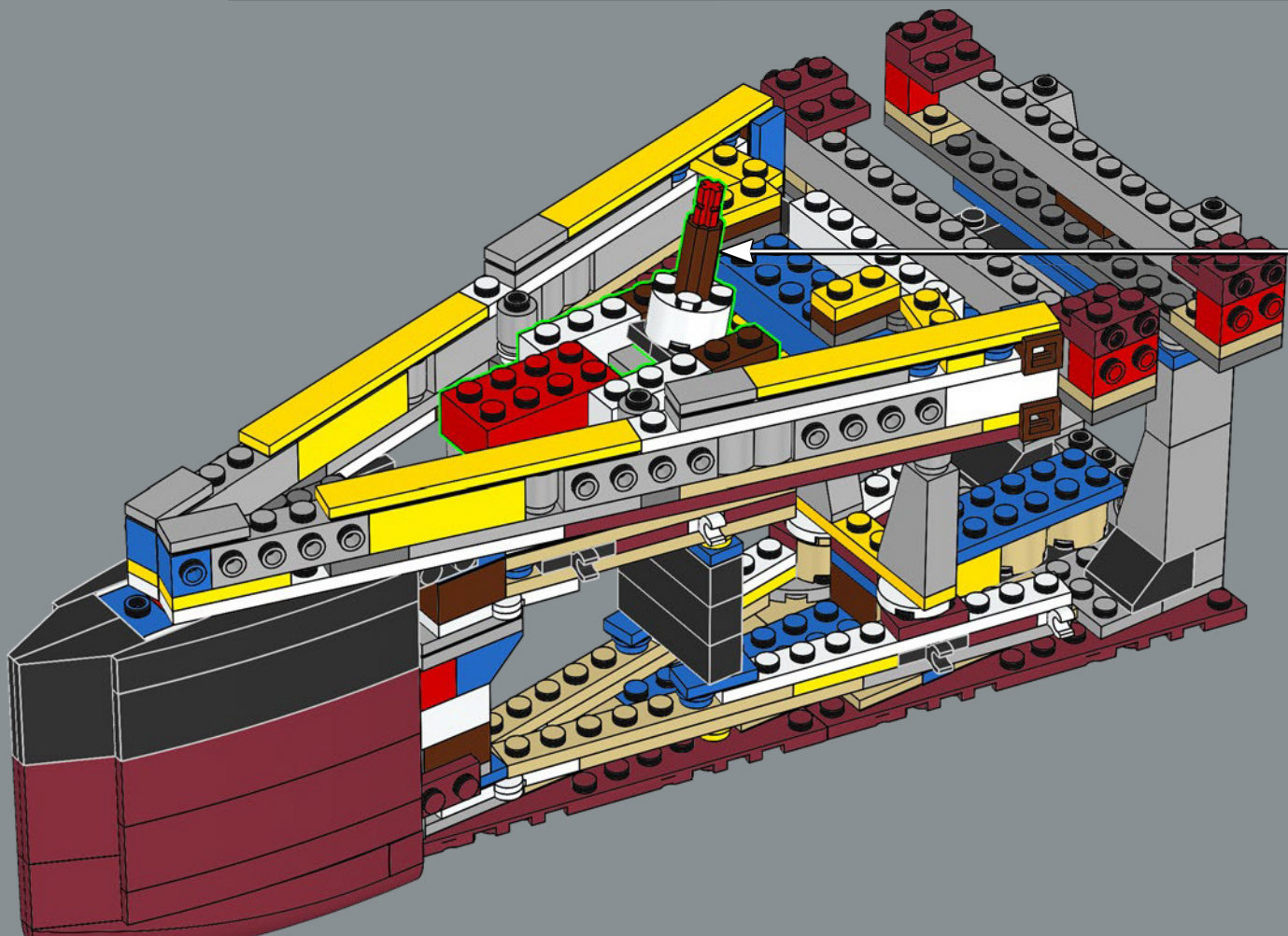
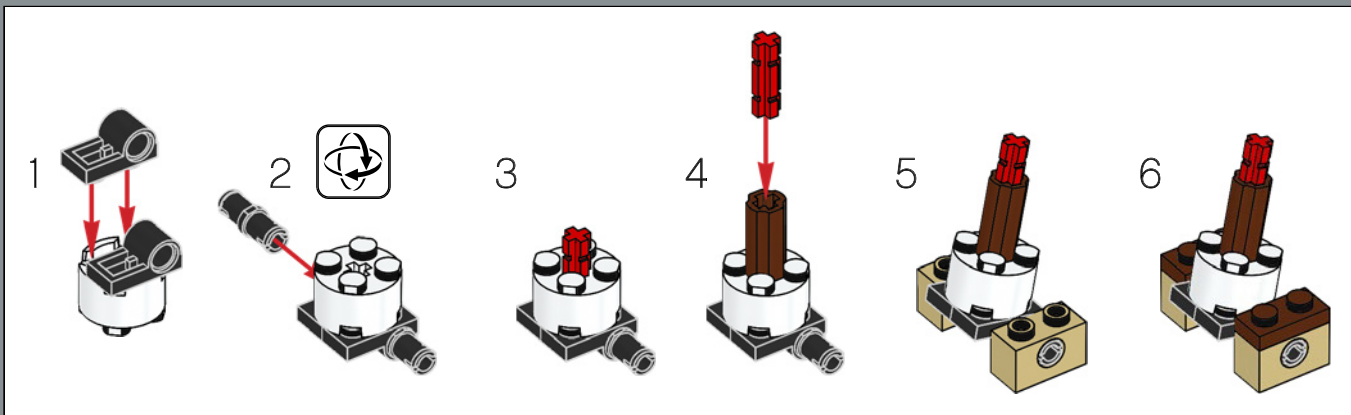

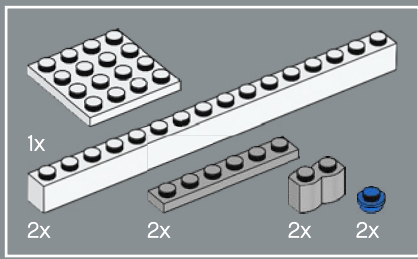

46

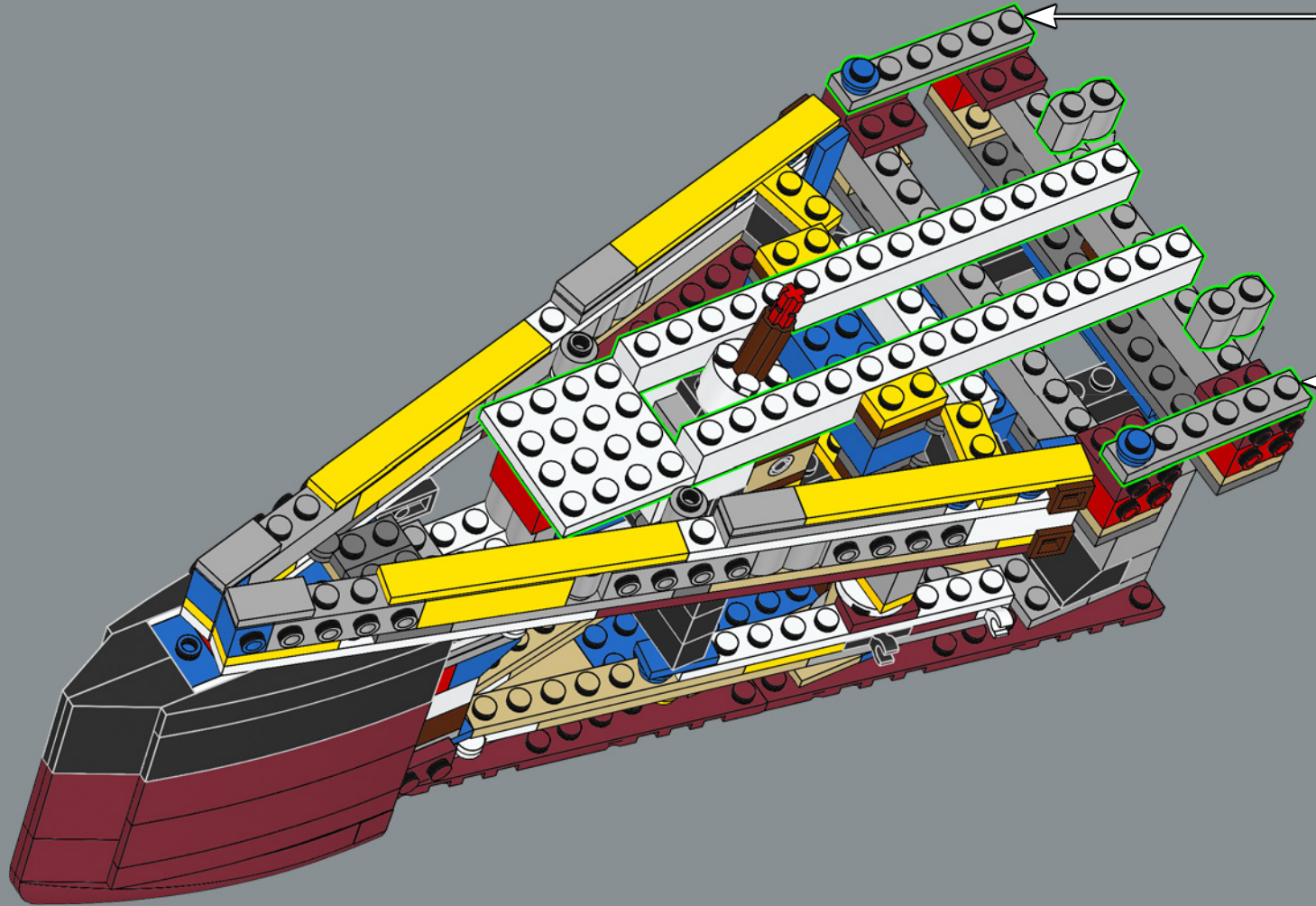
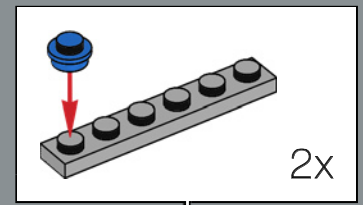

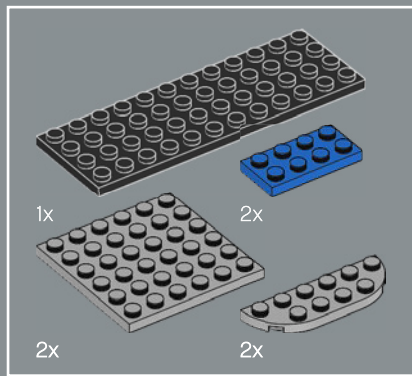

47

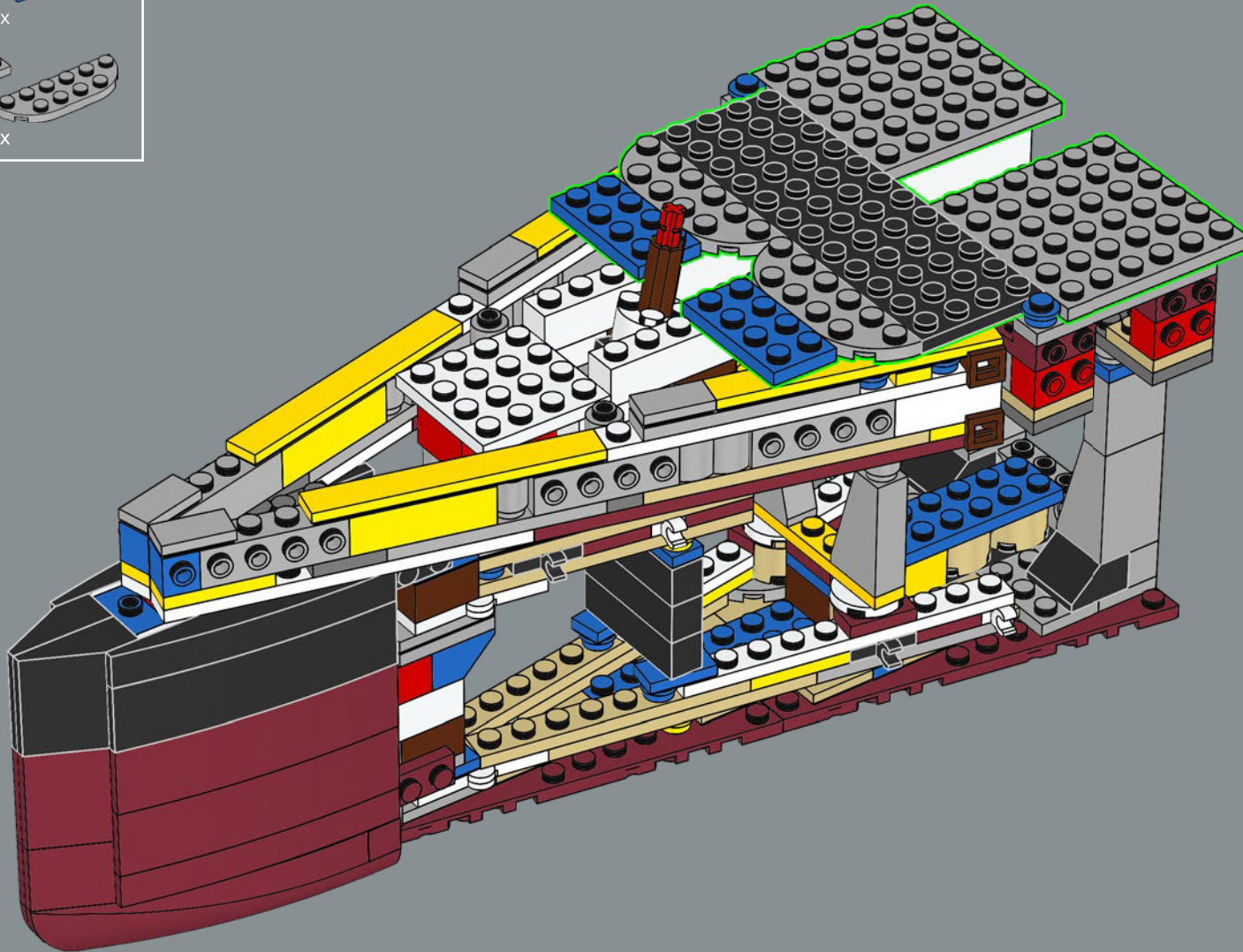

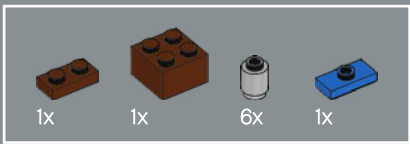

48

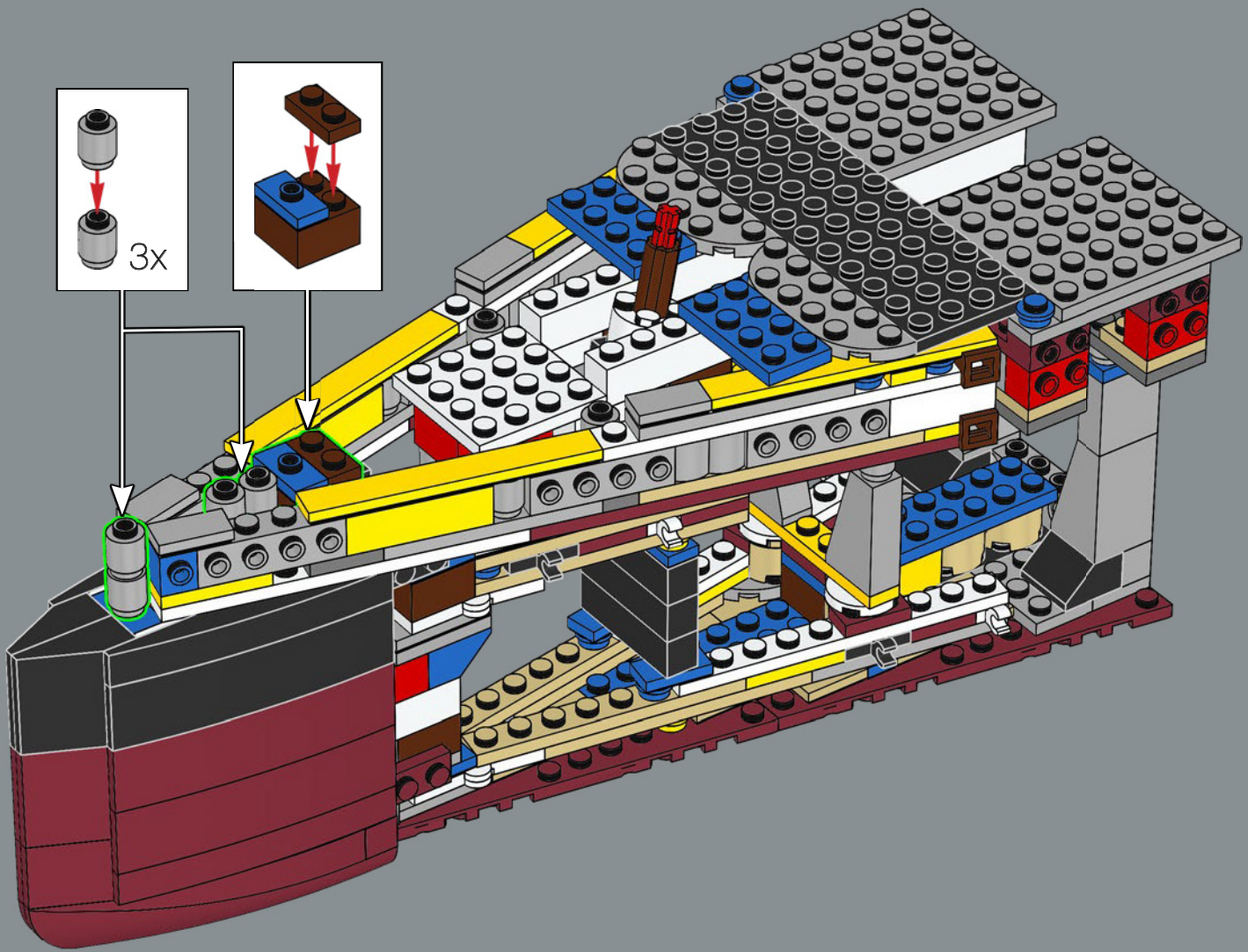

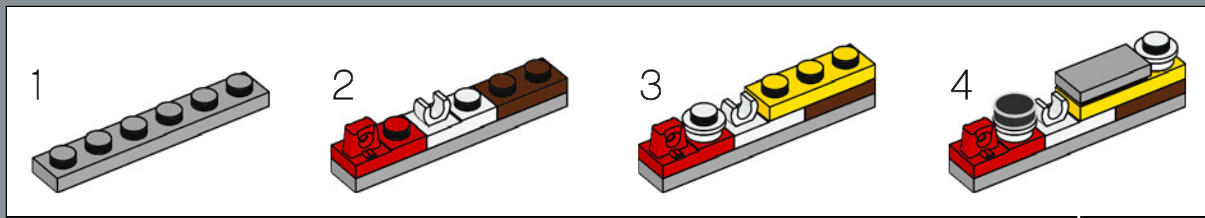
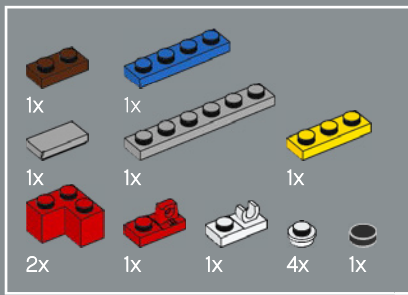

49

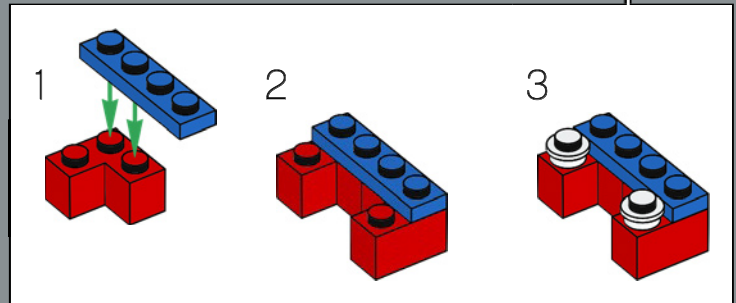
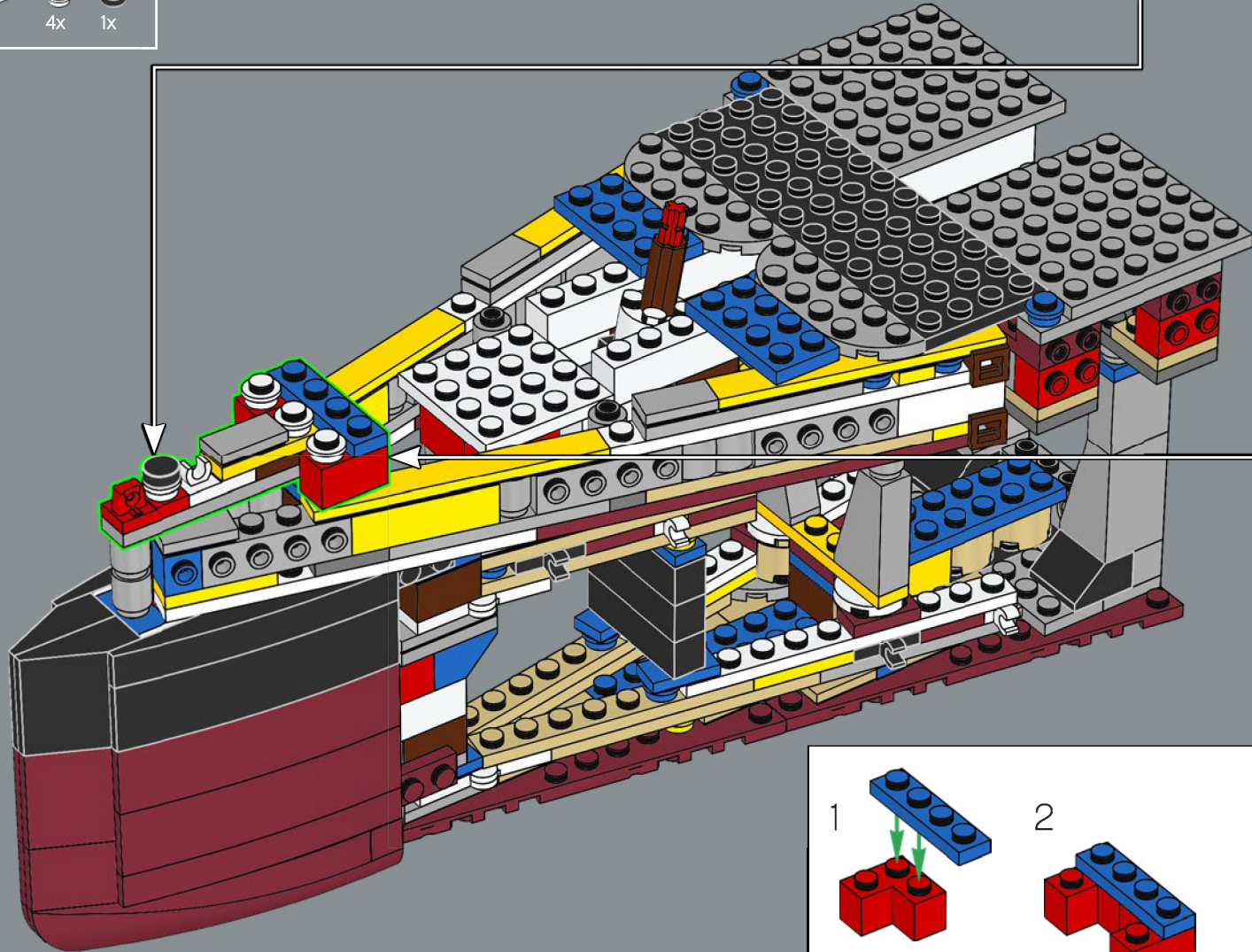

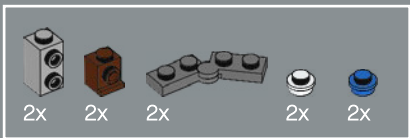

50

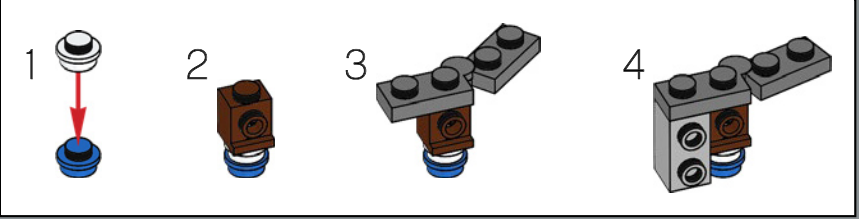
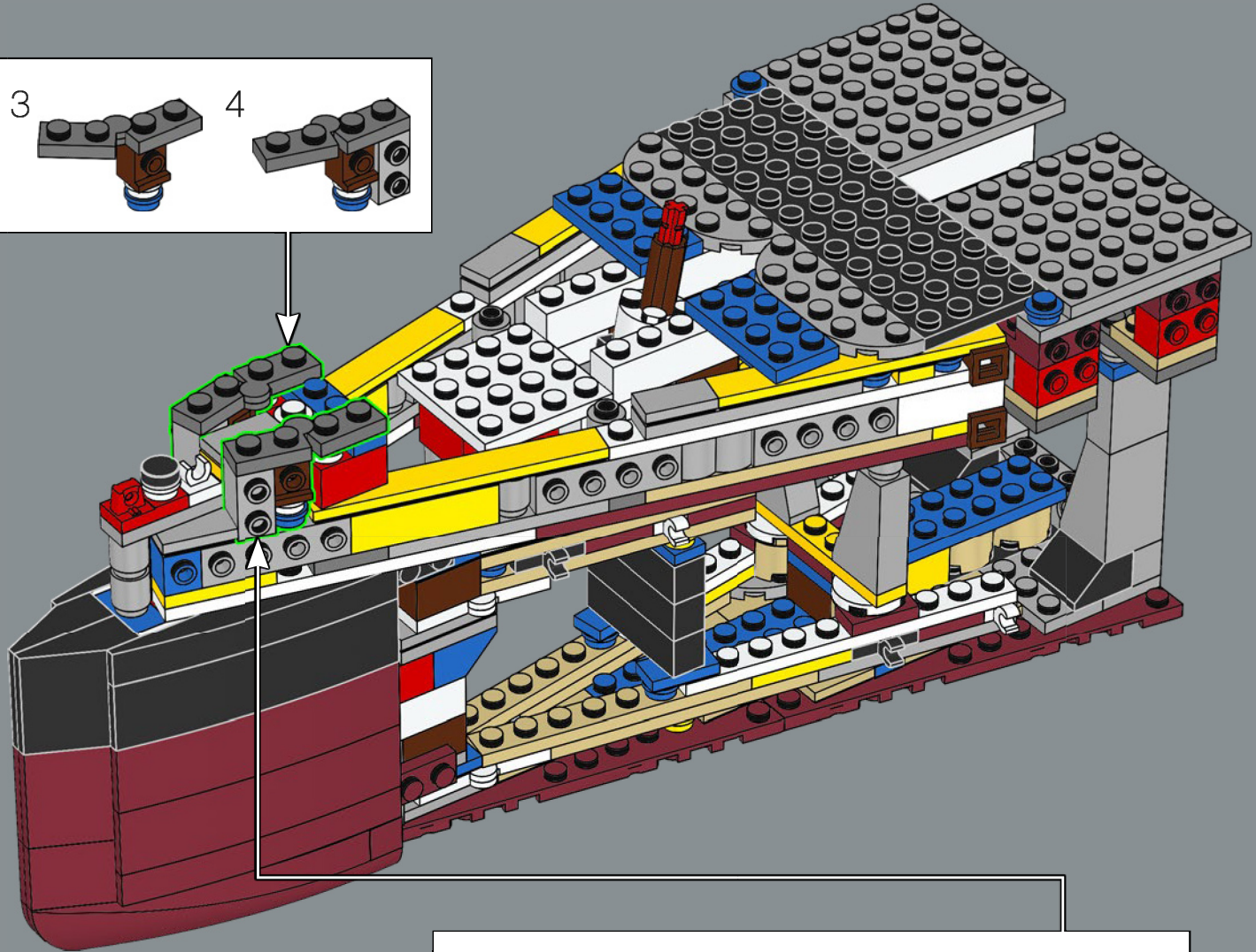
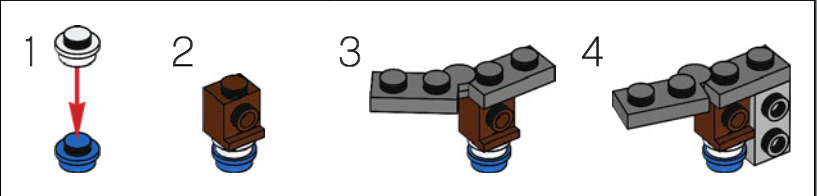

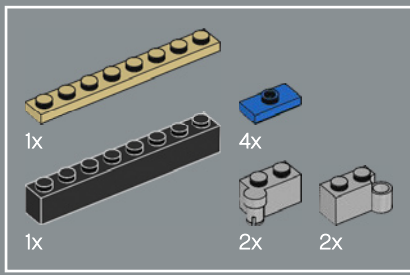

51

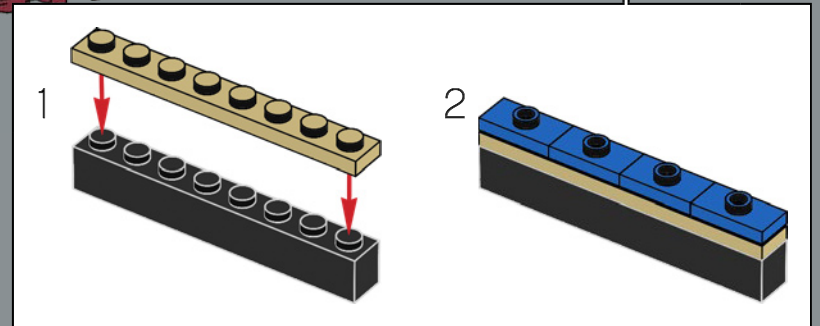
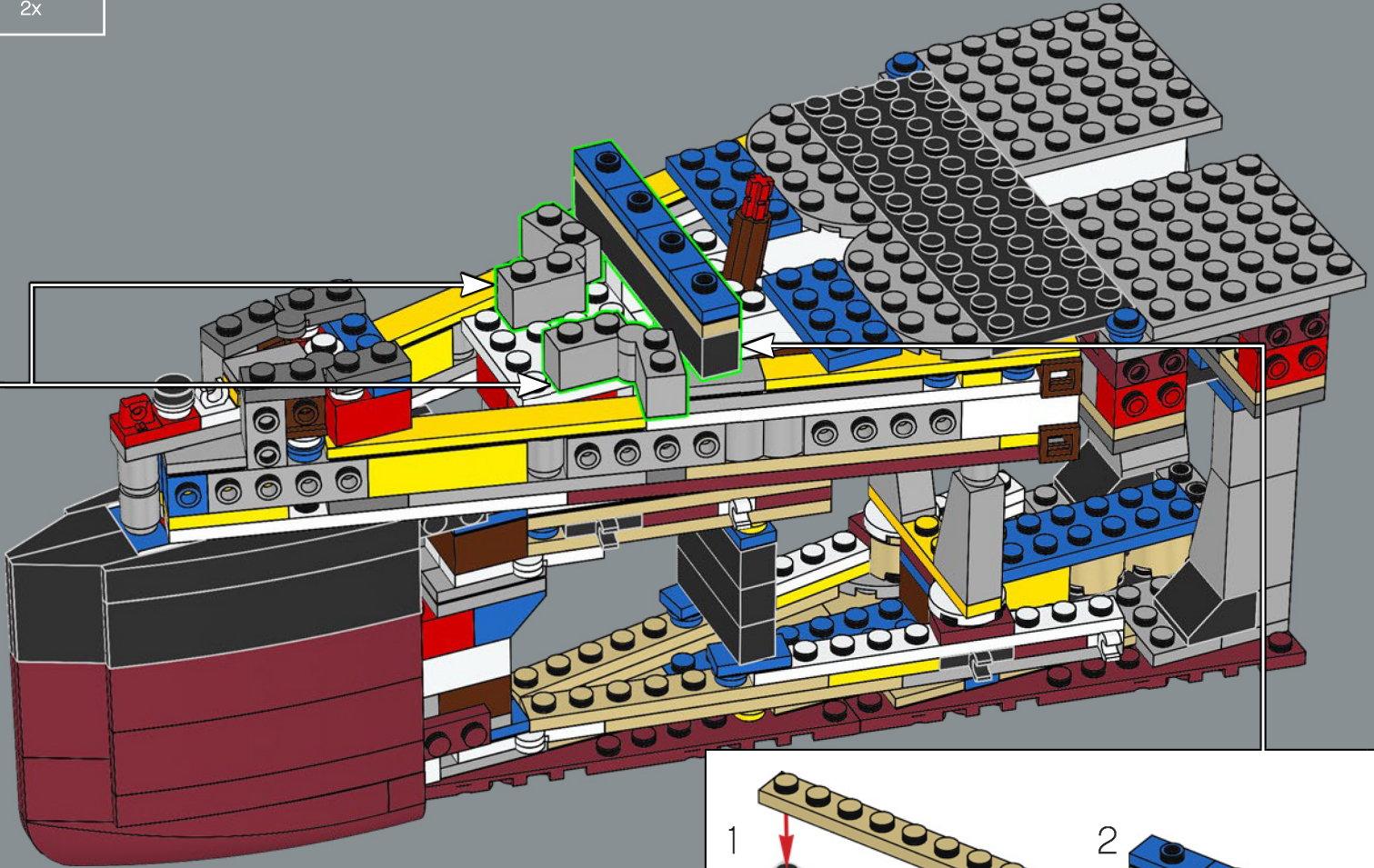
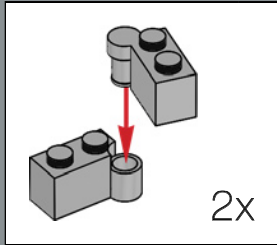

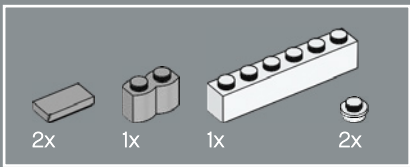

52

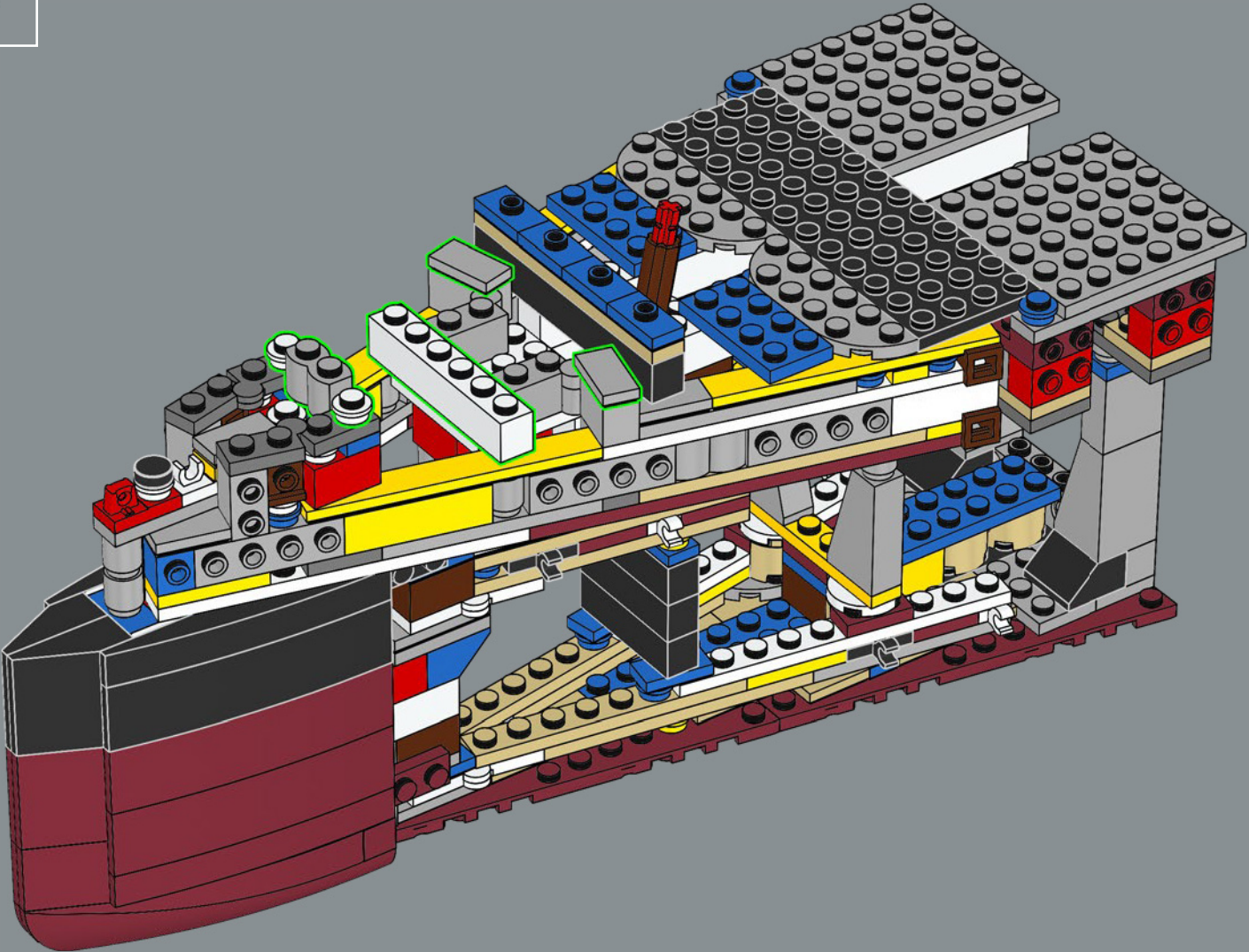

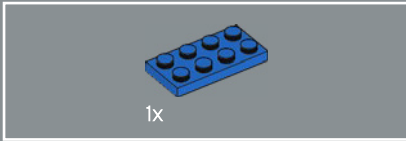
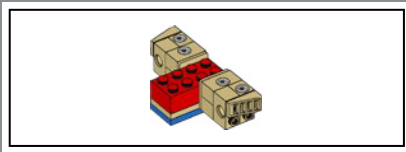

1x

53

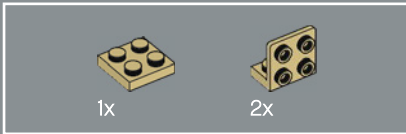
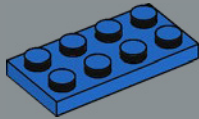

1x

2x

54

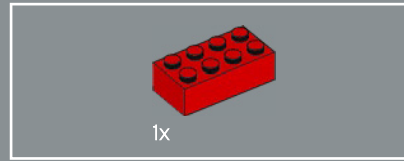
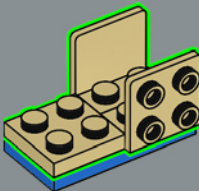

1x

55

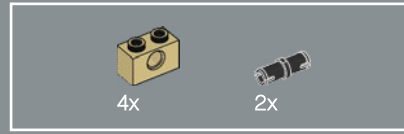
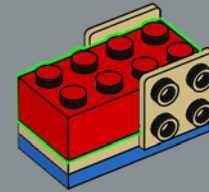

4x

2x

56

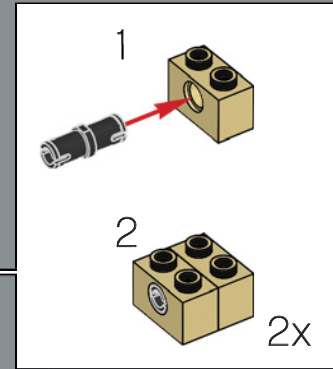

1

2

2x

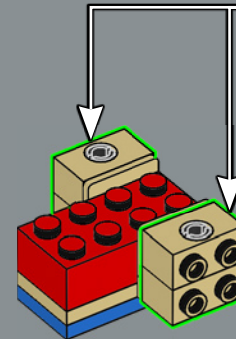

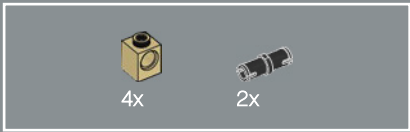

57

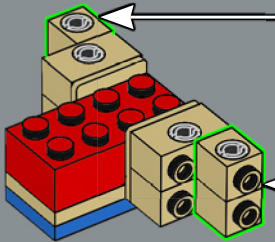
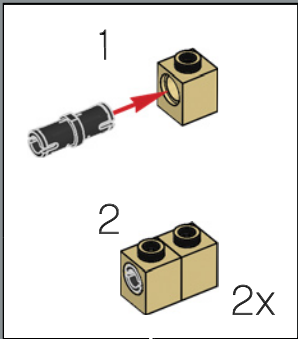

59

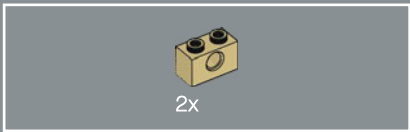
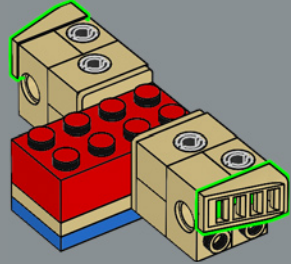

58

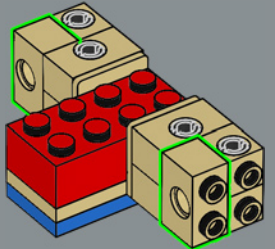

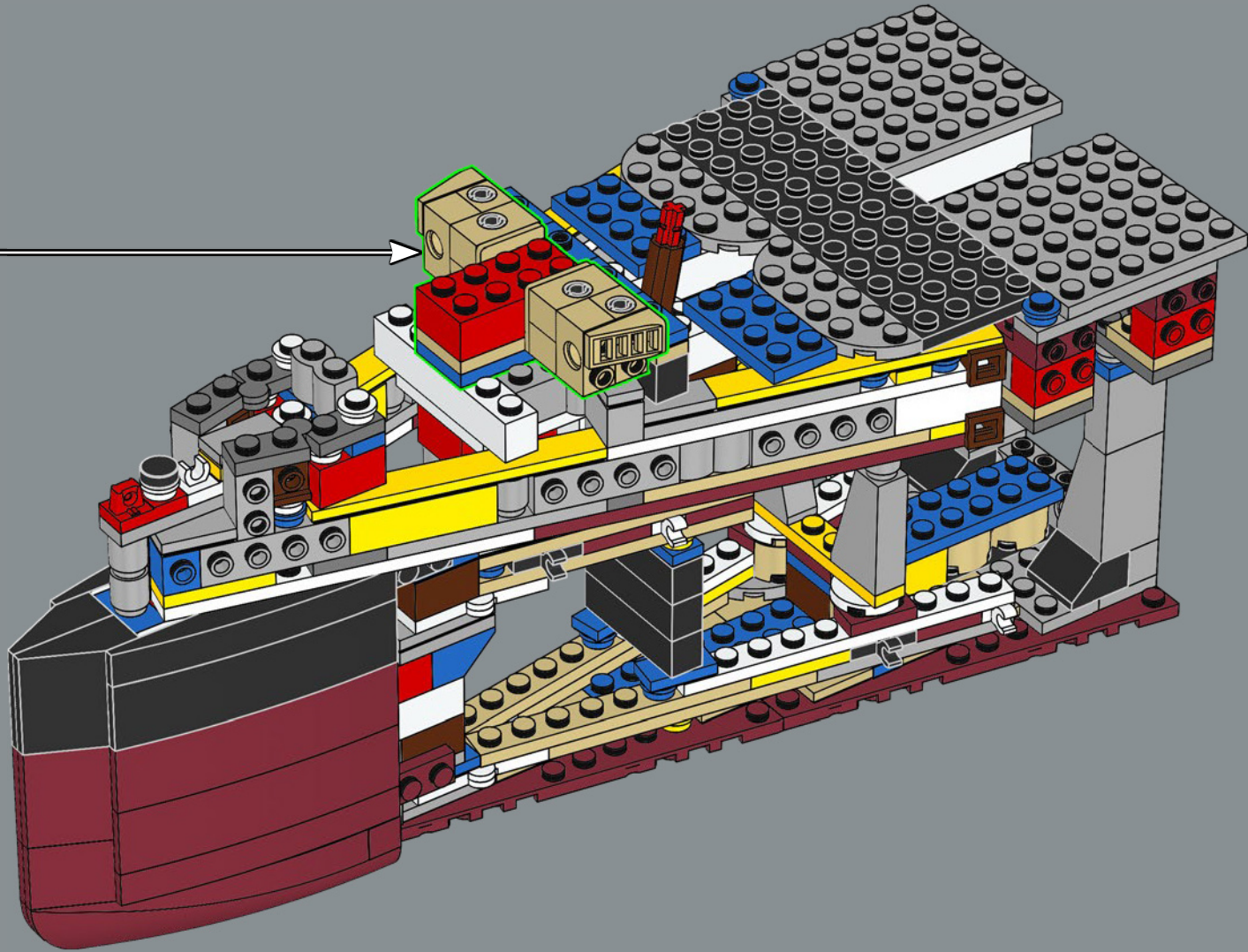

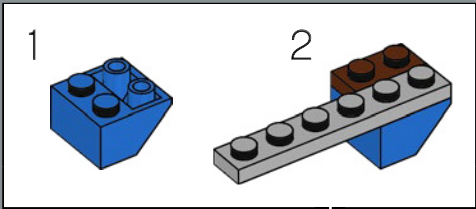
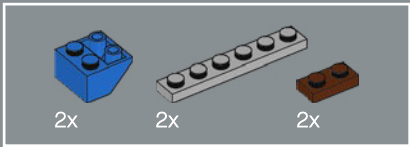

61

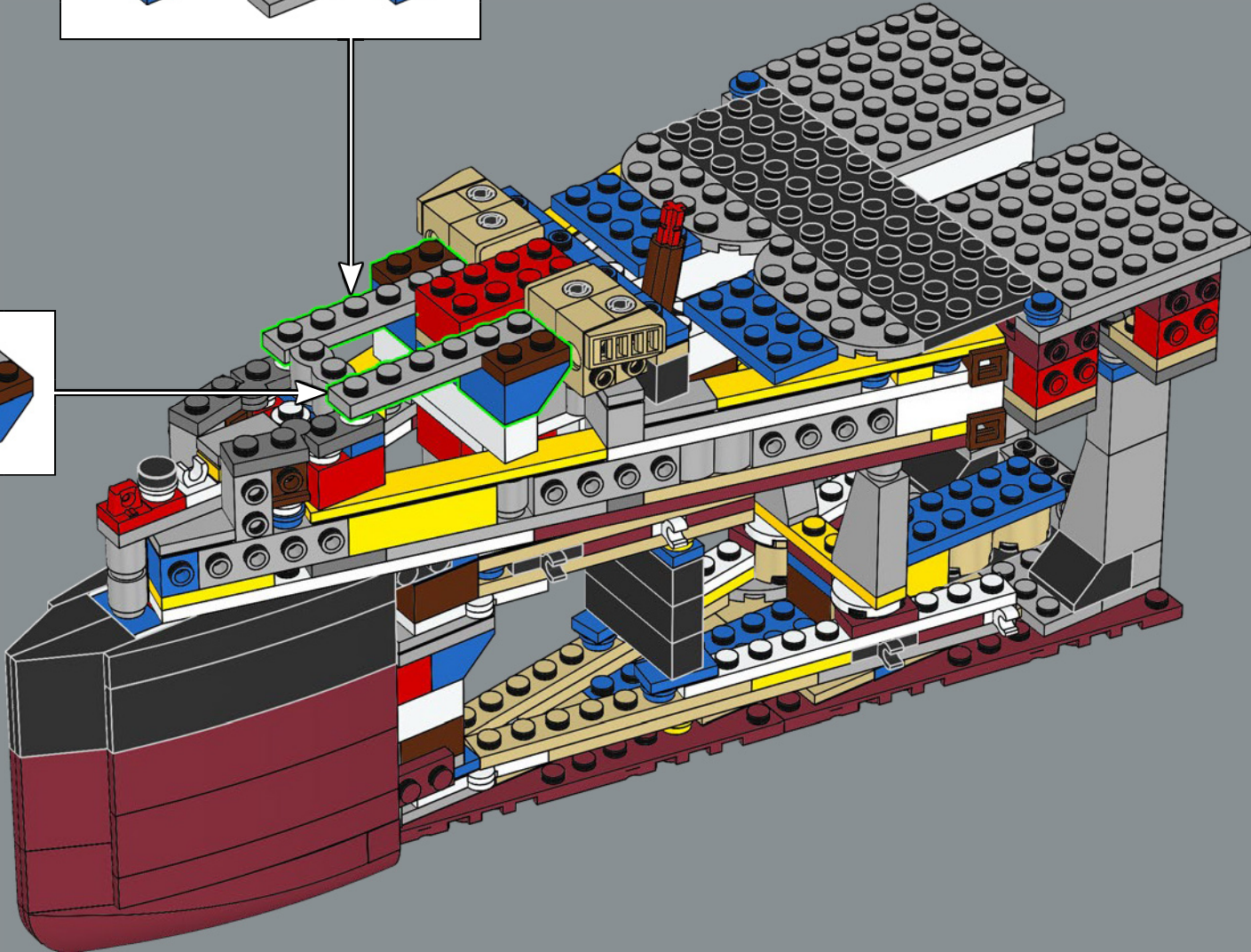
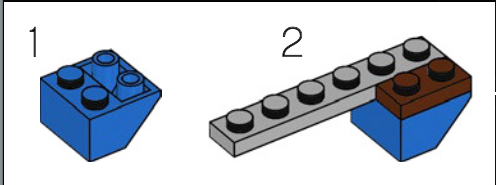

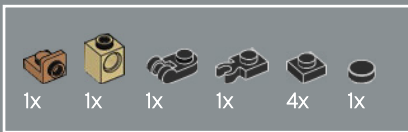

62

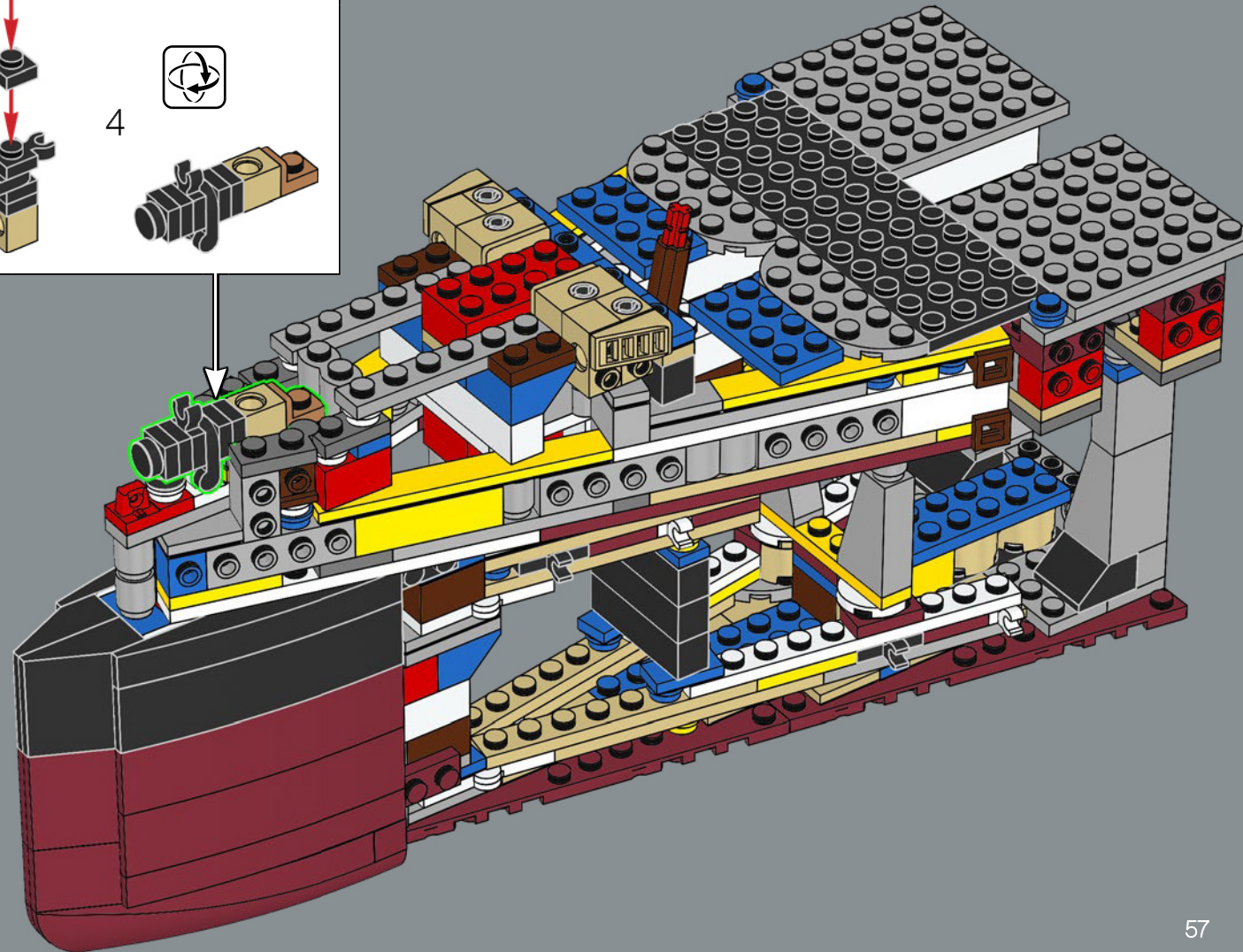
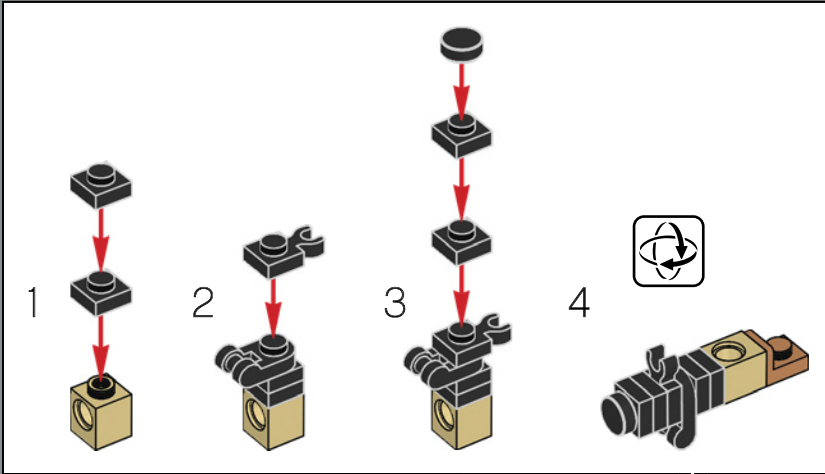

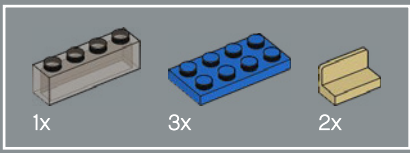

63

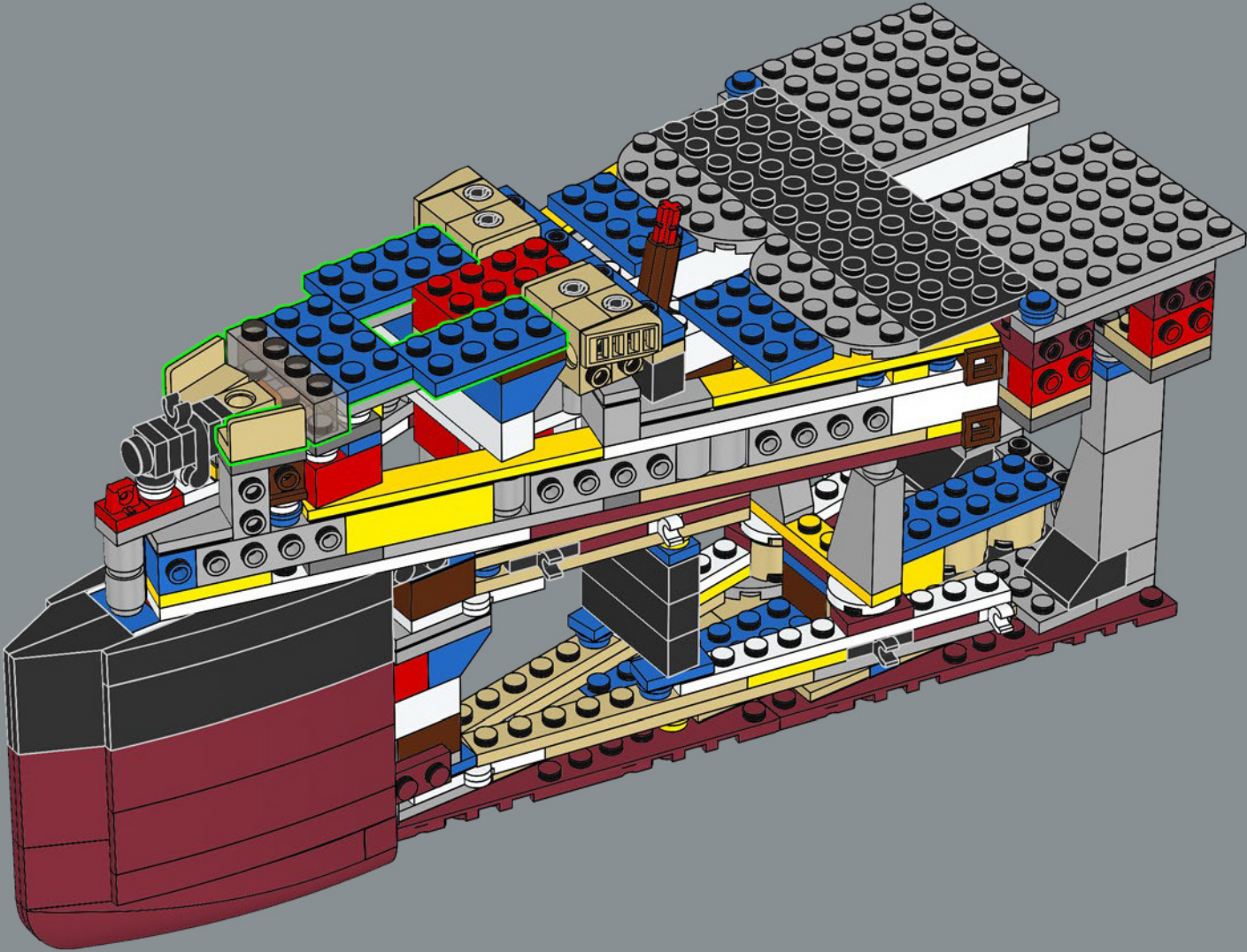

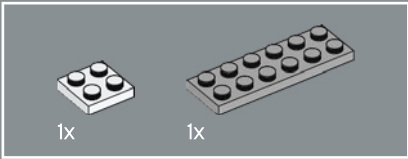
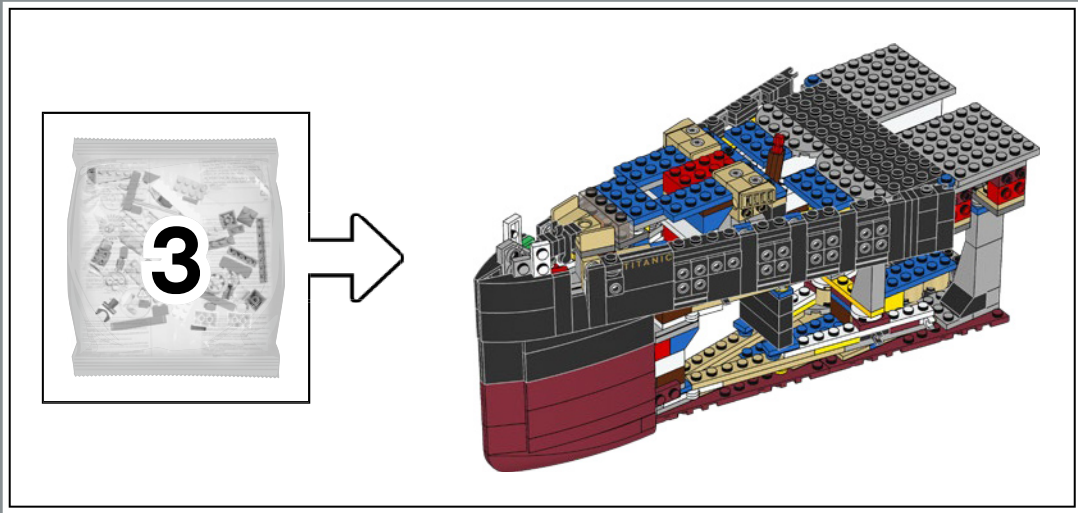

65

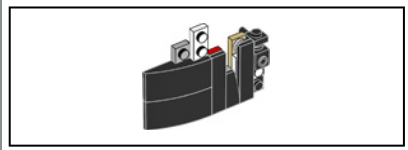

64

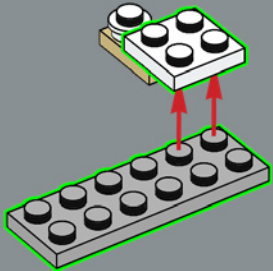
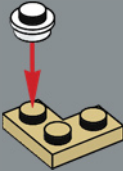

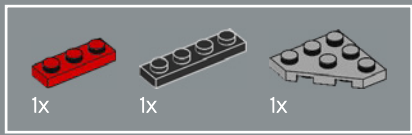

66

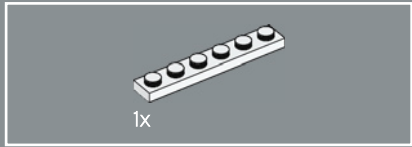
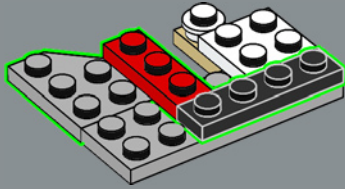

67

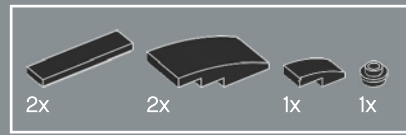
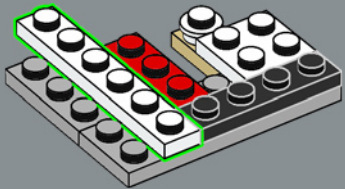

68

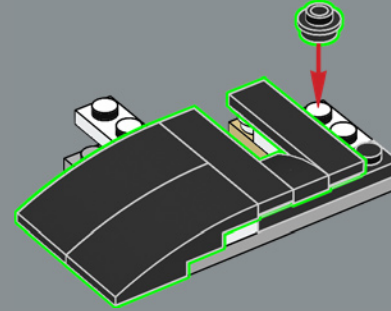

69

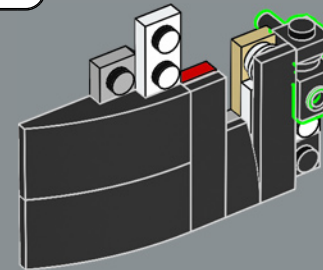
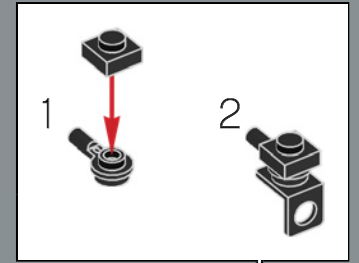

70

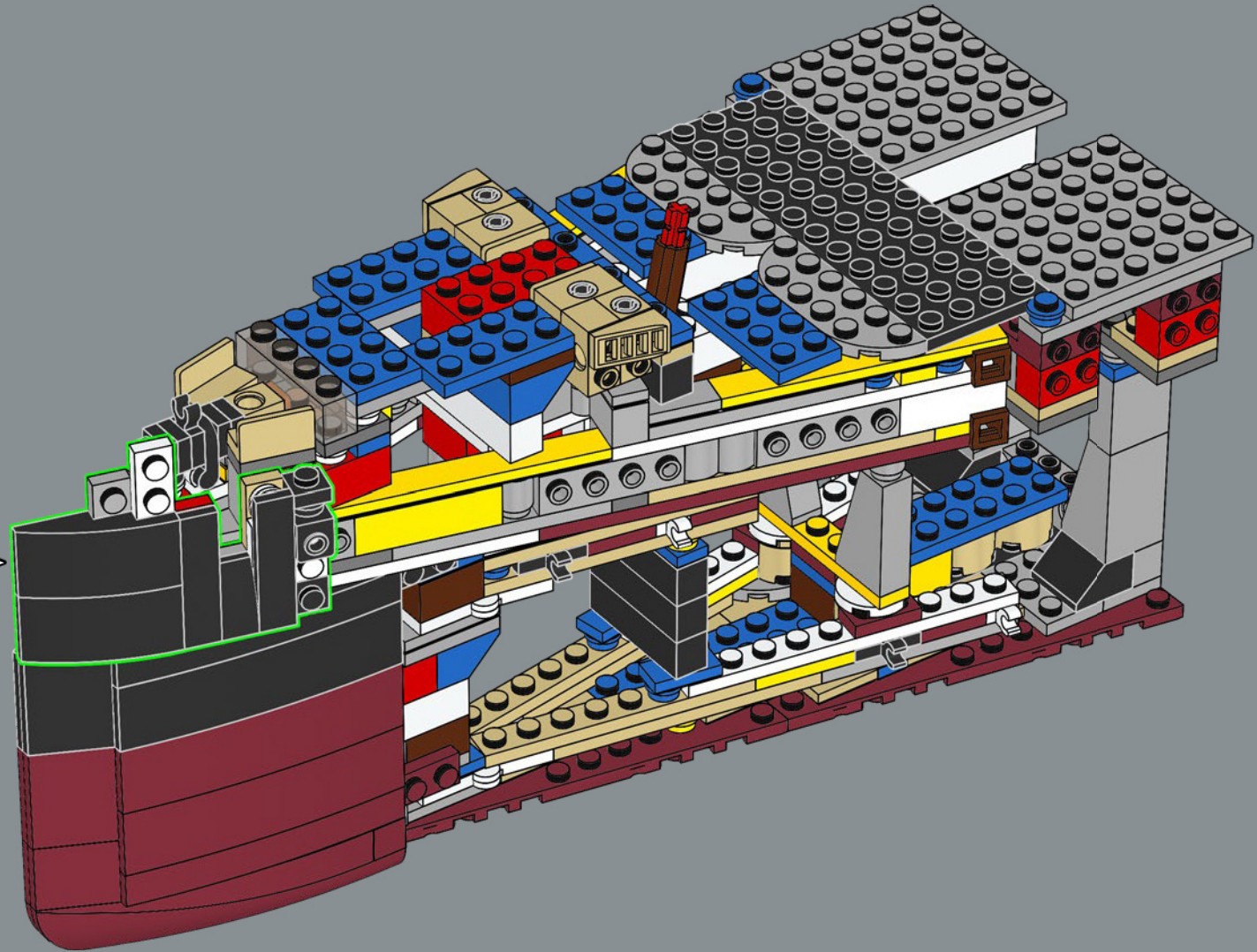

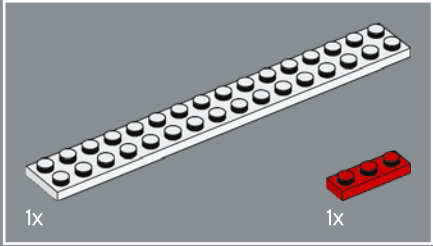
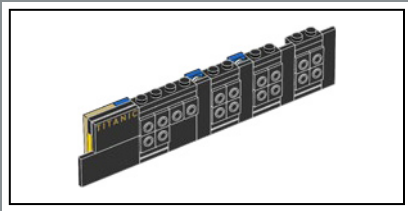

71

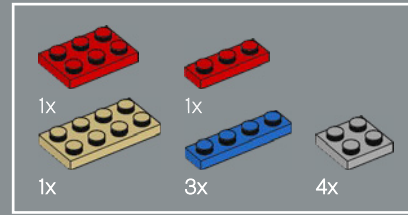
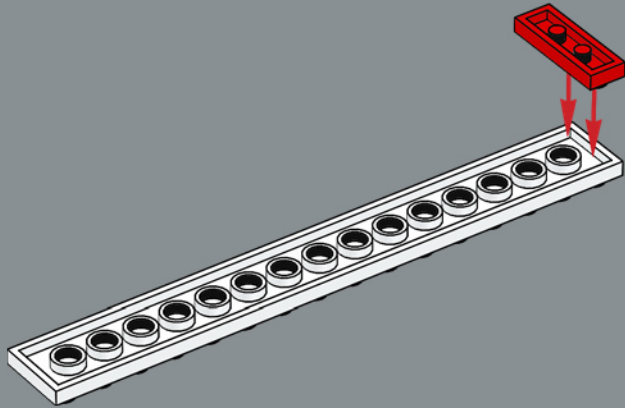

72

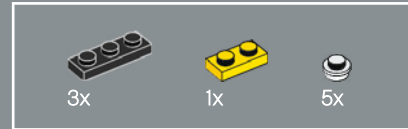
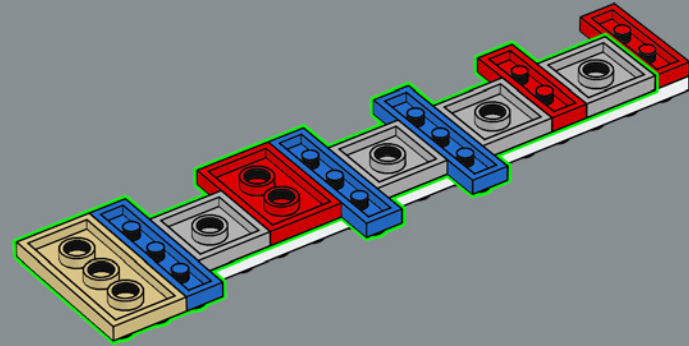

73

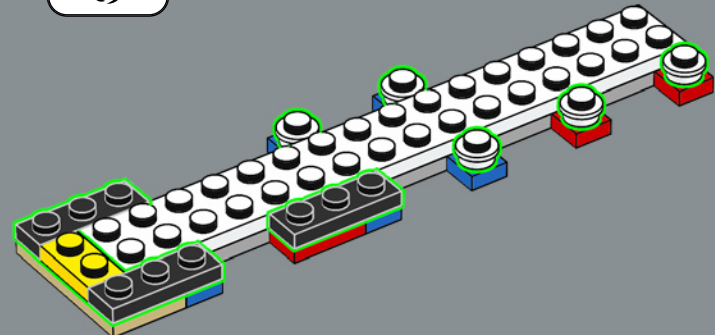

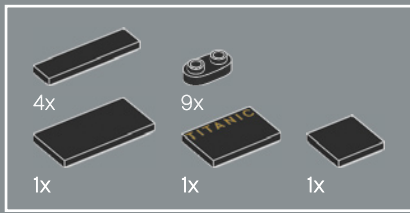

74

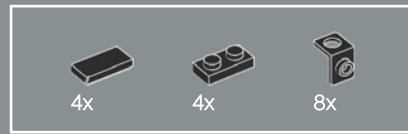
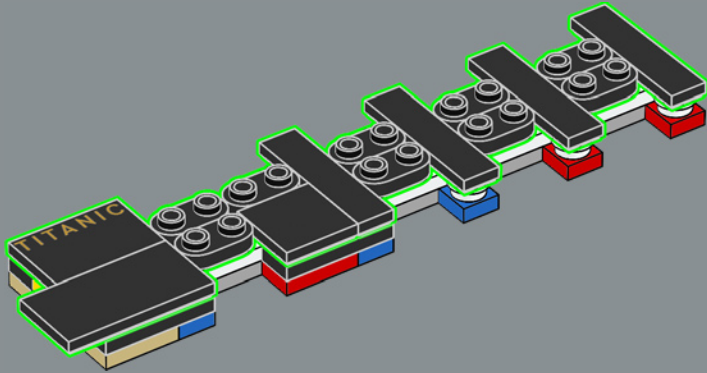

75

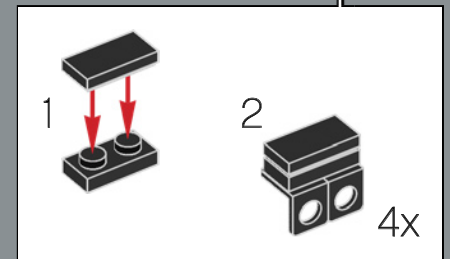
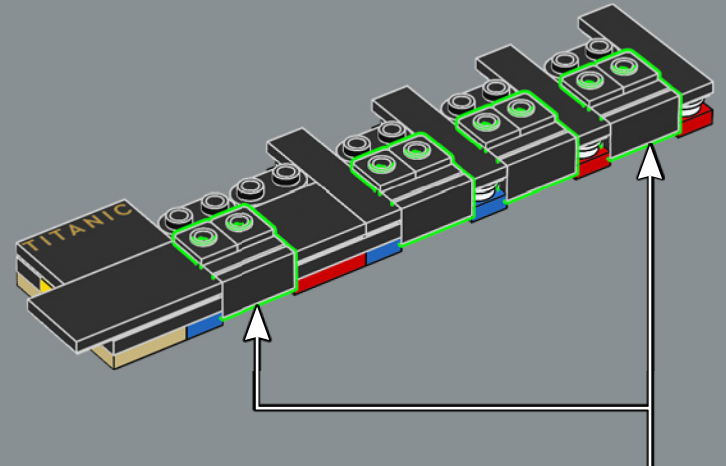

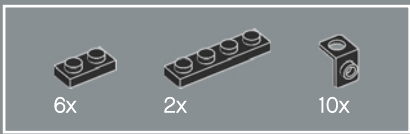

76

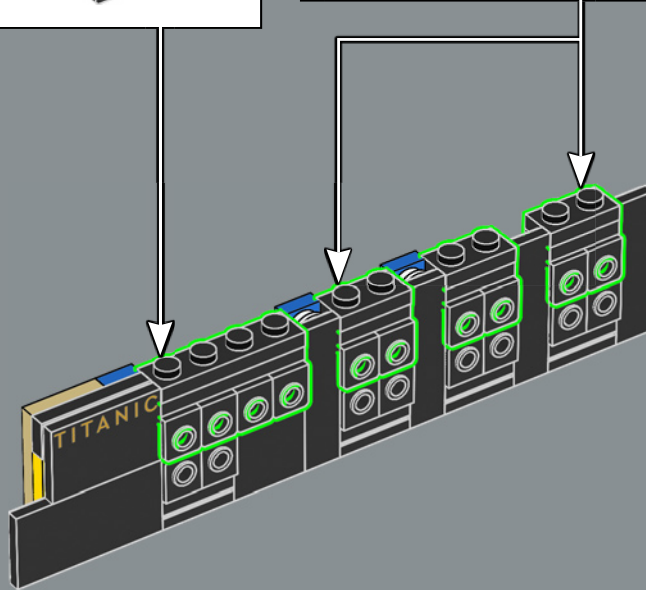
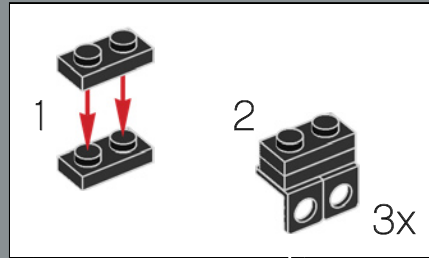
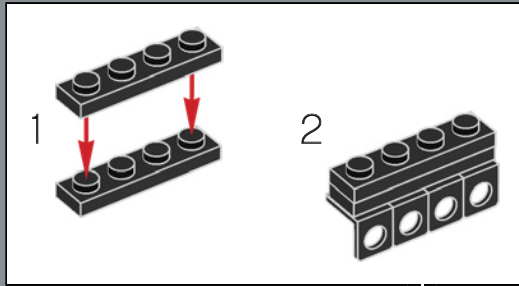

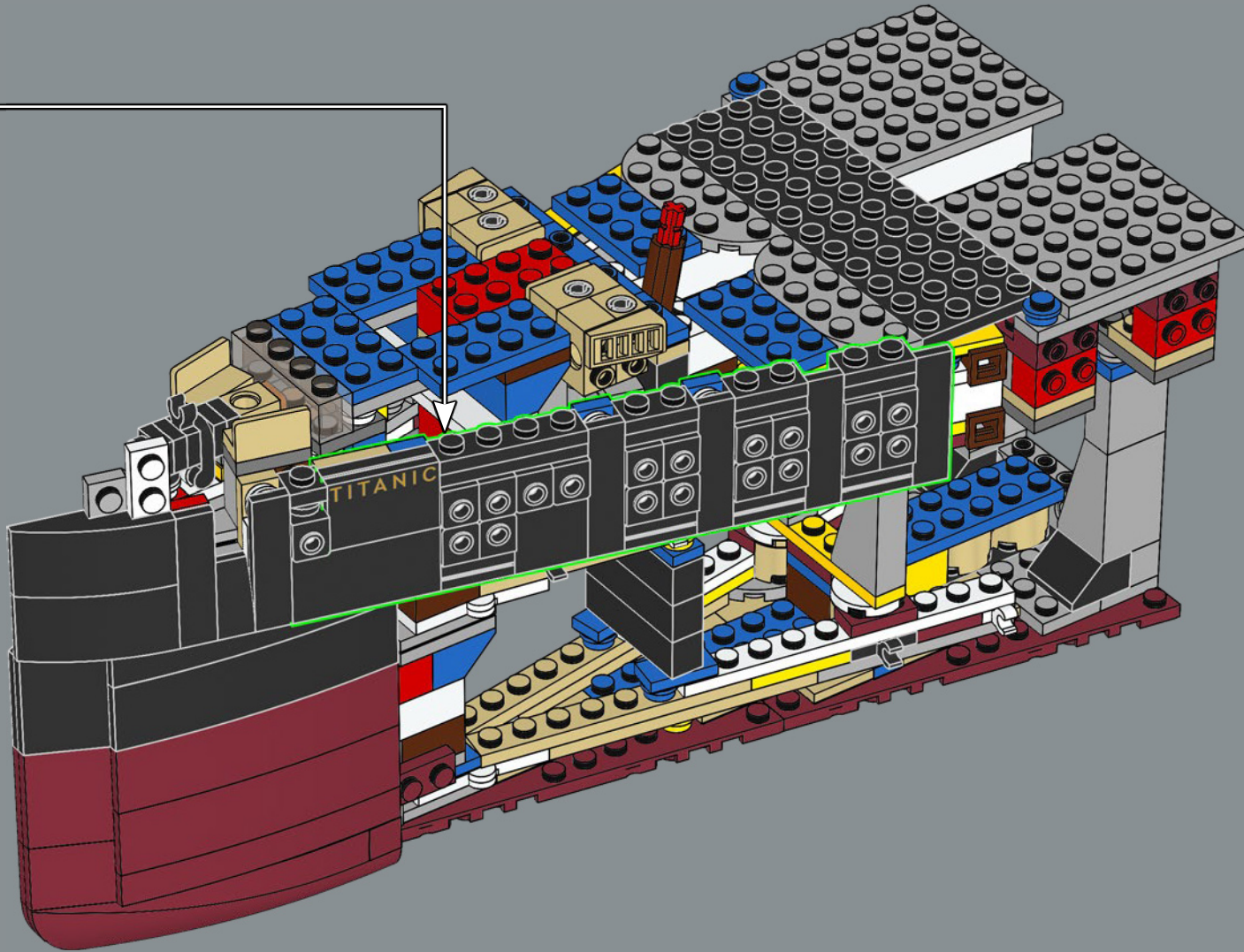

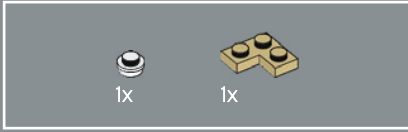
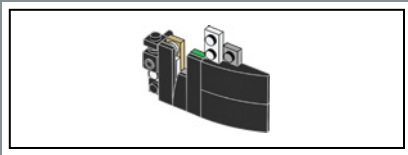

78

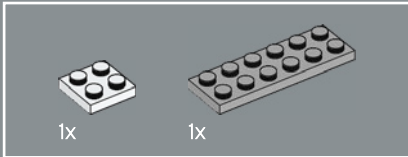
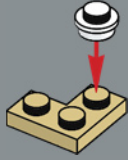

79

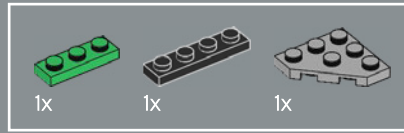
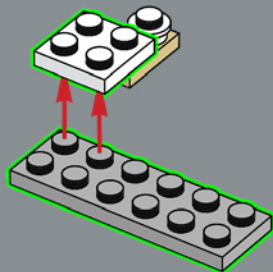

80

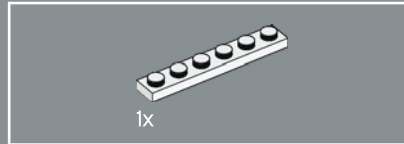
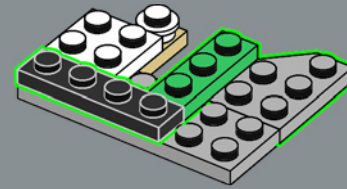

81

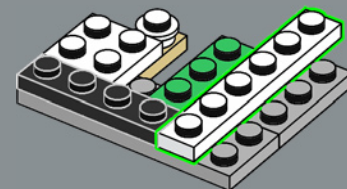



82

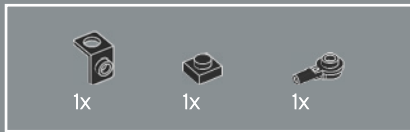
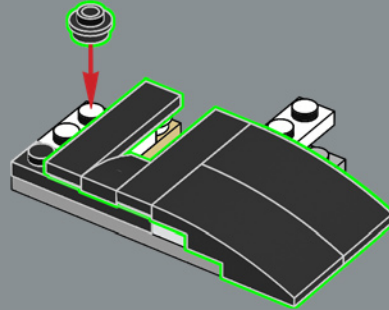

83

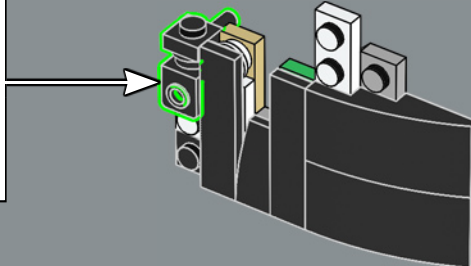
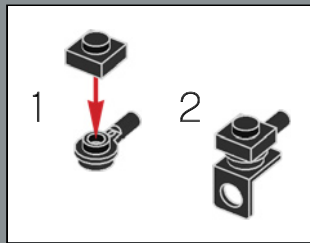

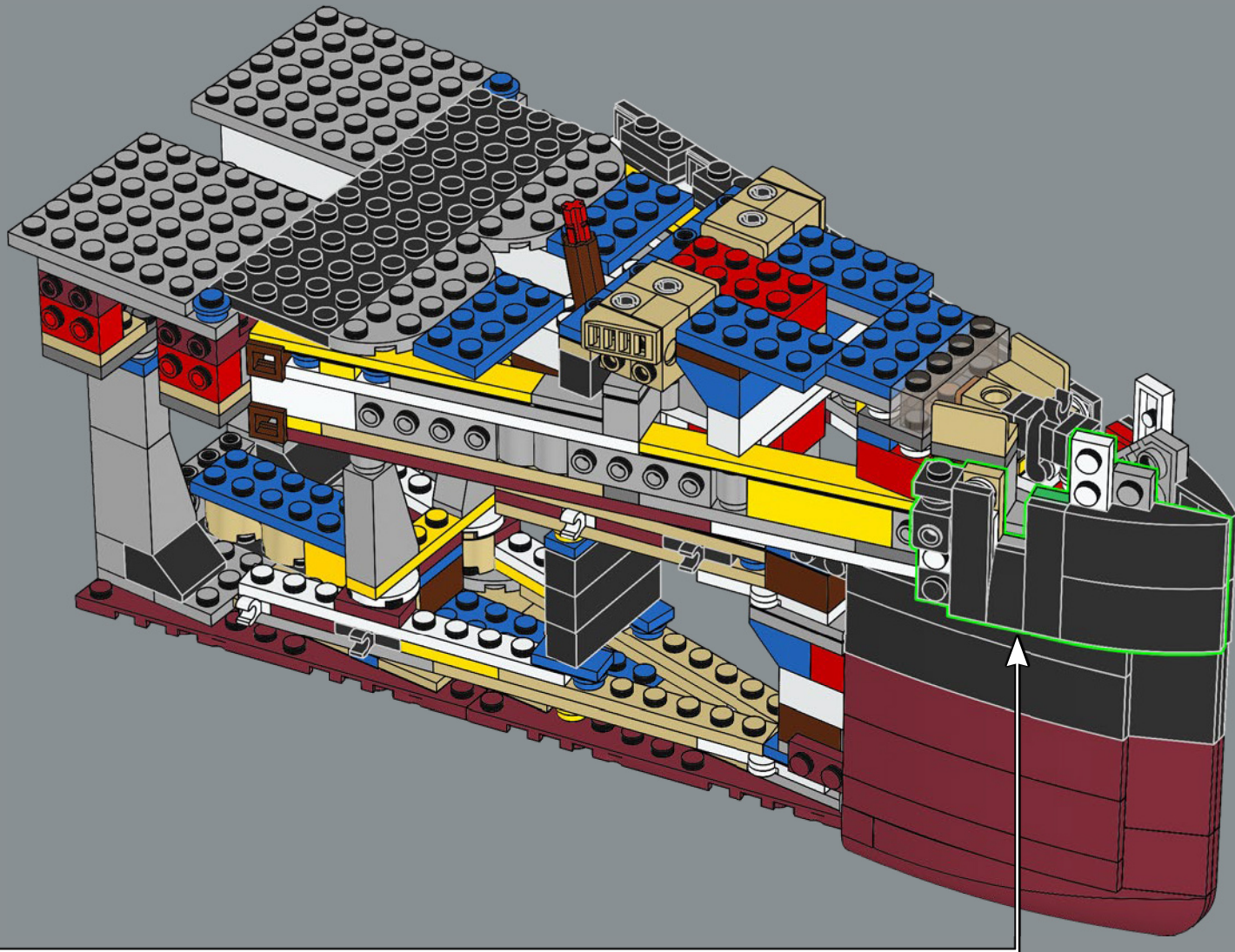

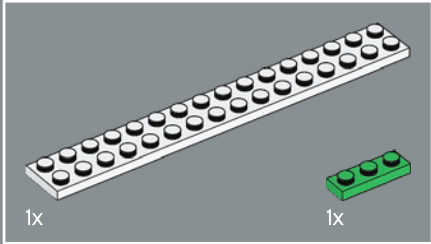
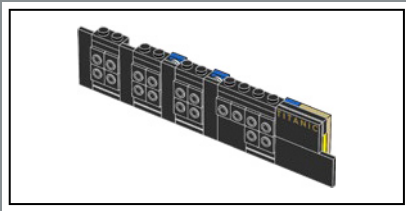

85

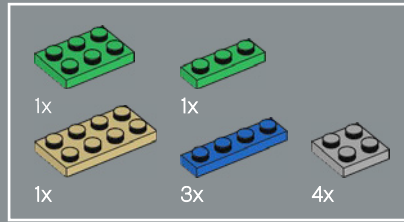
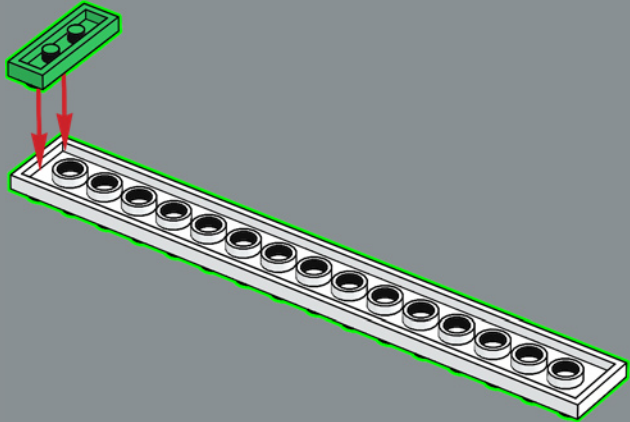

86

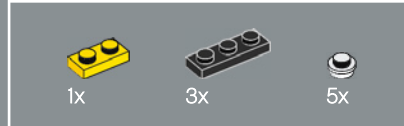
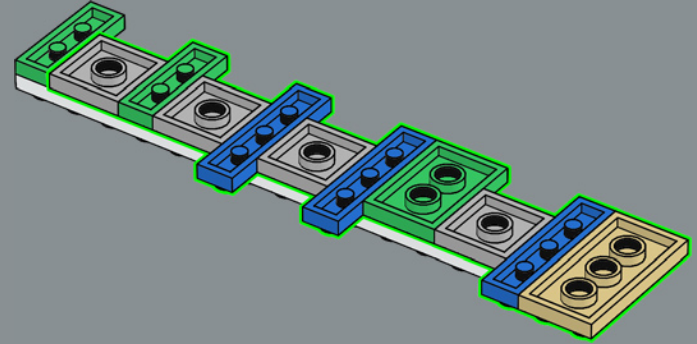

87

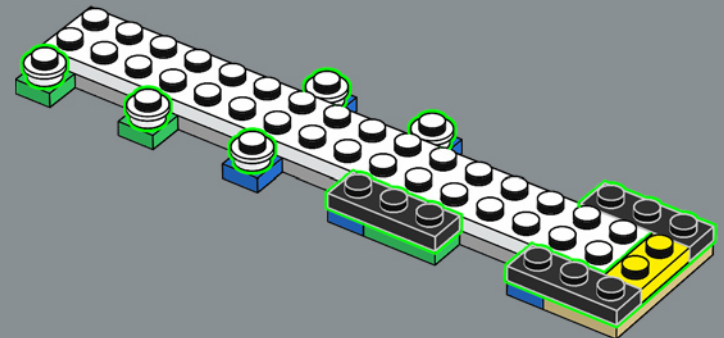

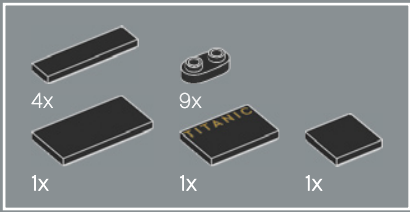

88

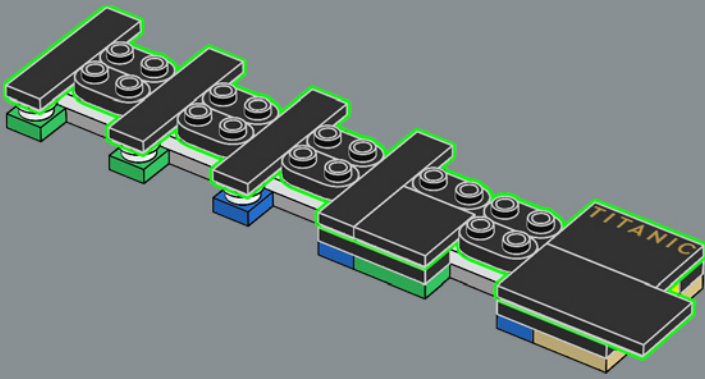

89

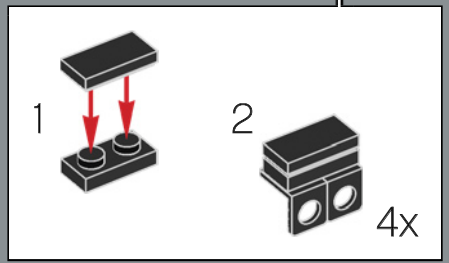
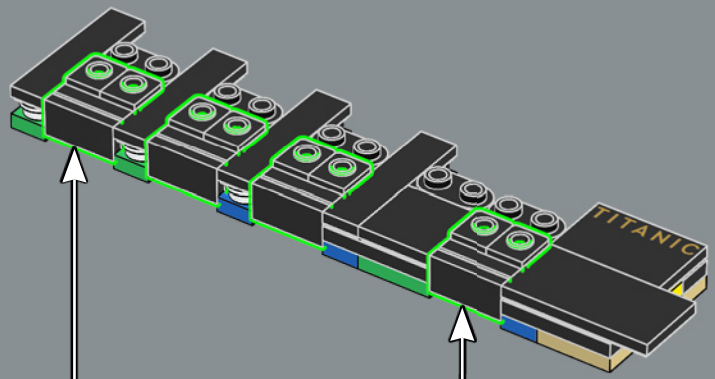

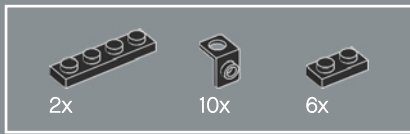

90

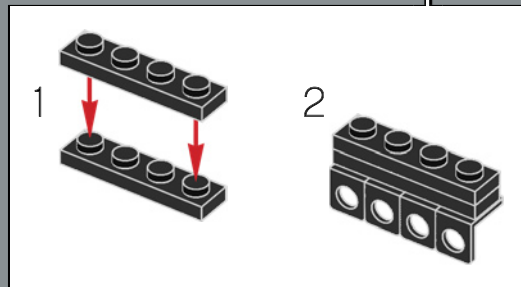
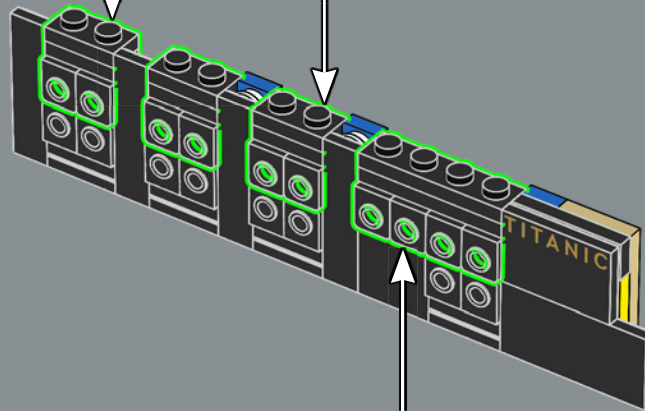
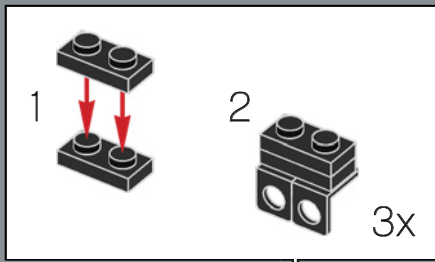

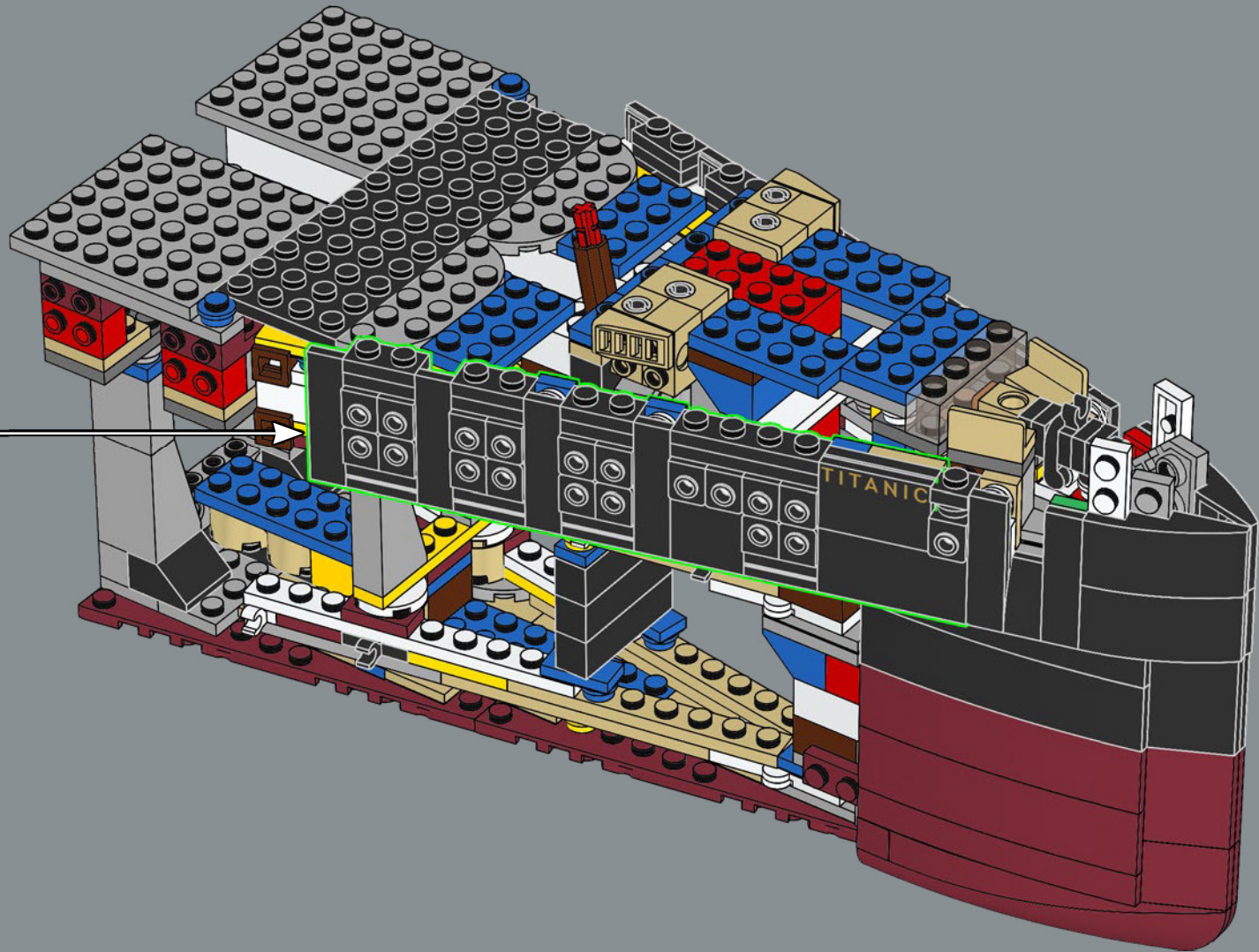

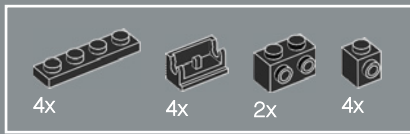

92

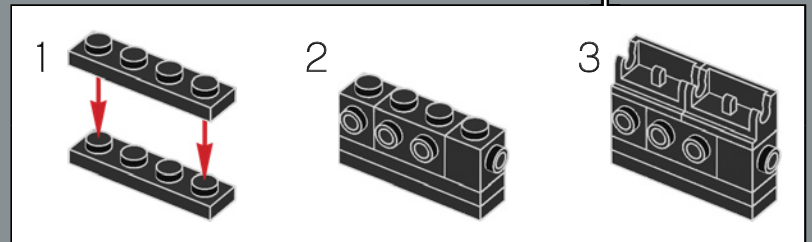
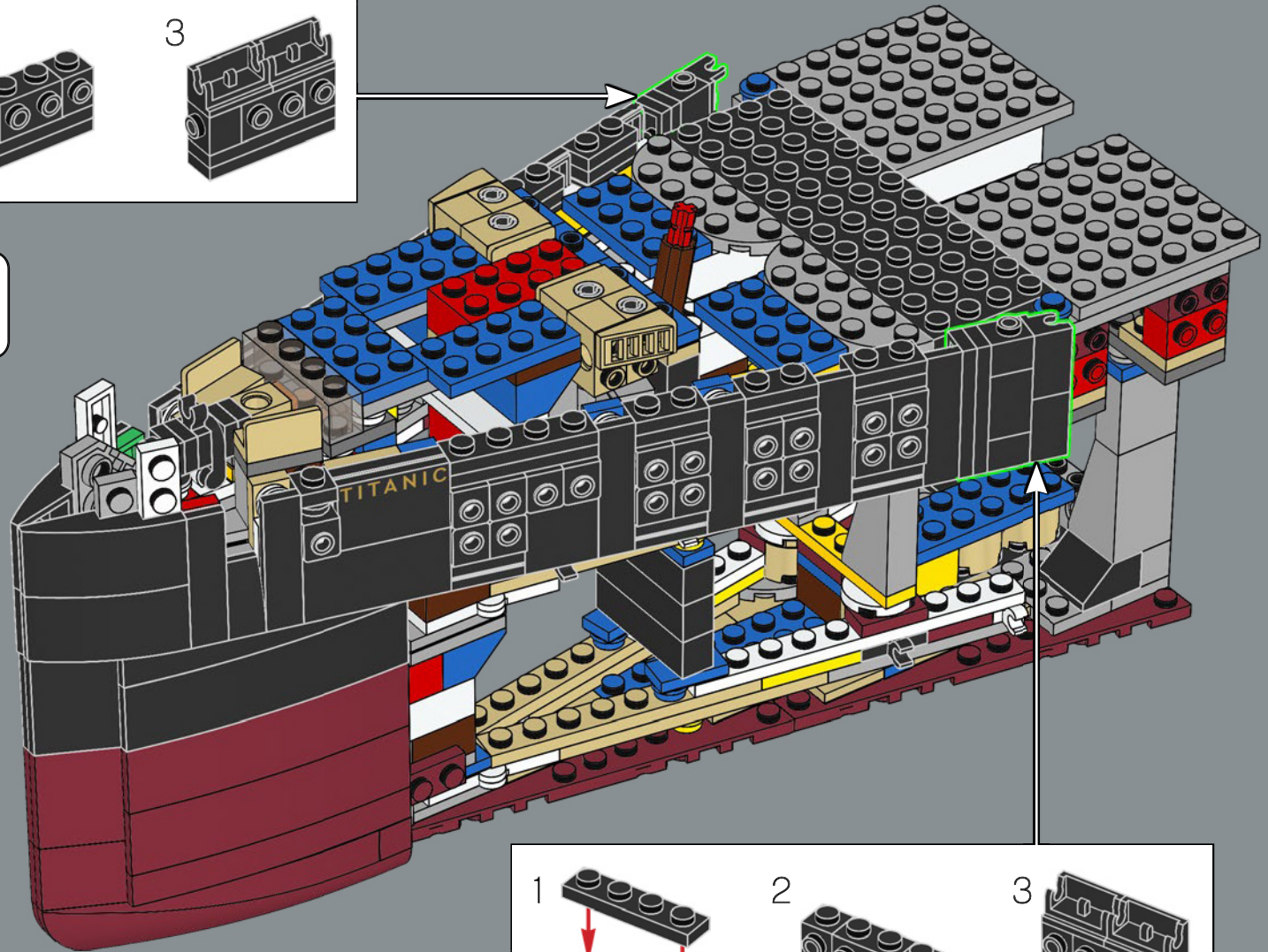
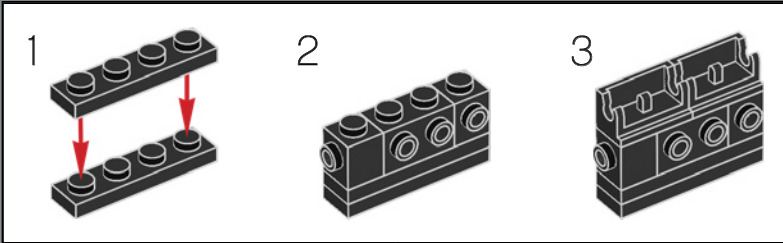

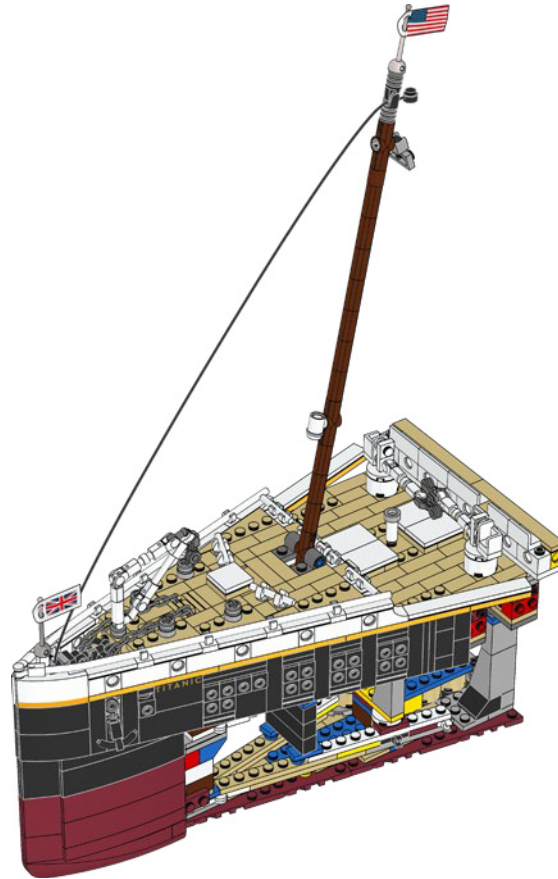

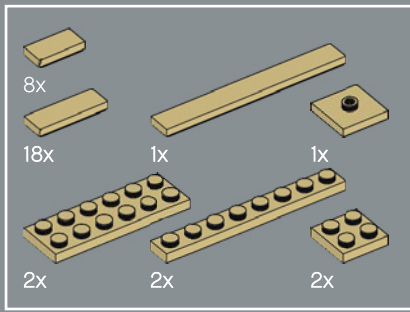

93

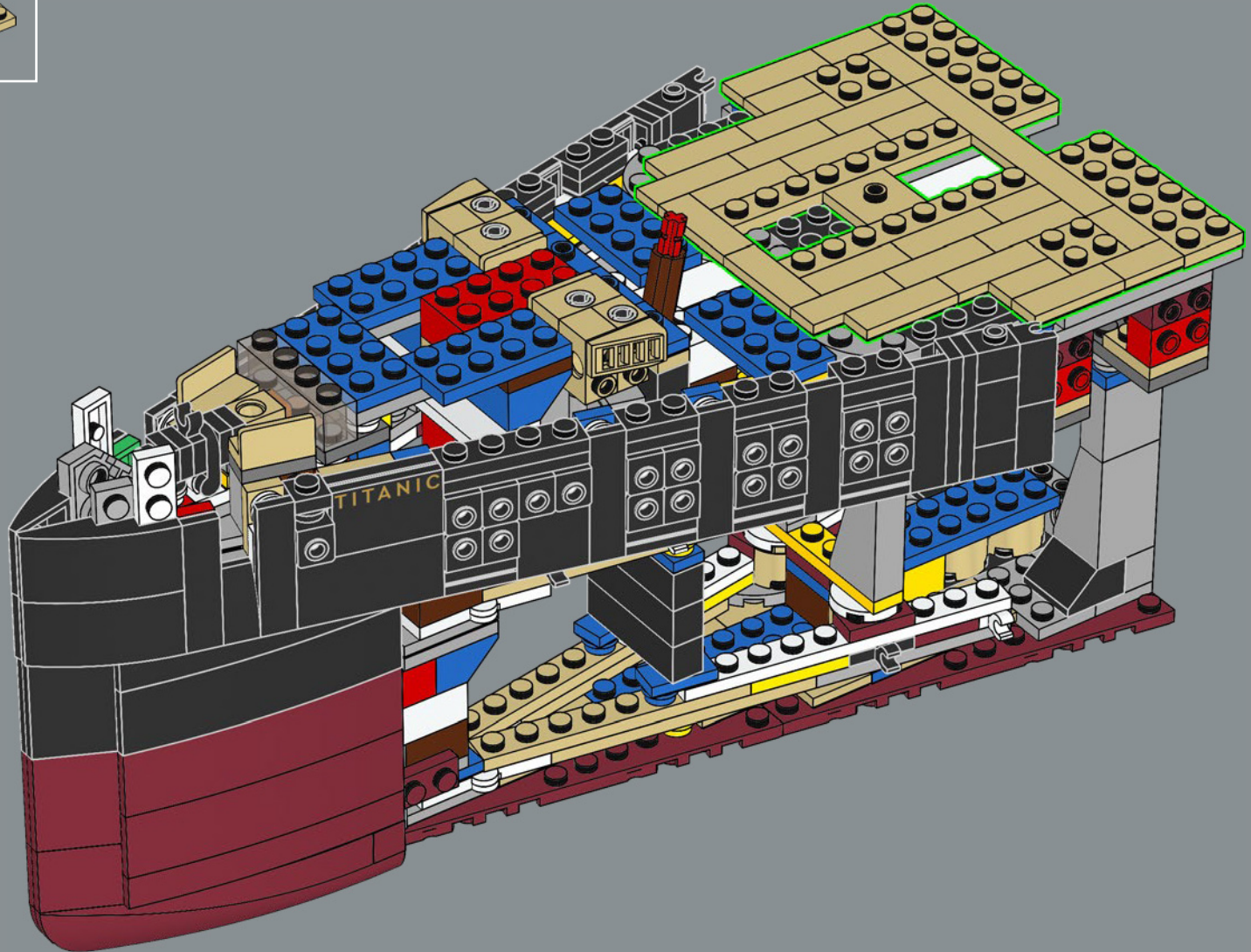

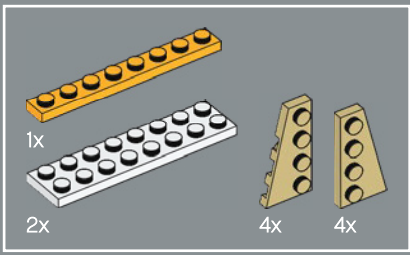

94

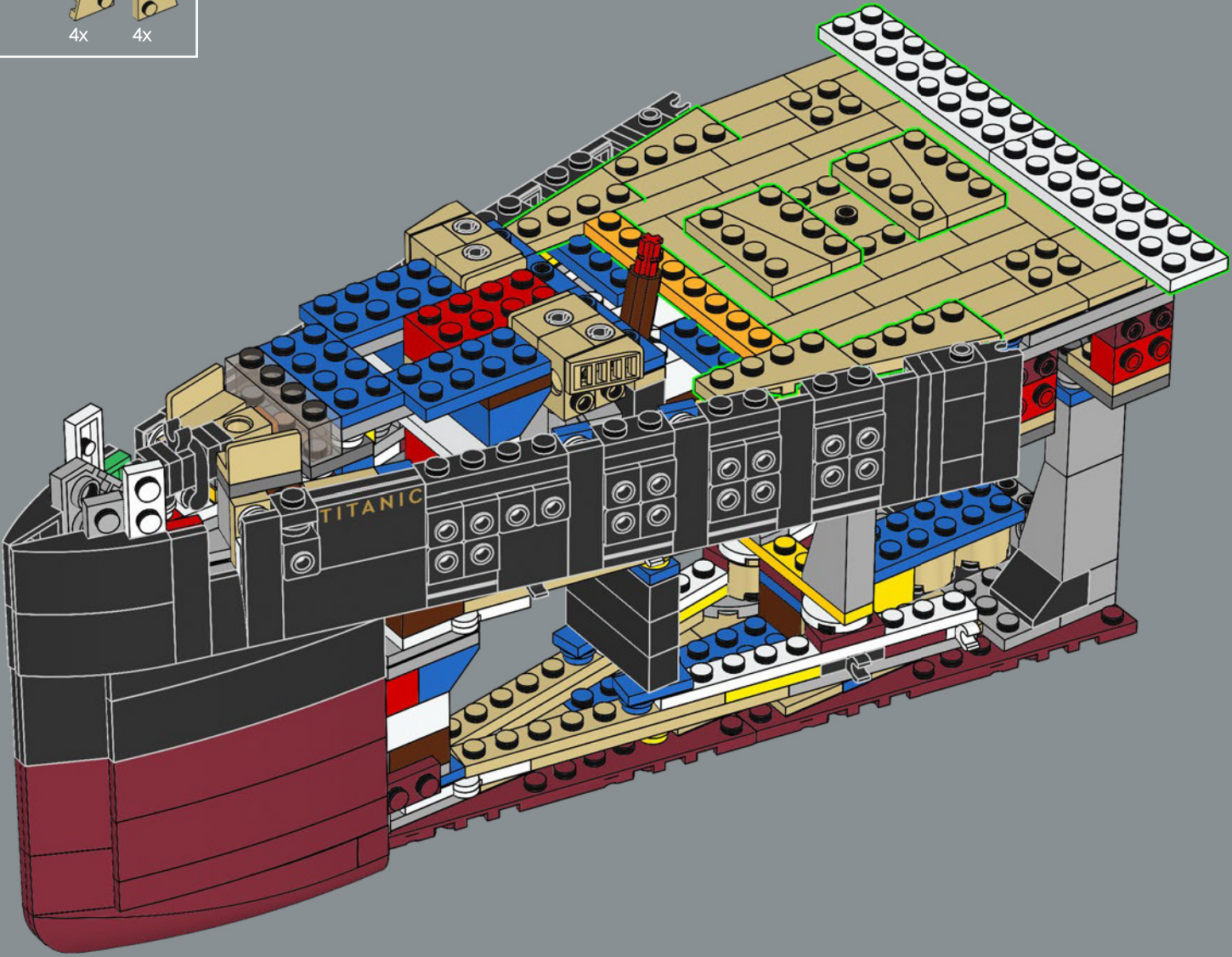

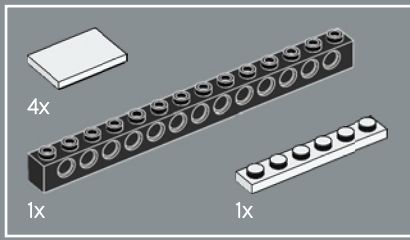

95

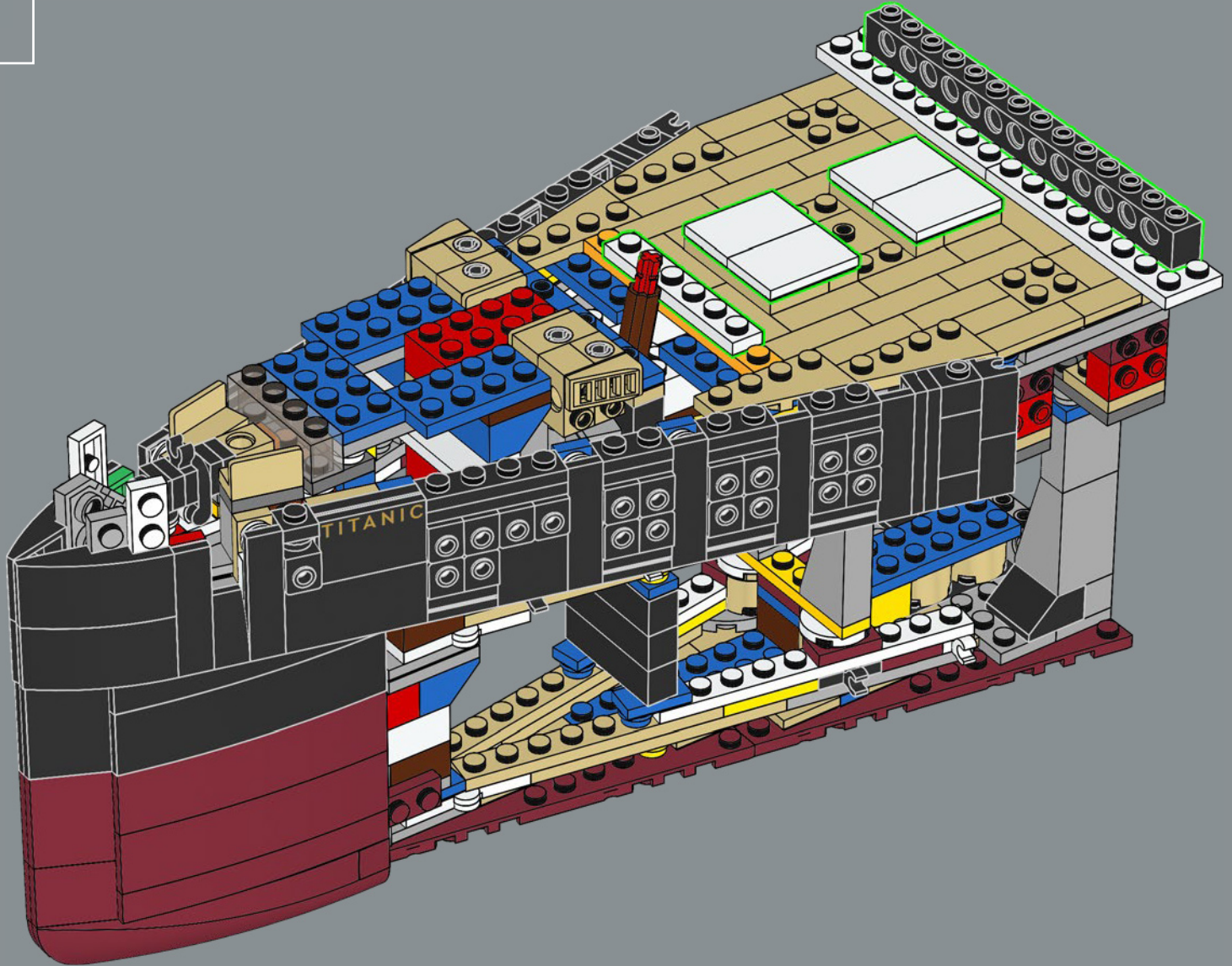

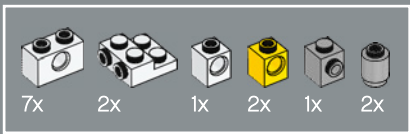

96

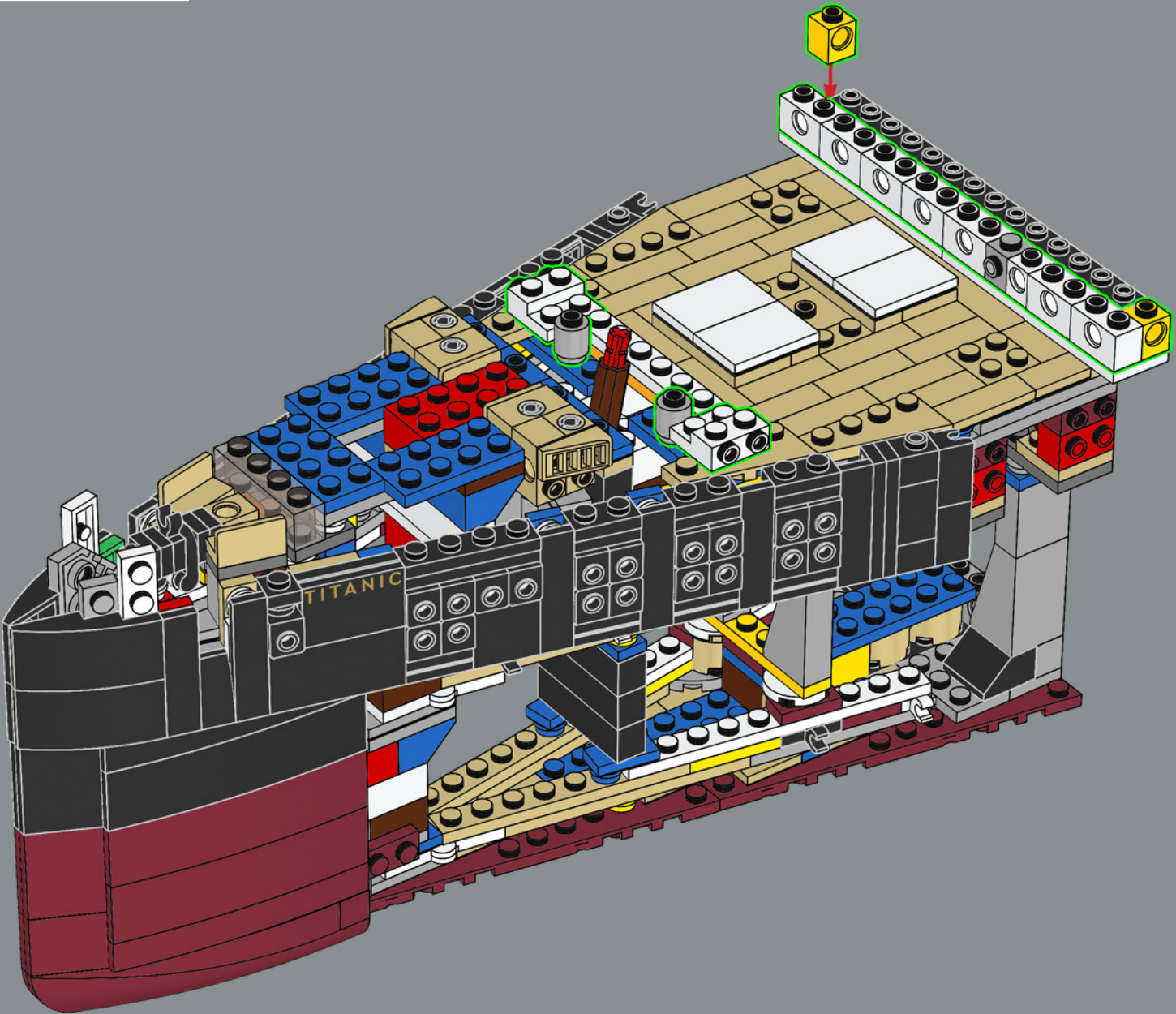

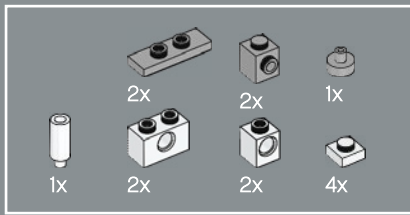

97

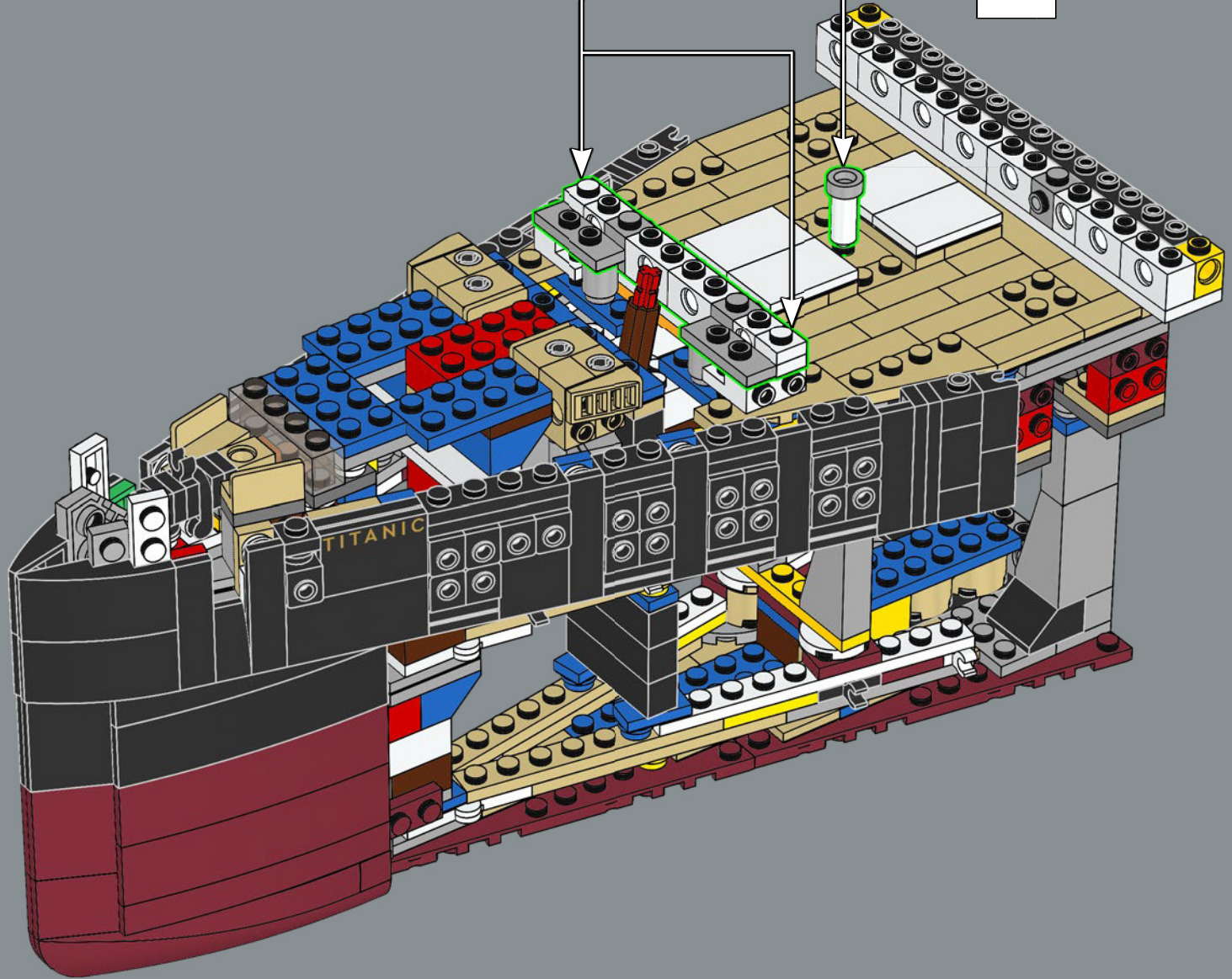
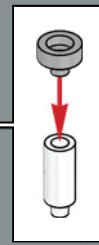
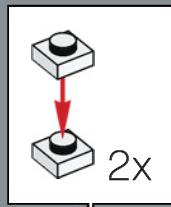

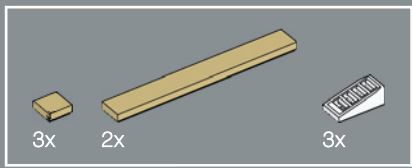

98

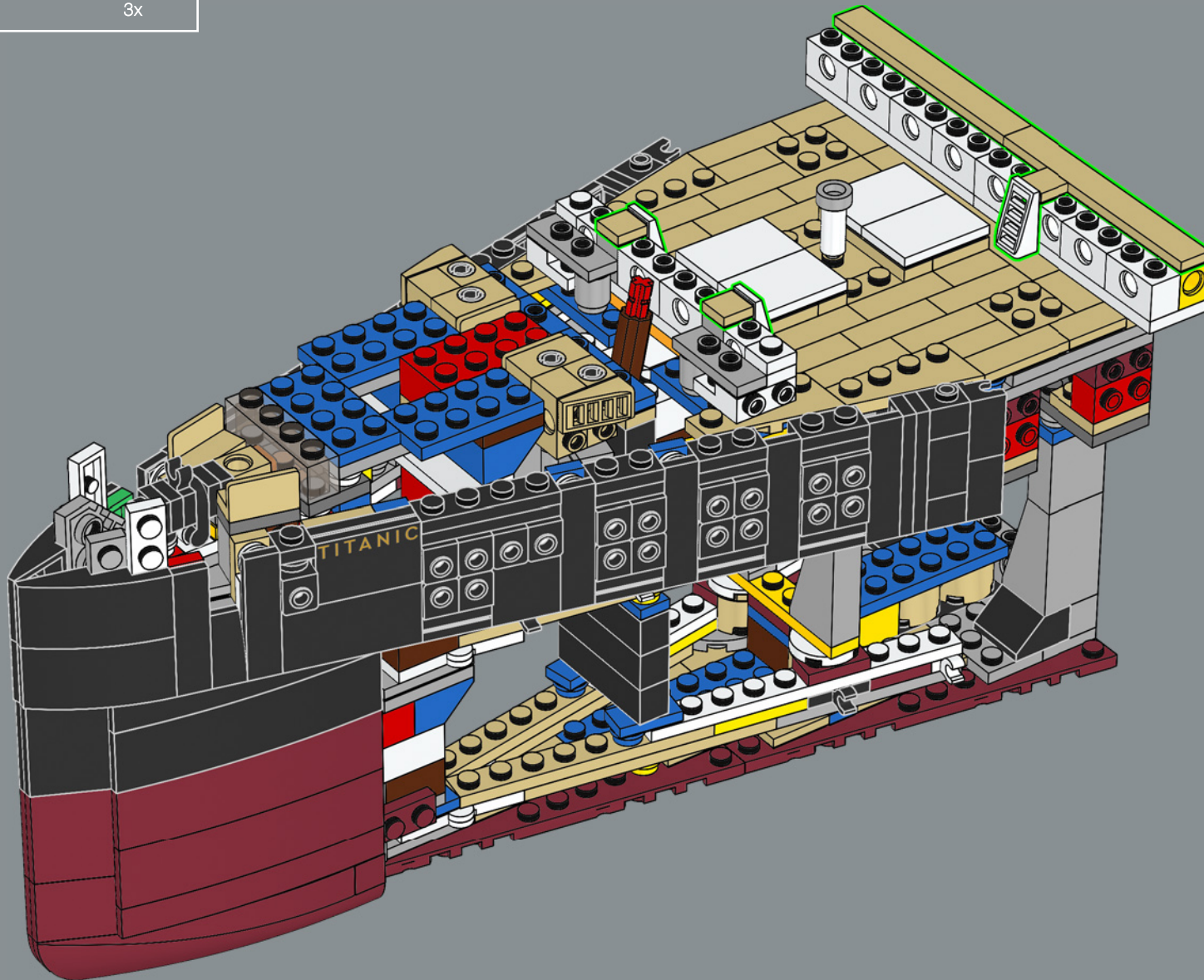

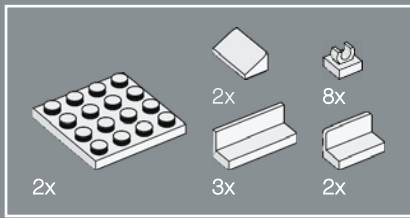

99

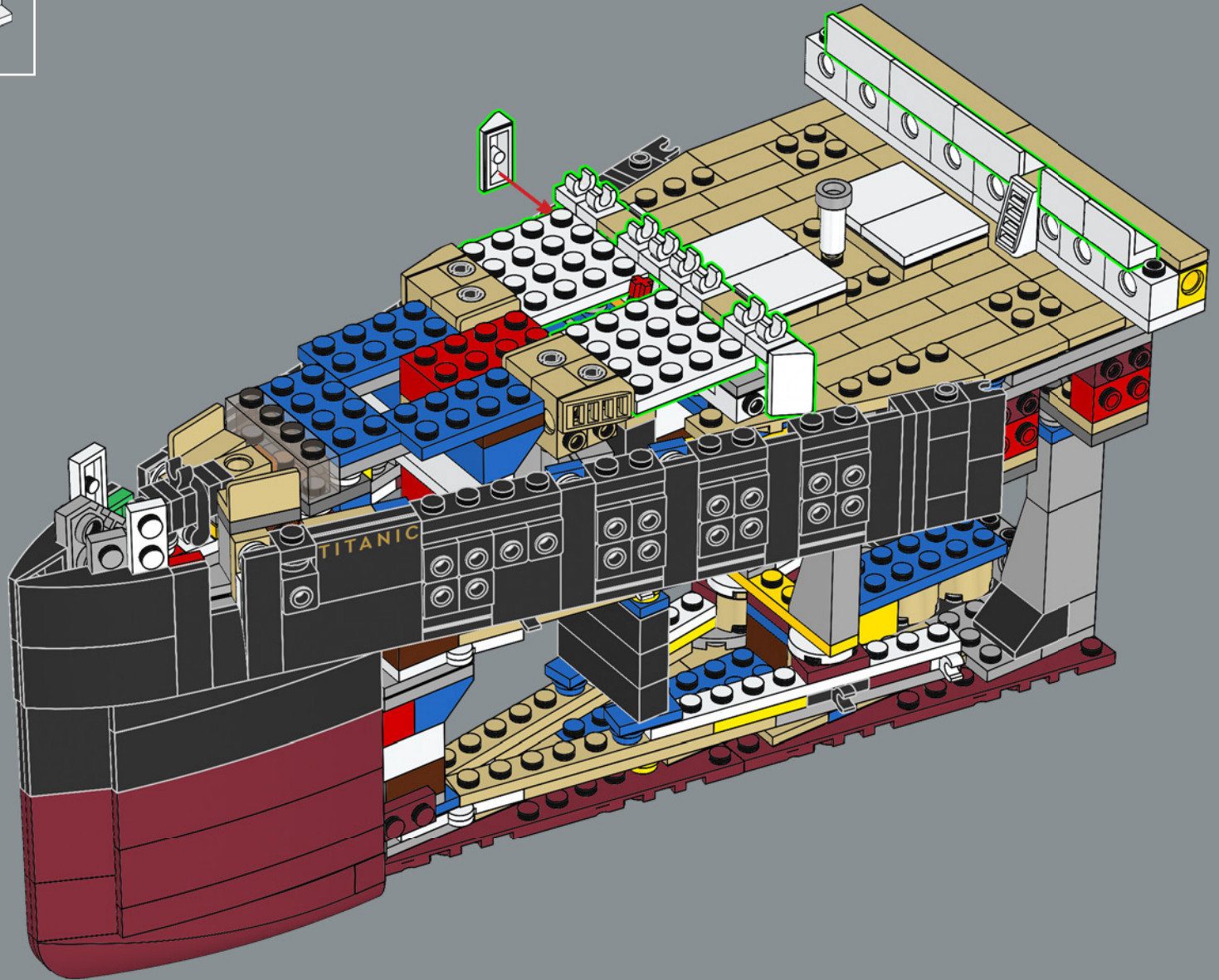

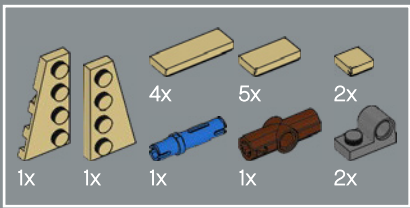

100

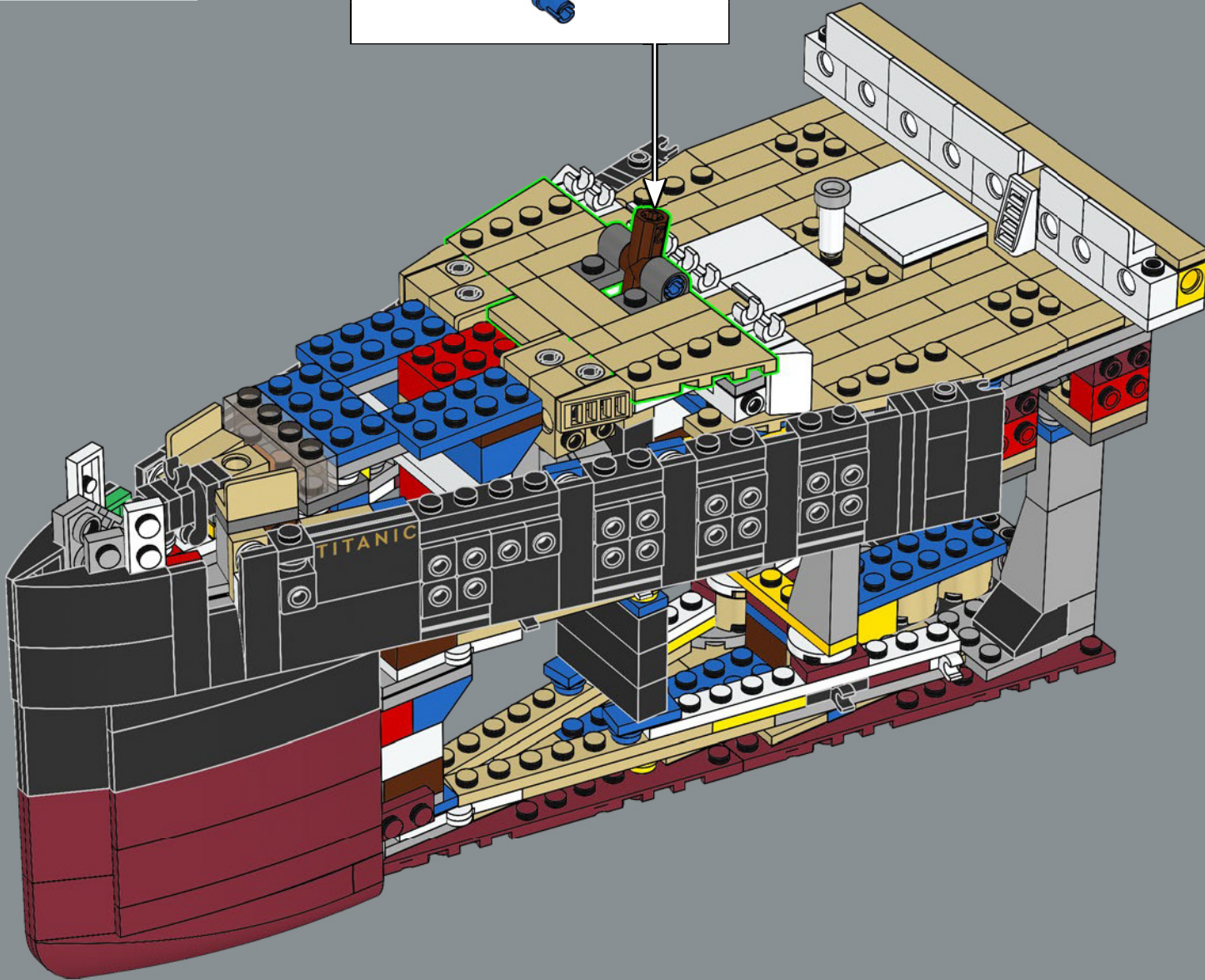
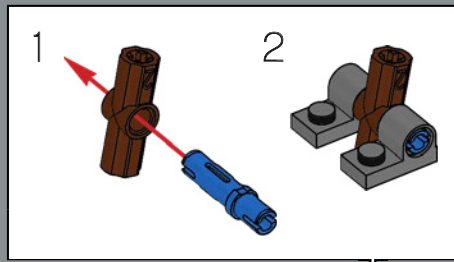

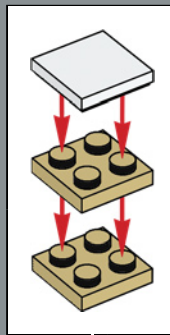
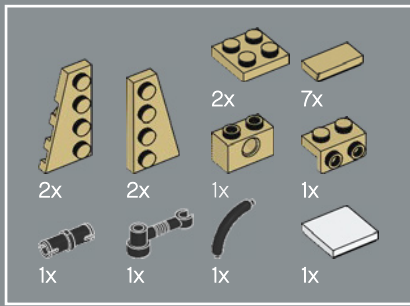

101

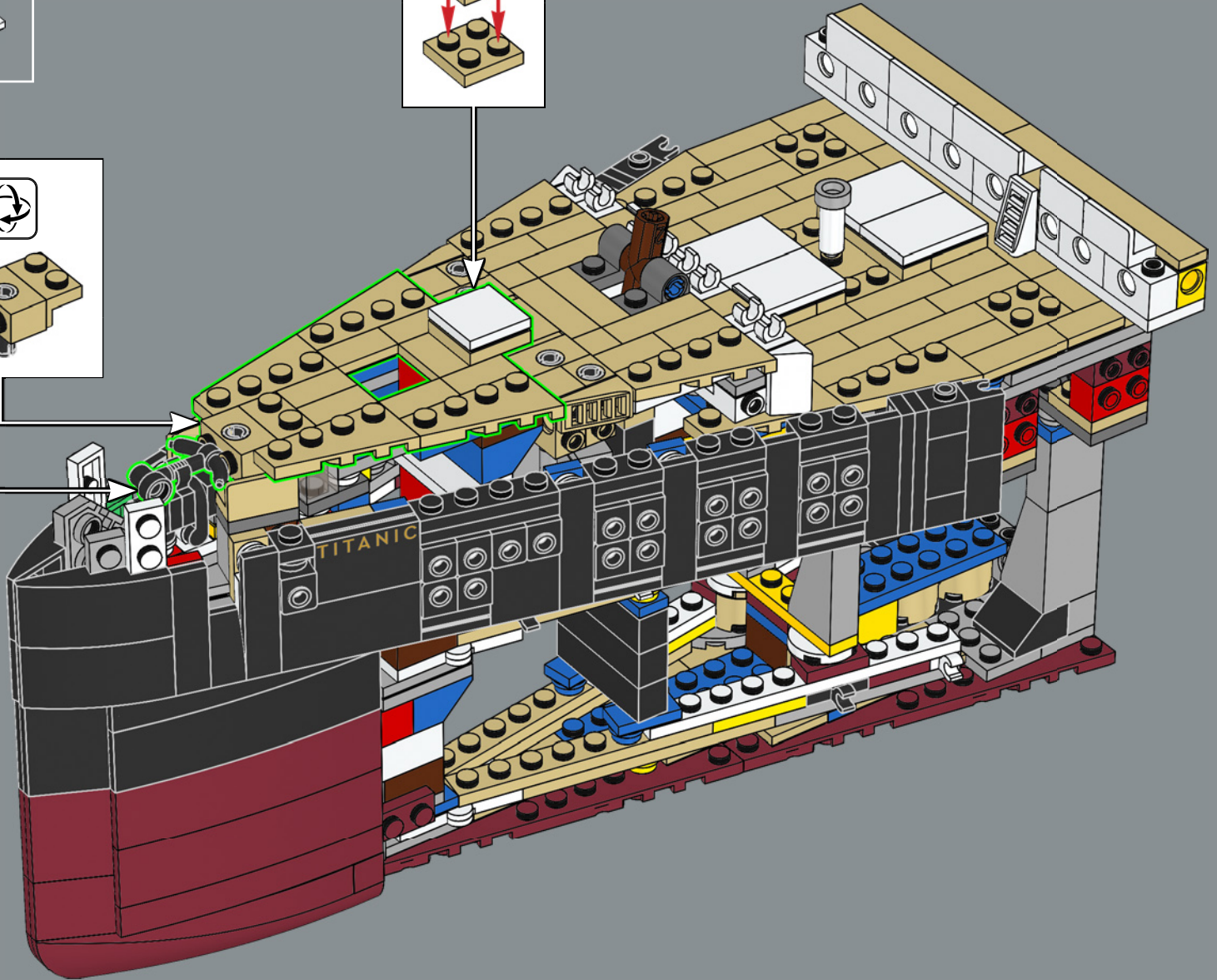
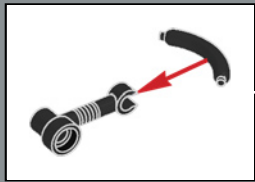
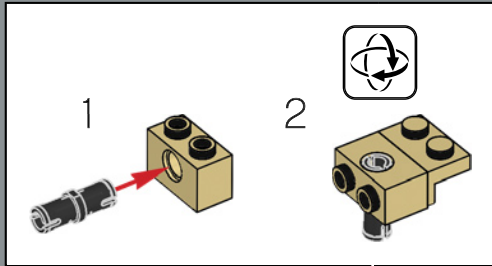

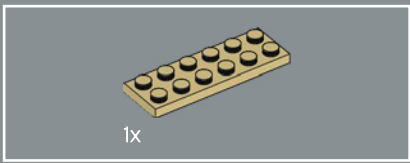

102

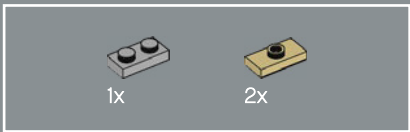
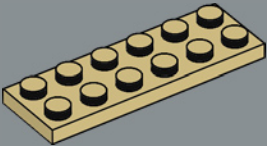

103

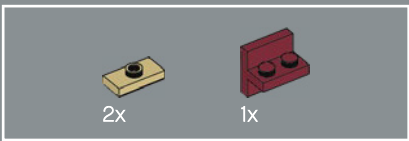
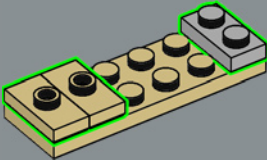

104

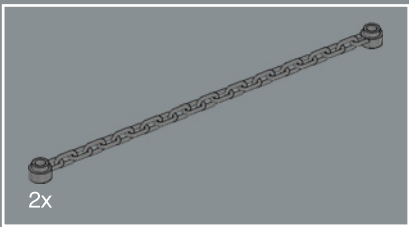
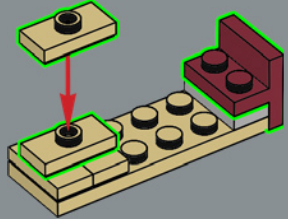

105

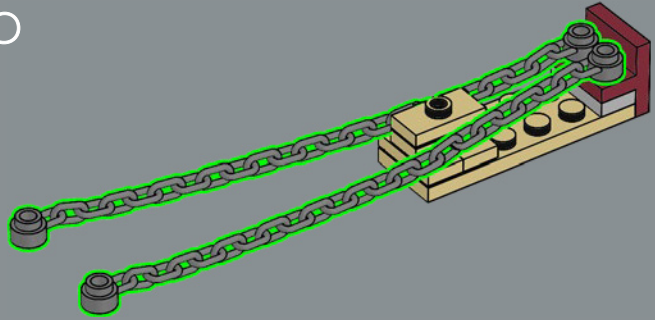

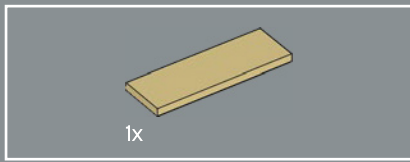

106

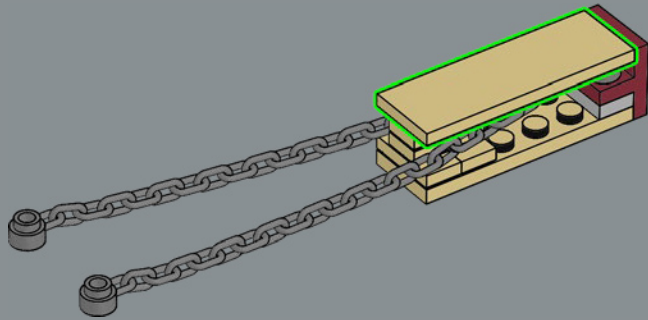

107

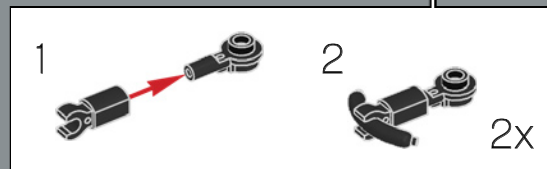
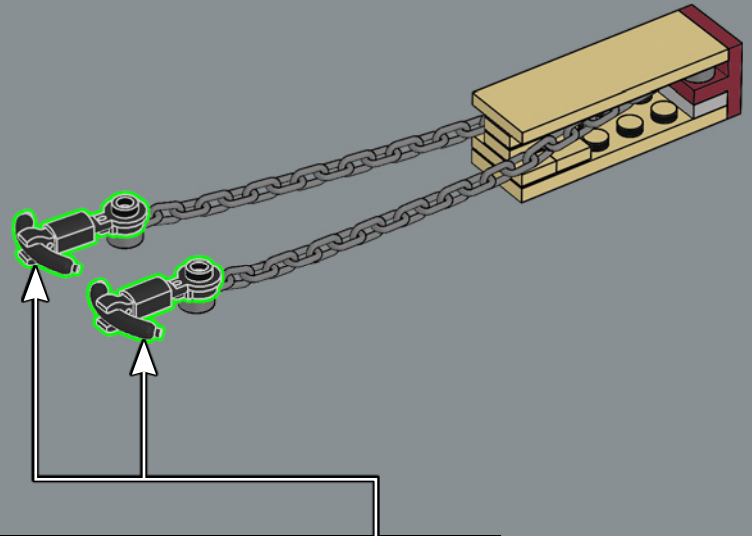

El *Titanic* estaba equipado con tres anclas: una en el costado de babor, otra en el costado de estribor y la más pesada en el centro.

108

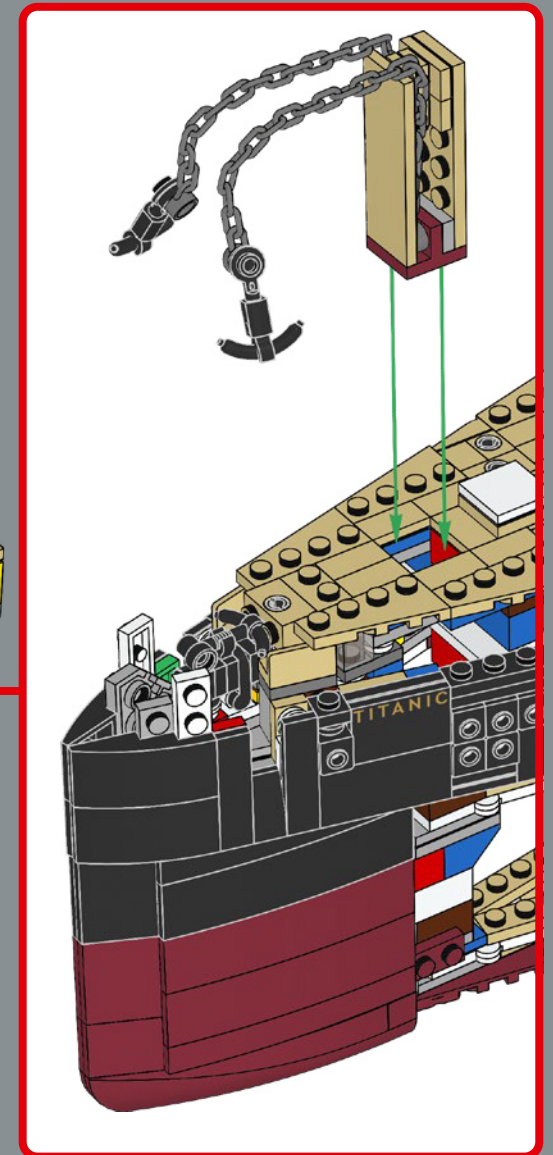
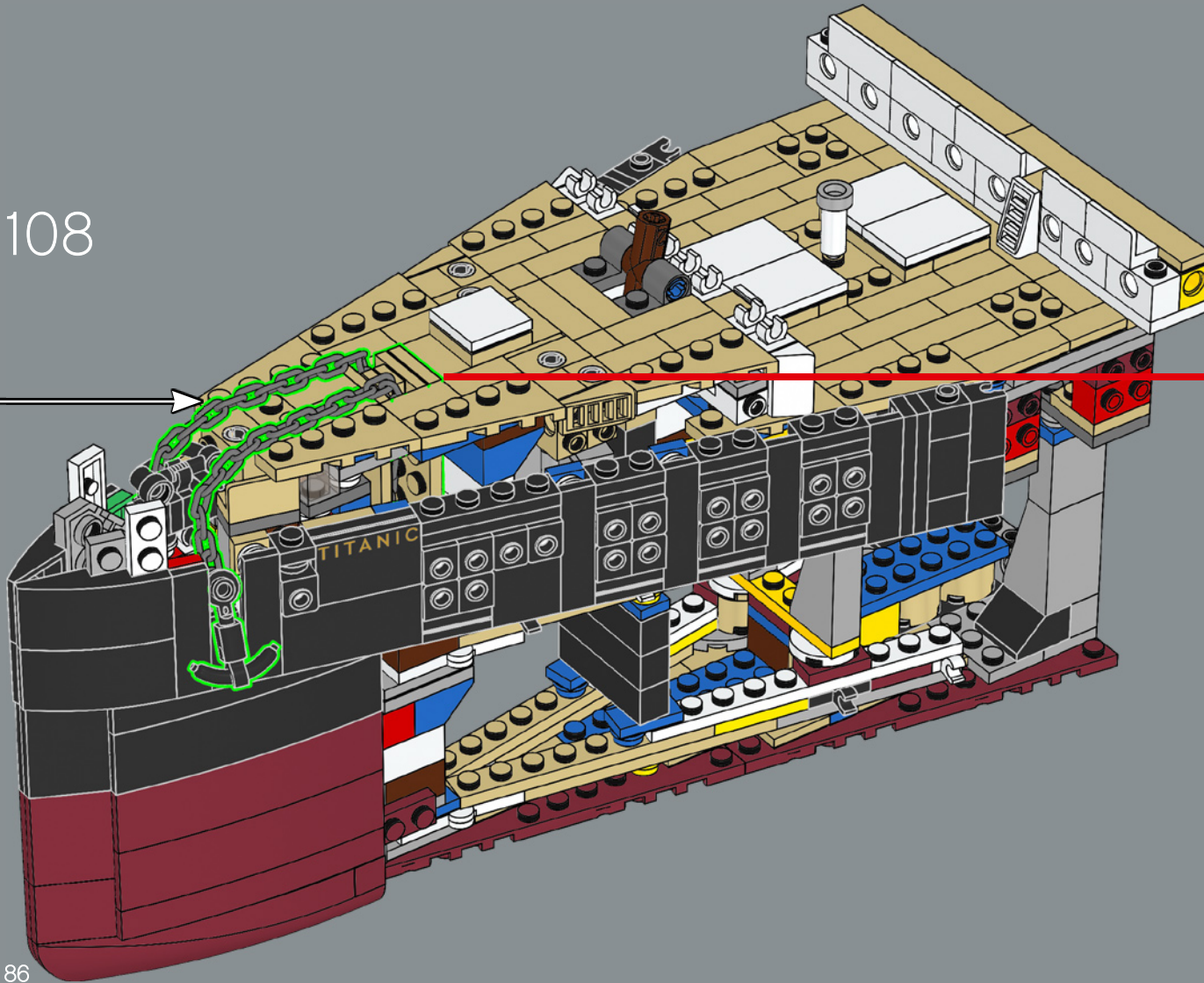

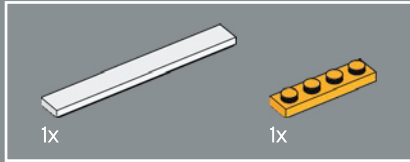
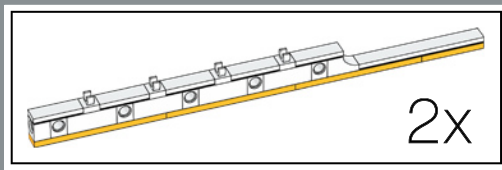

109

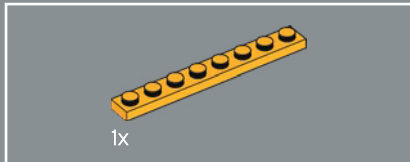
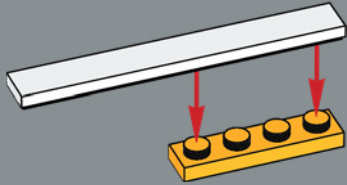

110

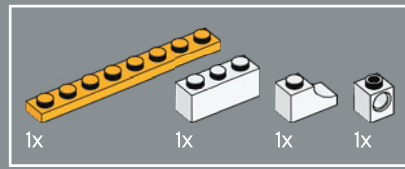
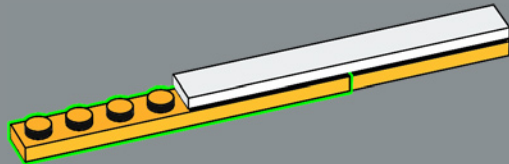

111

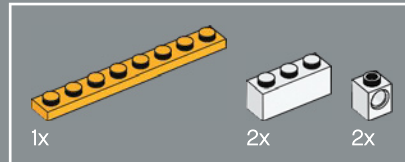
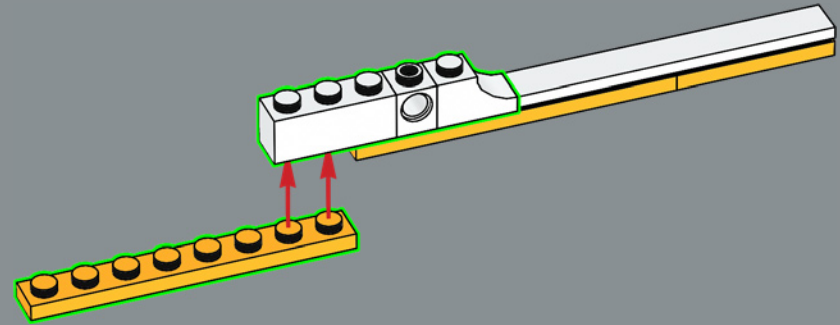

112

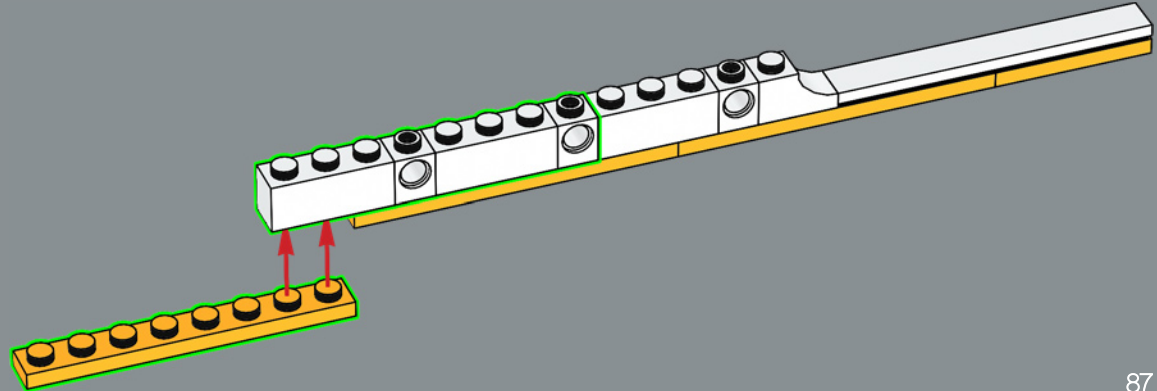

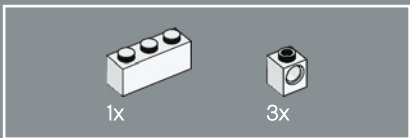

113

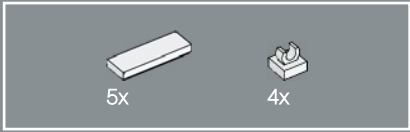
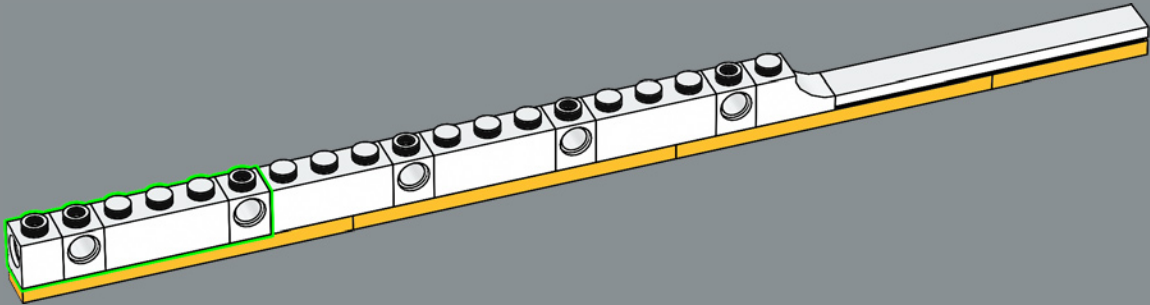

114

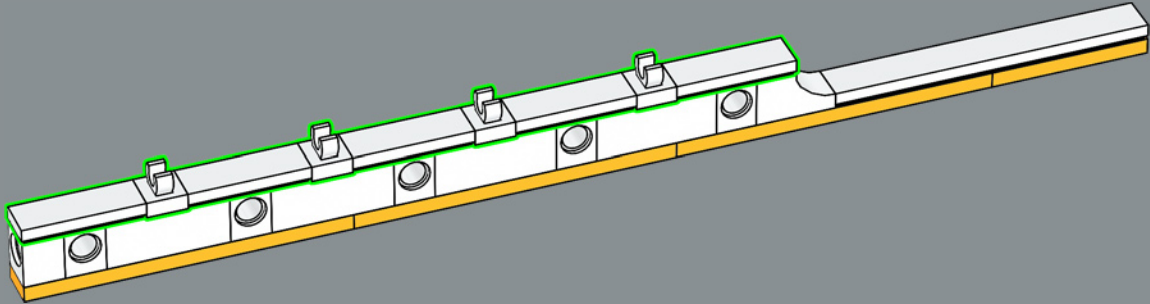

2x

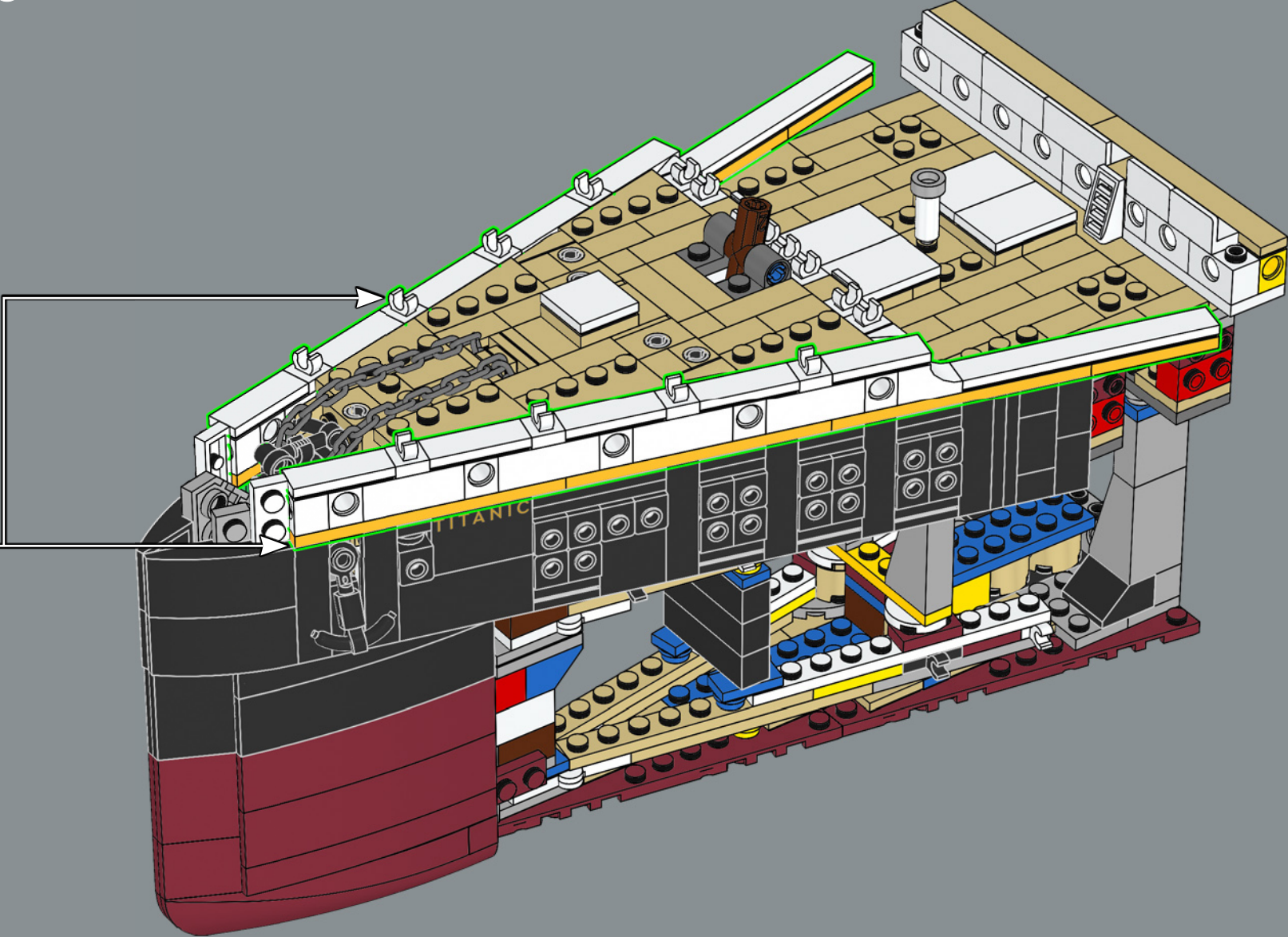

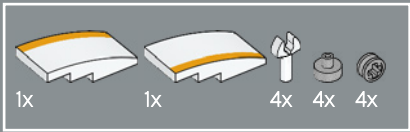

116

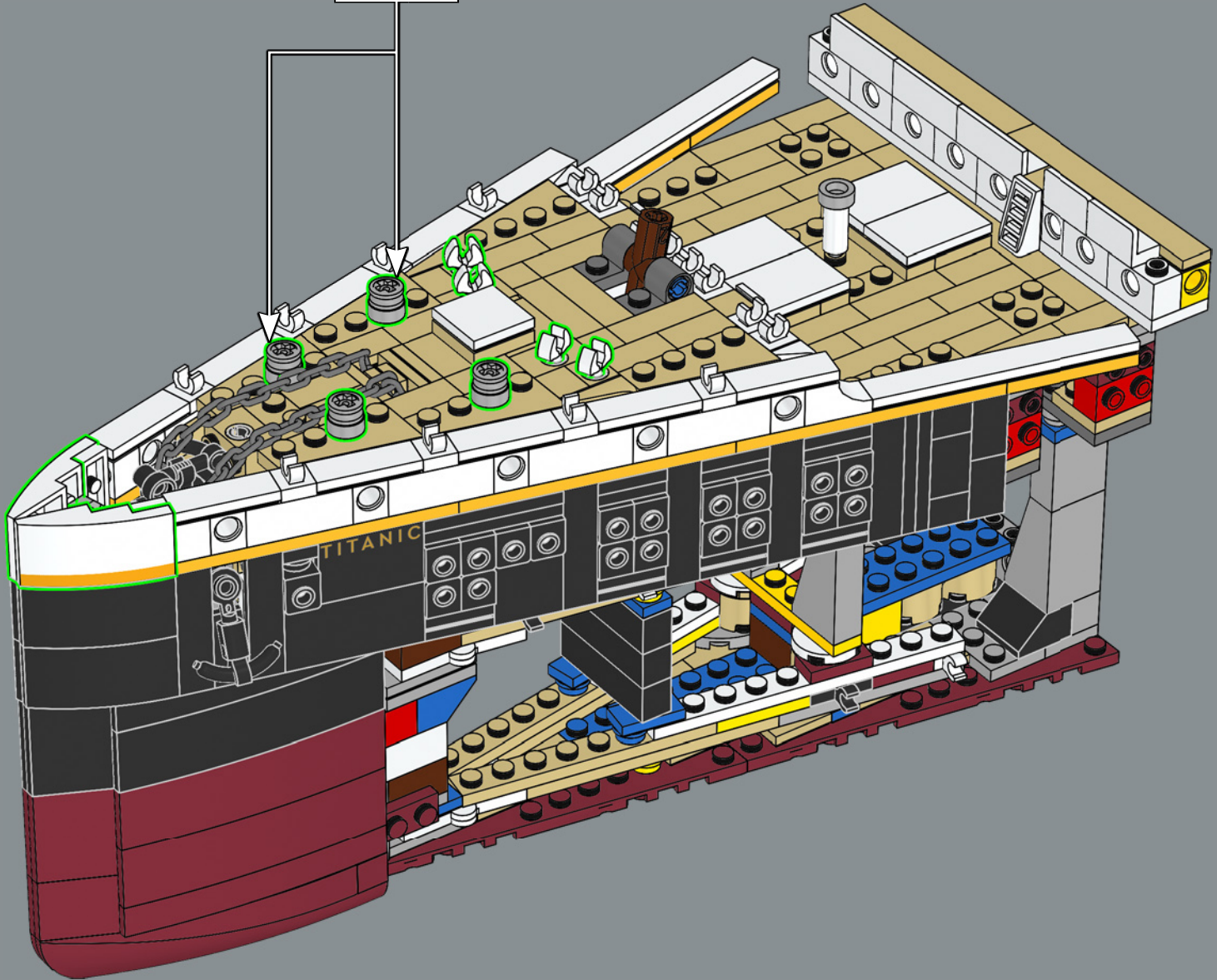
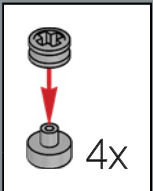

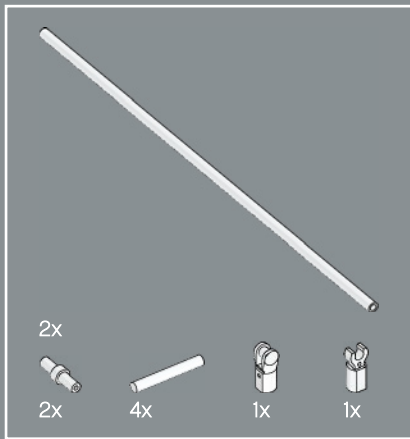

117

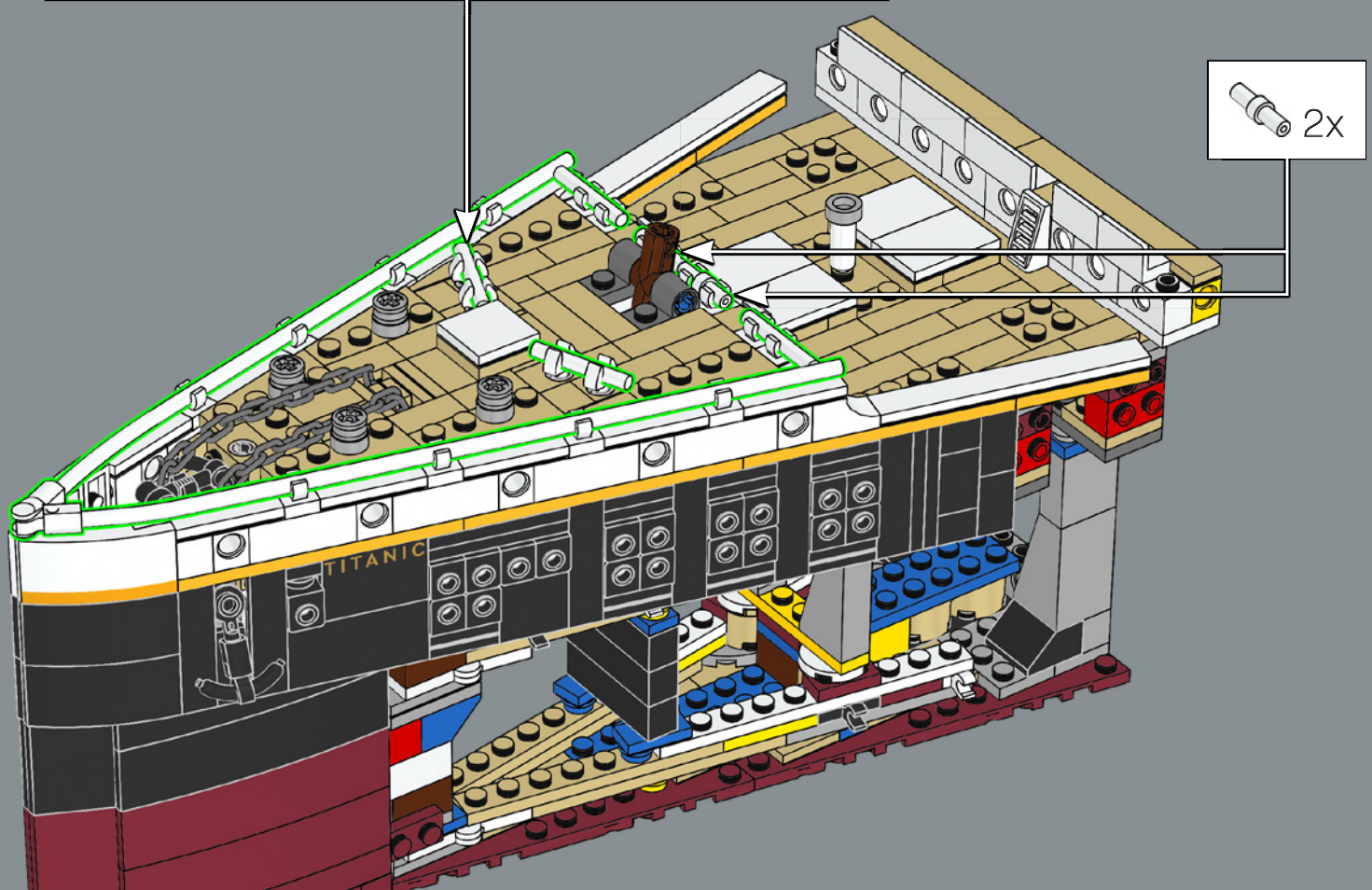
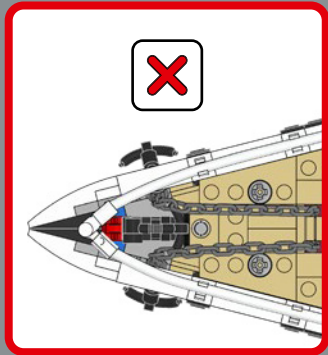
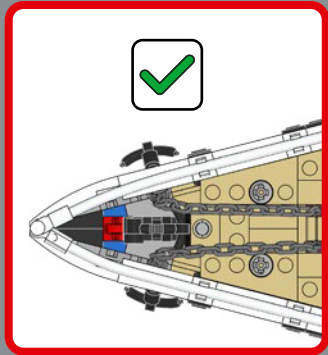
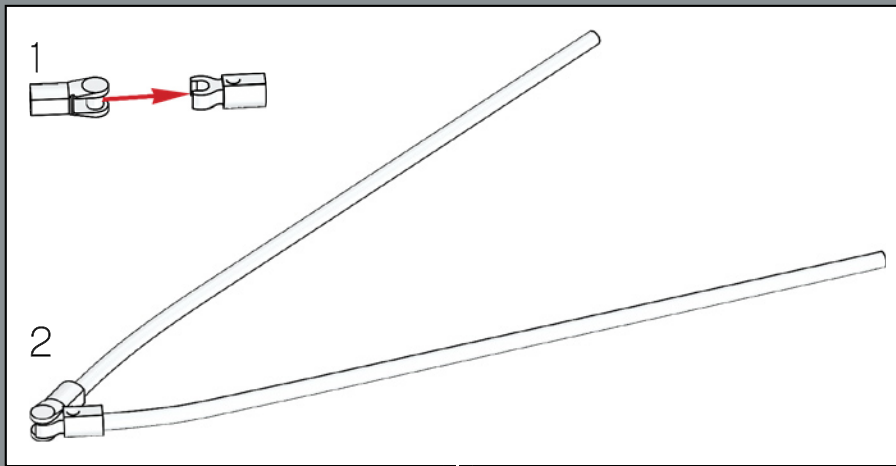



118

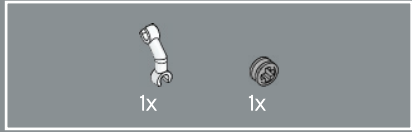

119



120

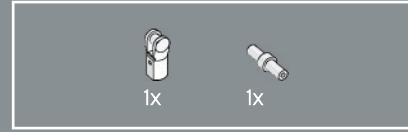
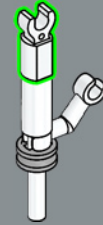

121

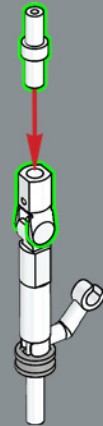



122

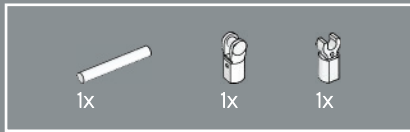
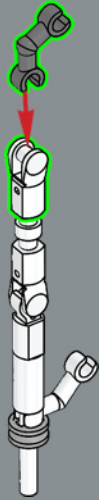

123

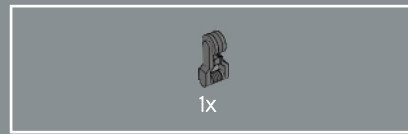
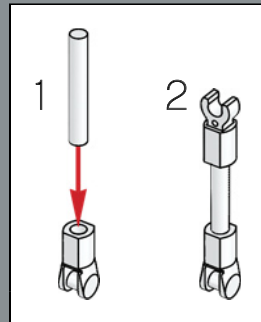
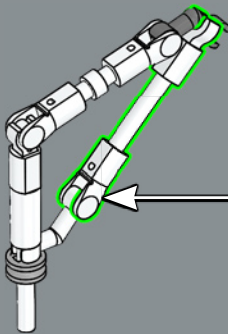

124

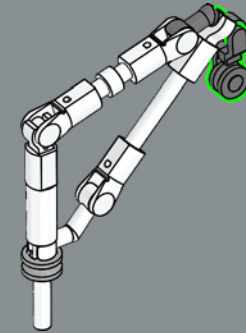

125

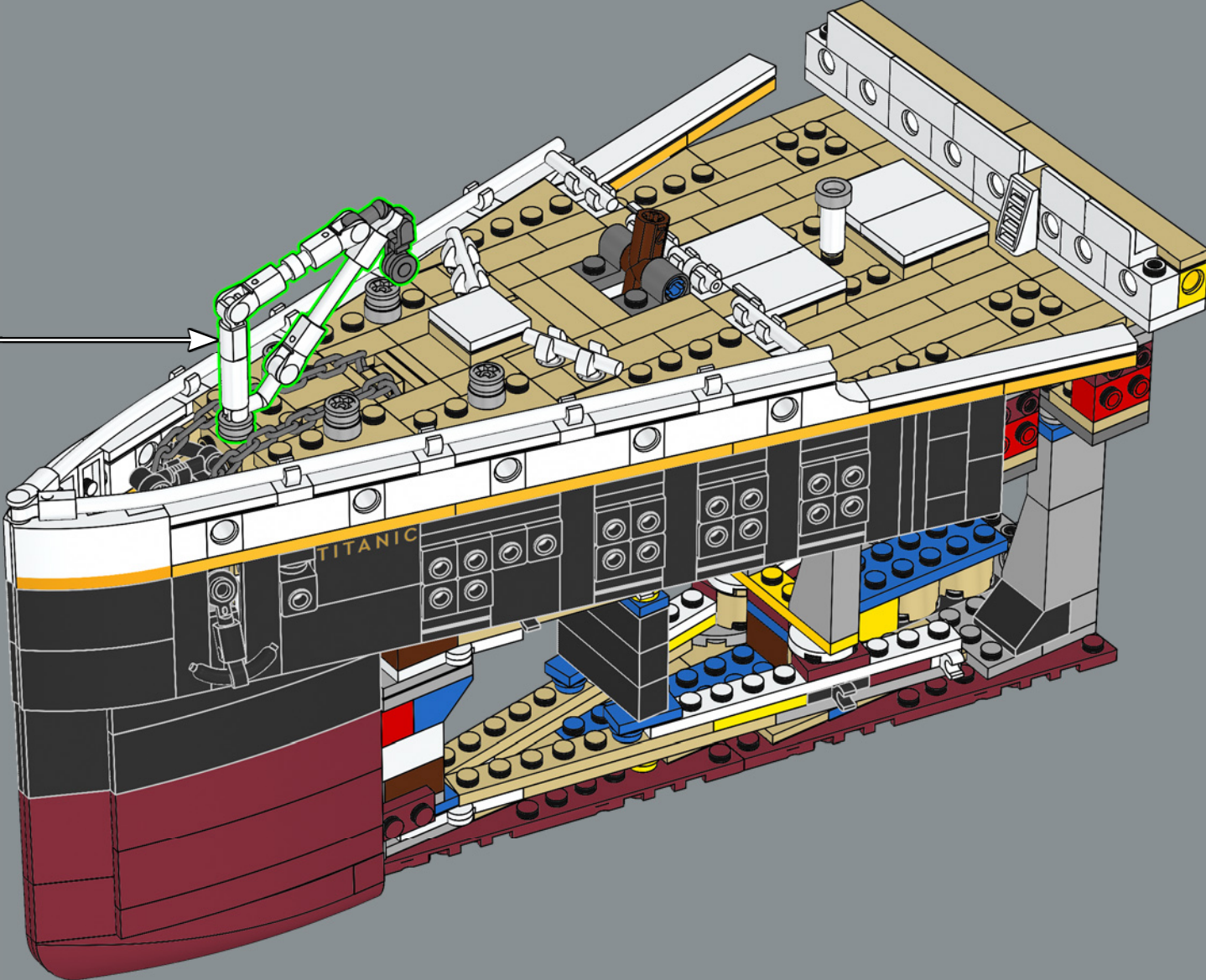

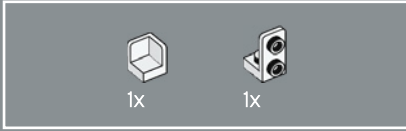
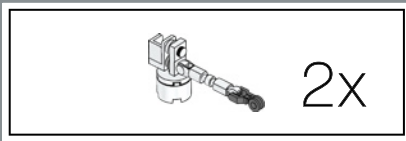

126

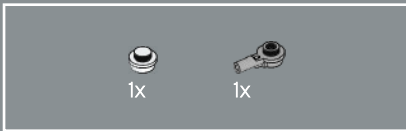

127

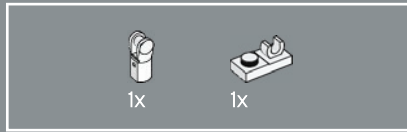

128

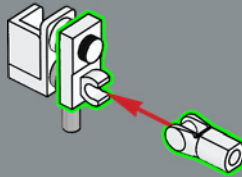

129

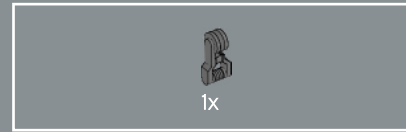
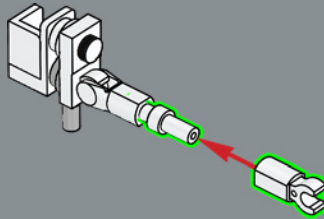

130

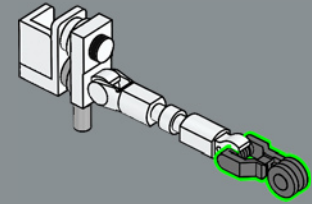

131

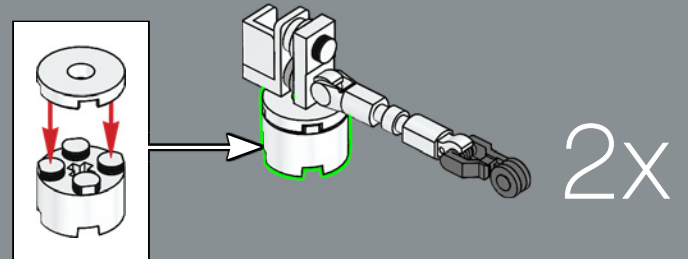

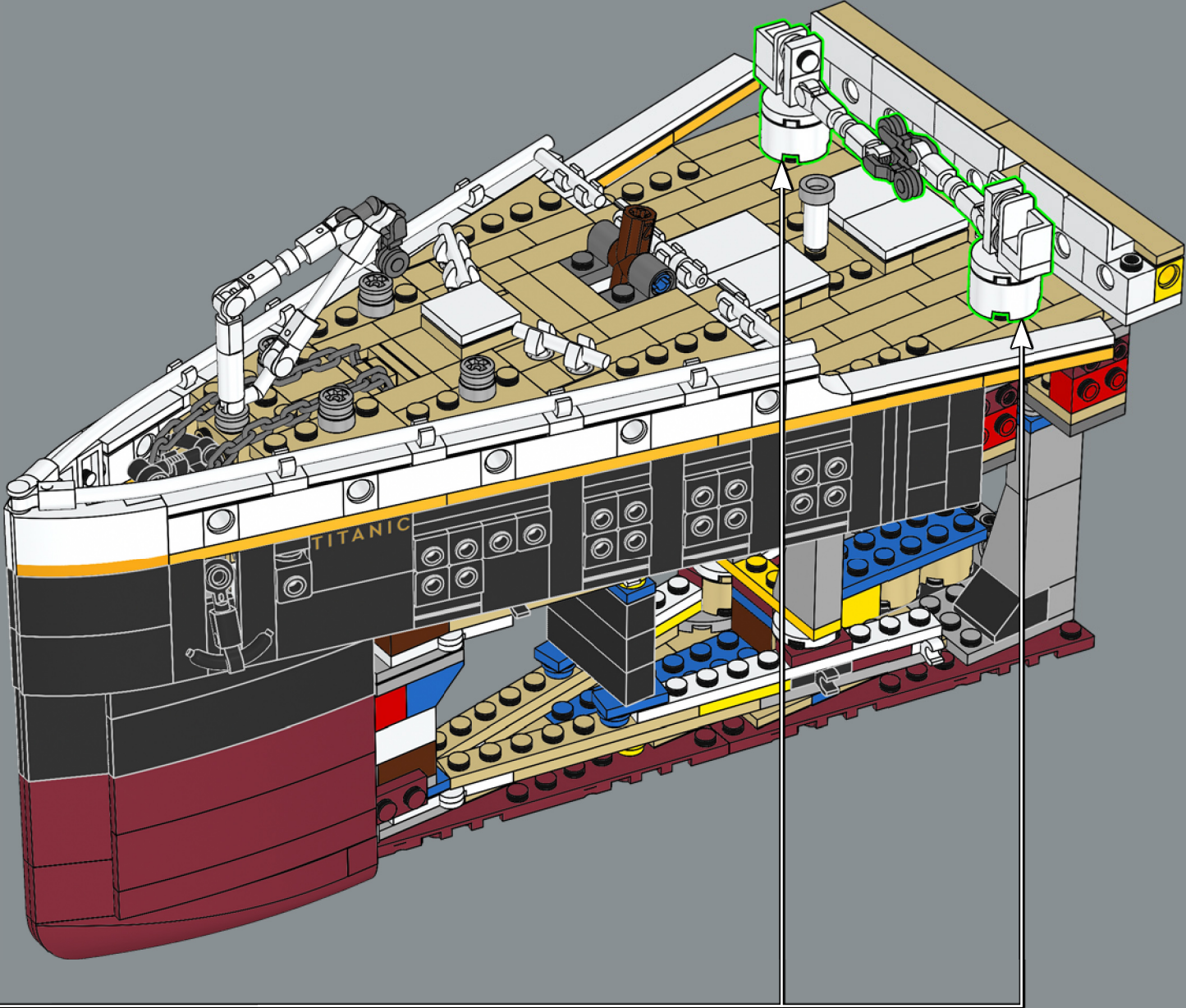

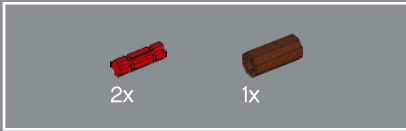
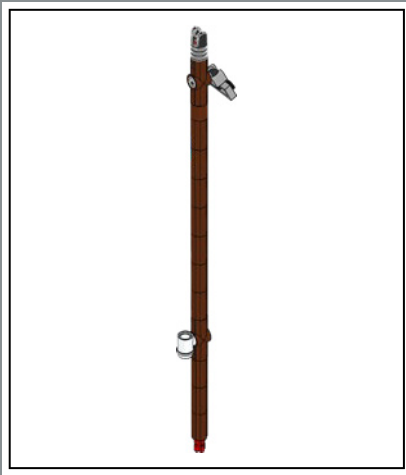

133

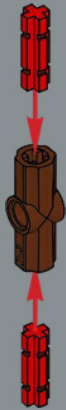

134

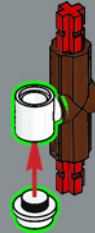

135

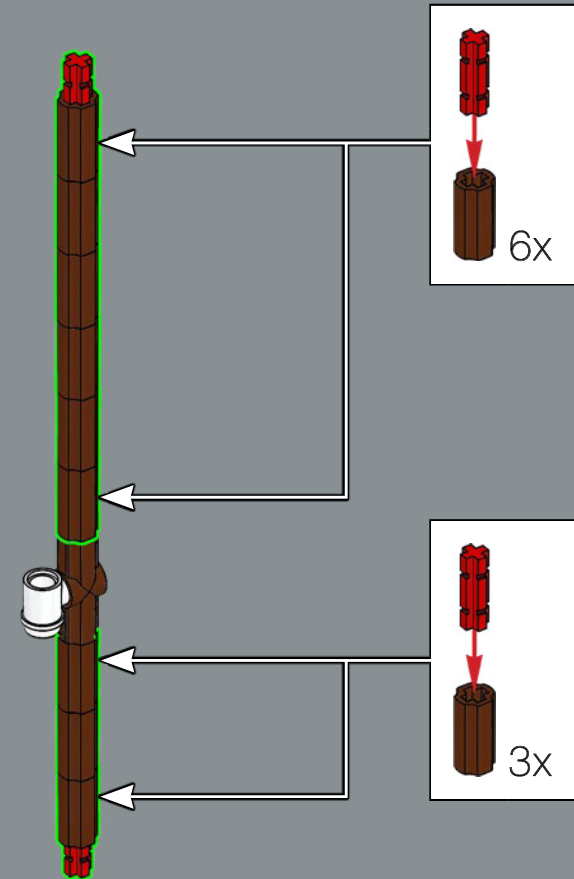

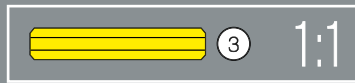
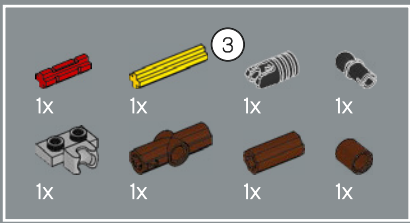

136

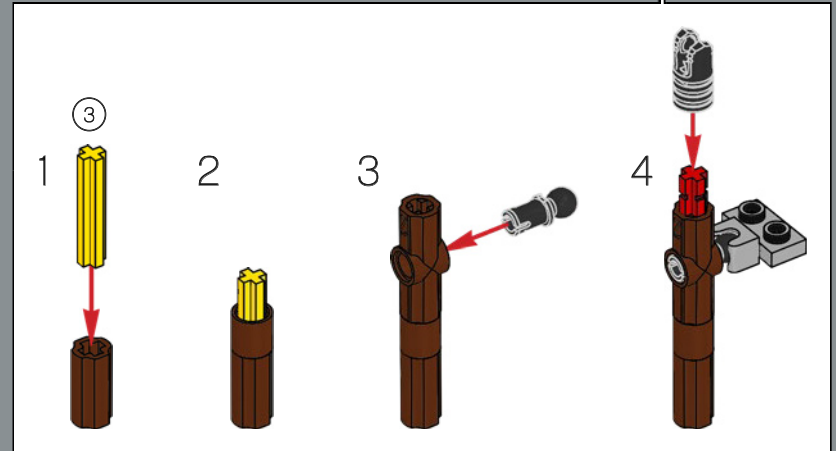

137

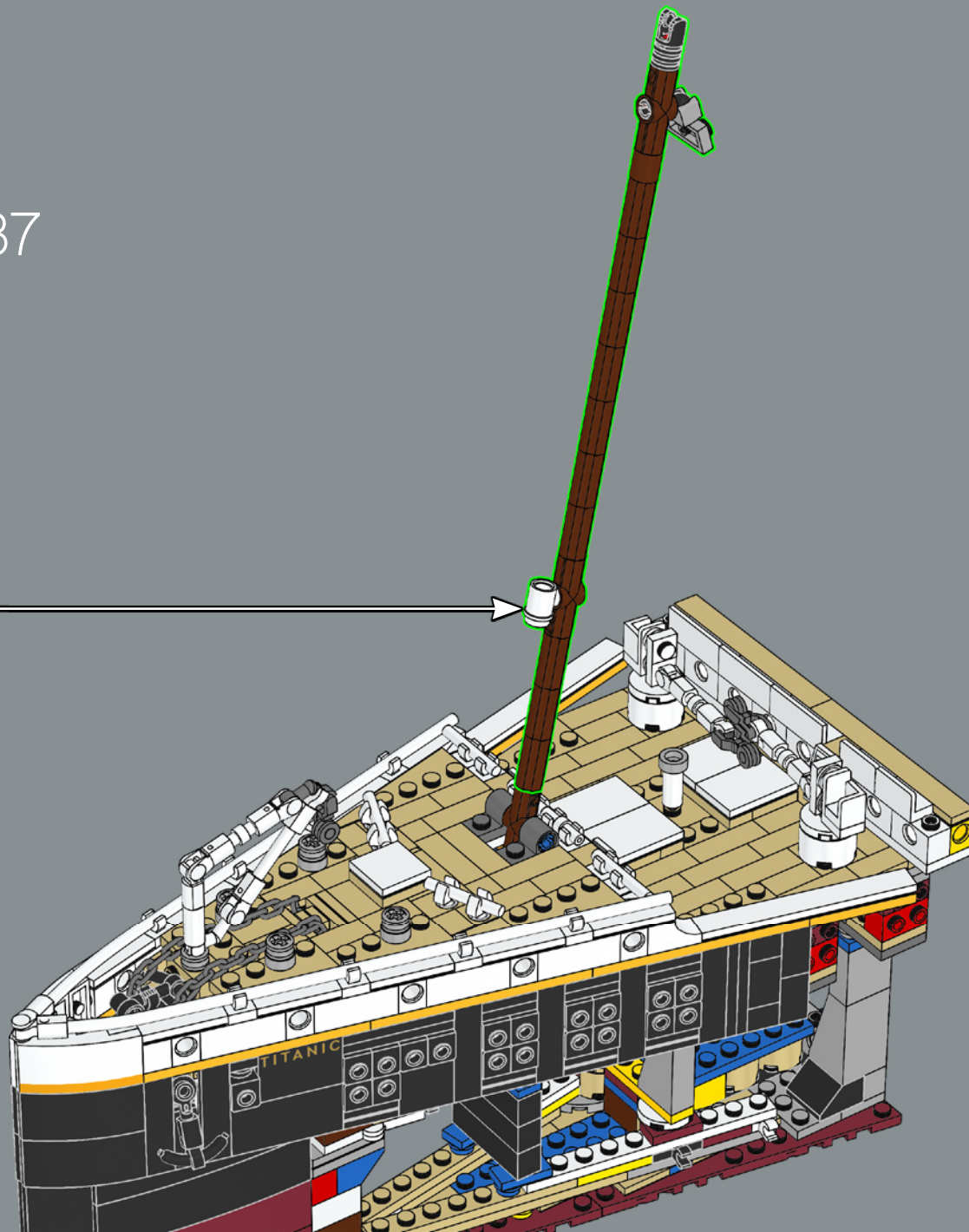

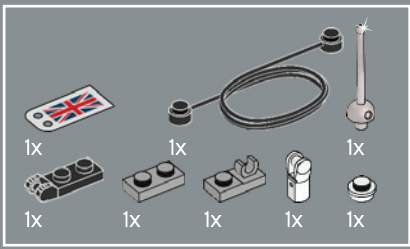

138

1

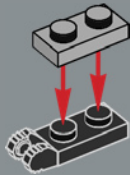

2

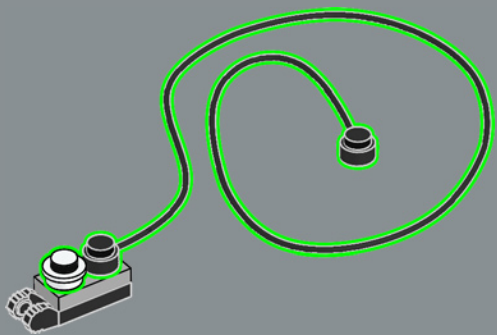

3

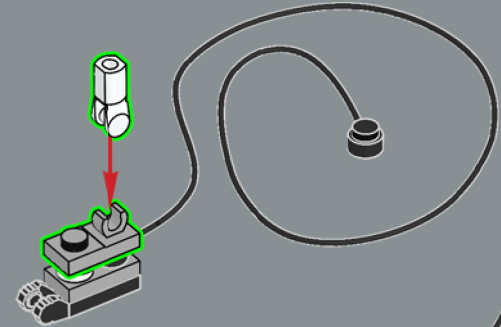

4

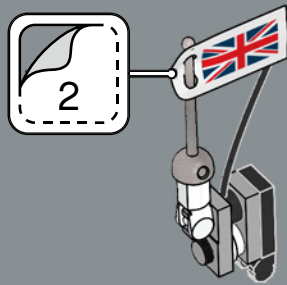

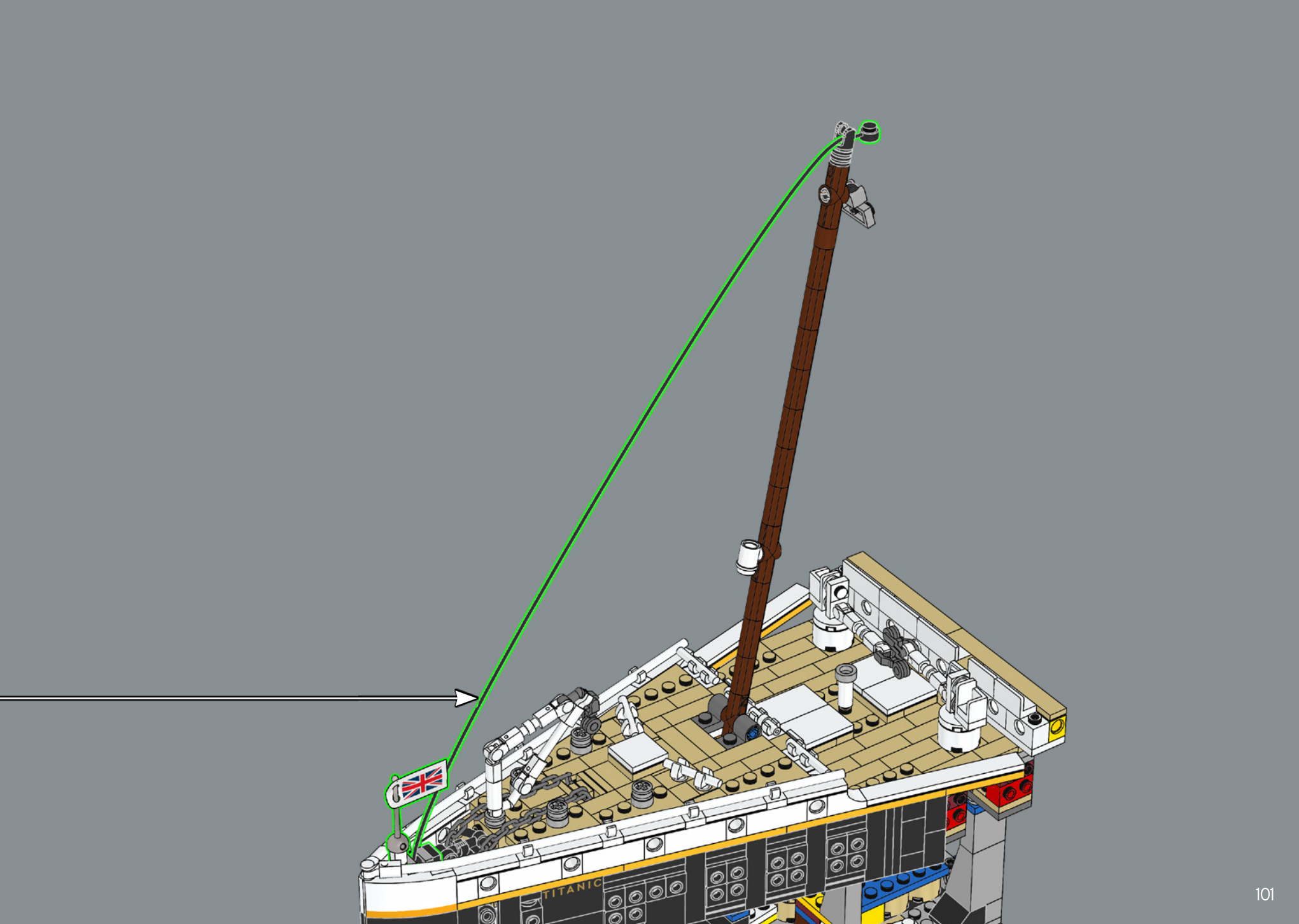

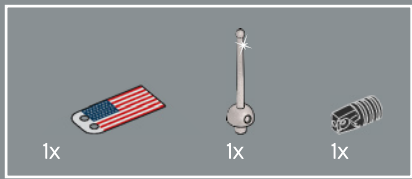

139

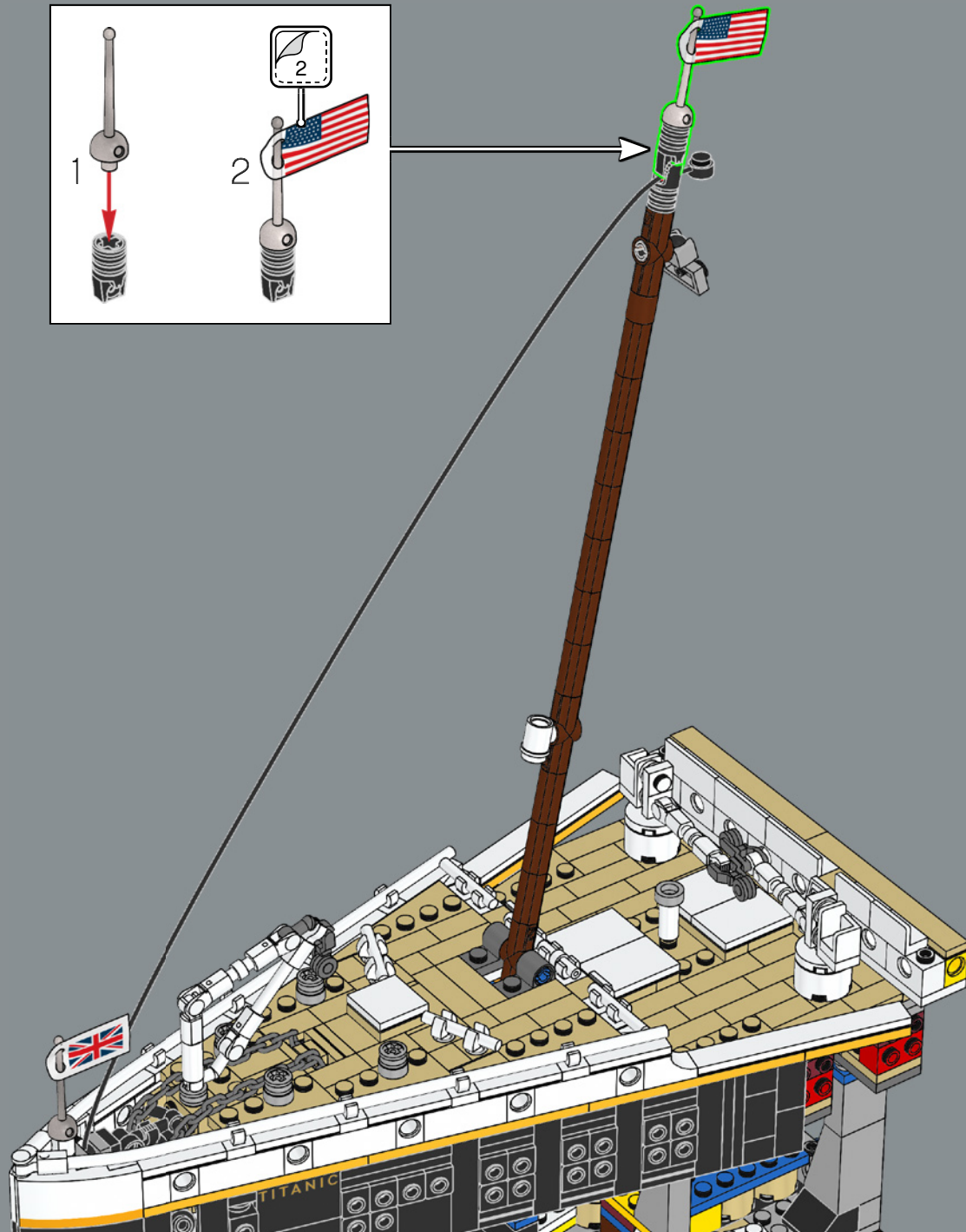
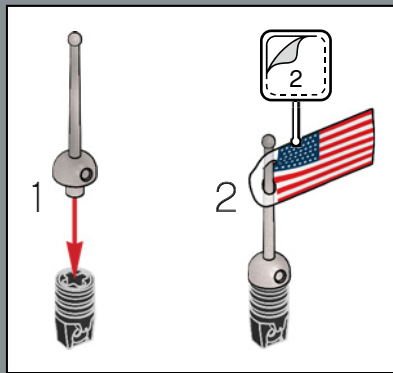

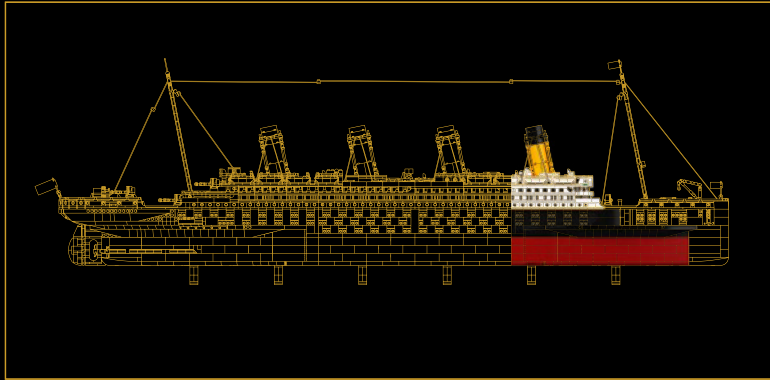

SECCIÓN 2:

PUENTE Y CHIMENEA

En esta segunda sección, el casco presenta su máxima anchura (18 módulos o, aproximadamente, 144 mm). Dentro del casco, empezarás a construir la sección transversal del barco, incluidas parte de la piscina, la Gran Escalera y una de las salas de calderas del *Titanic*. También construirás la emblemática caseta del puente y la primera de las cuatro chimeneas.

↓ El mecanismo de fijación oculto en el interior de la Gran Escalera permite conectar firmemente todo el barco.



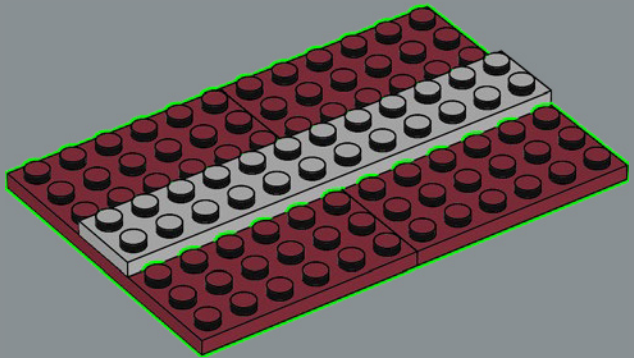
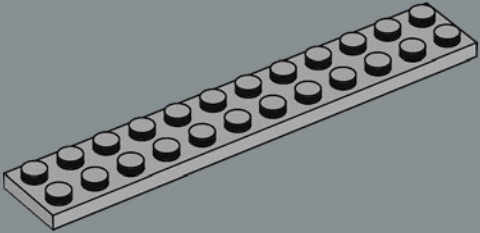
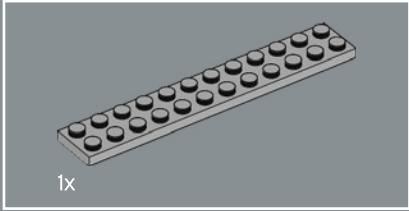
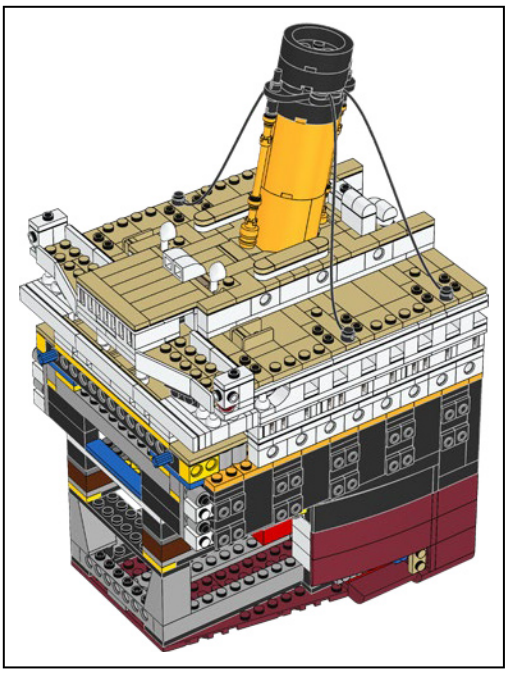
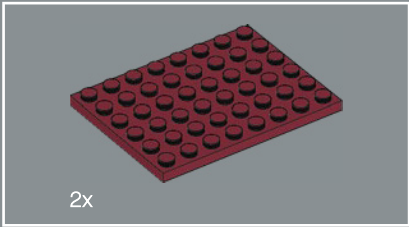
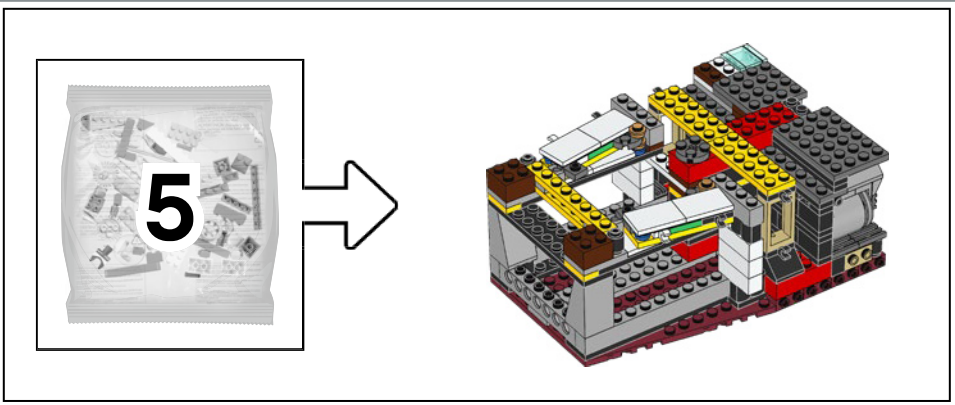

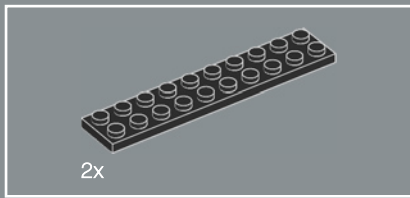

142

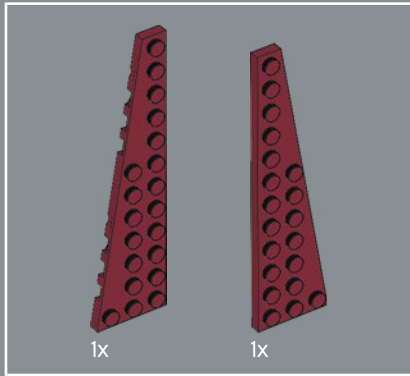
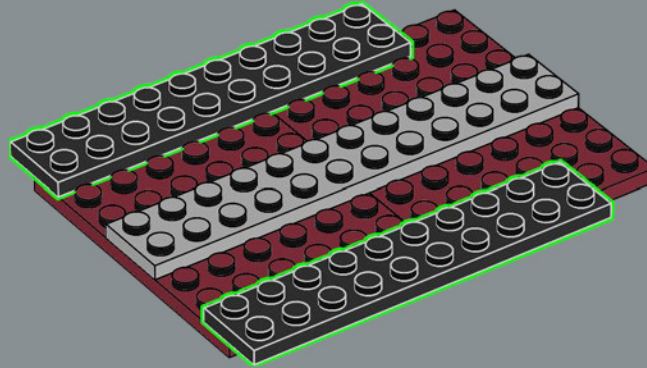

143

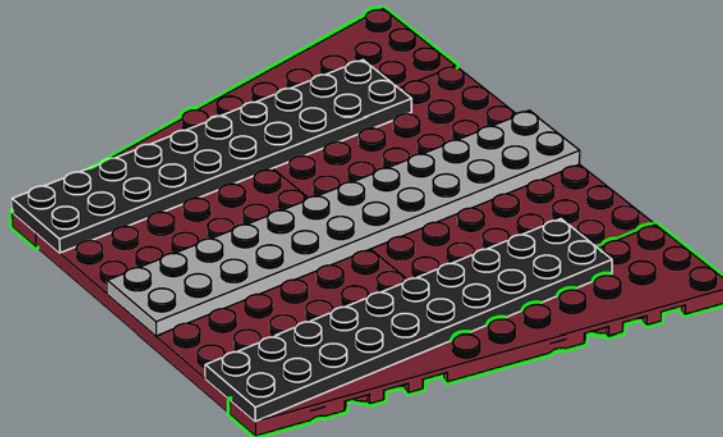

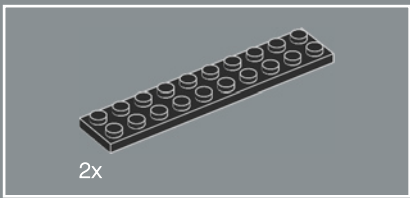

144

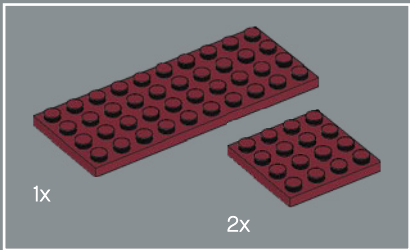
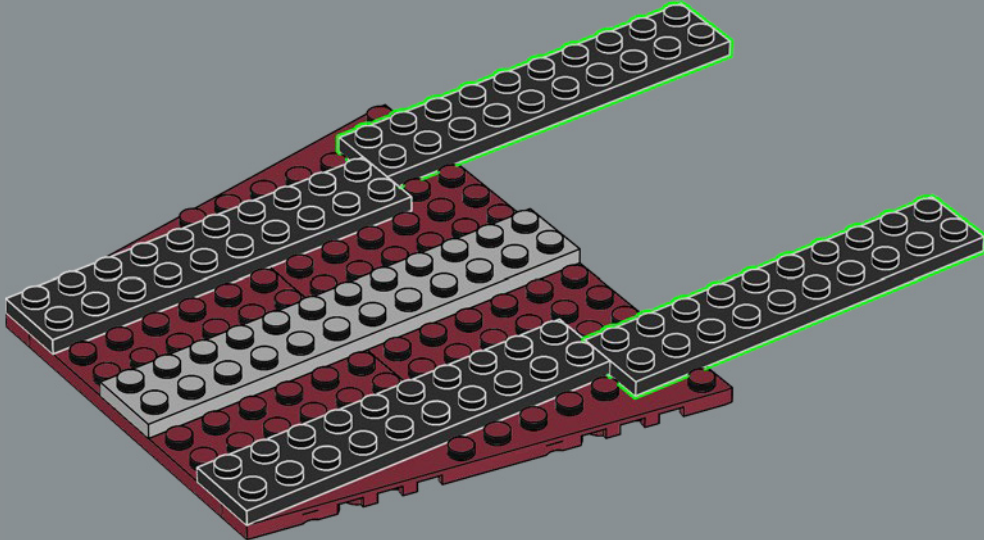

145

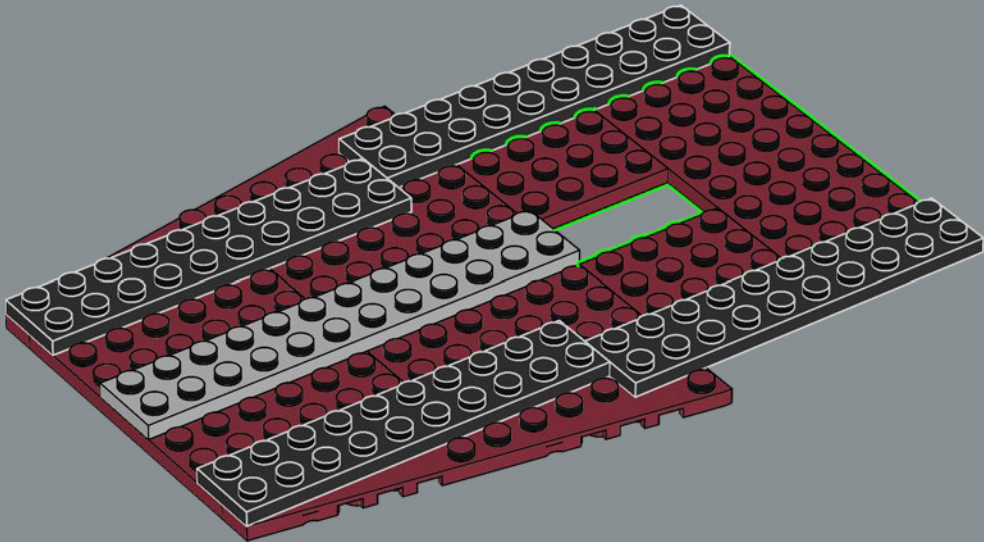

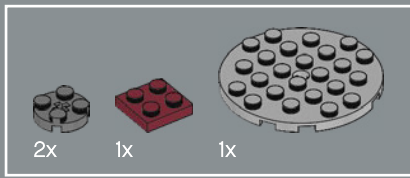

146

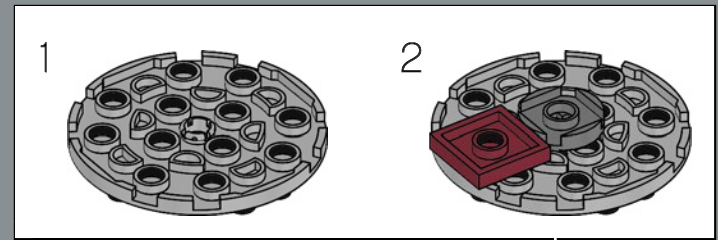
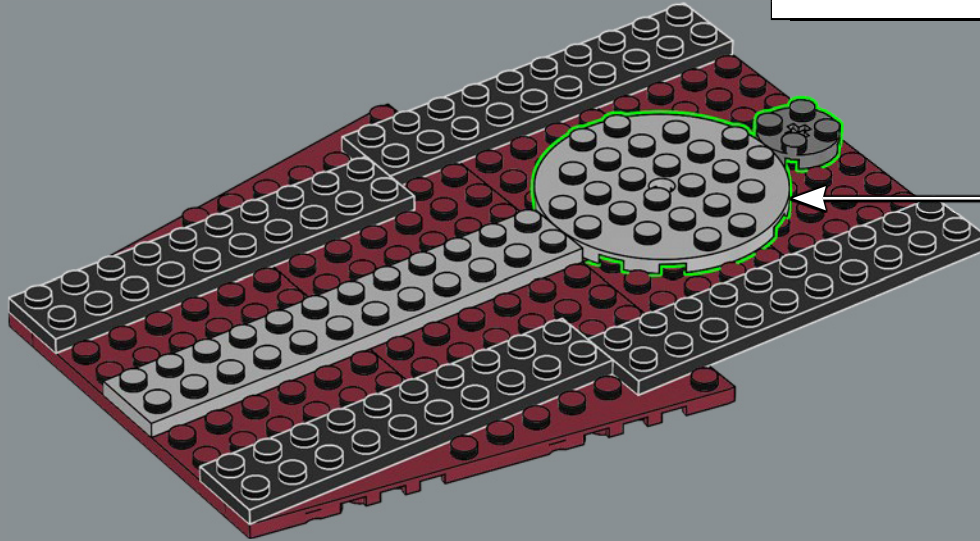

147

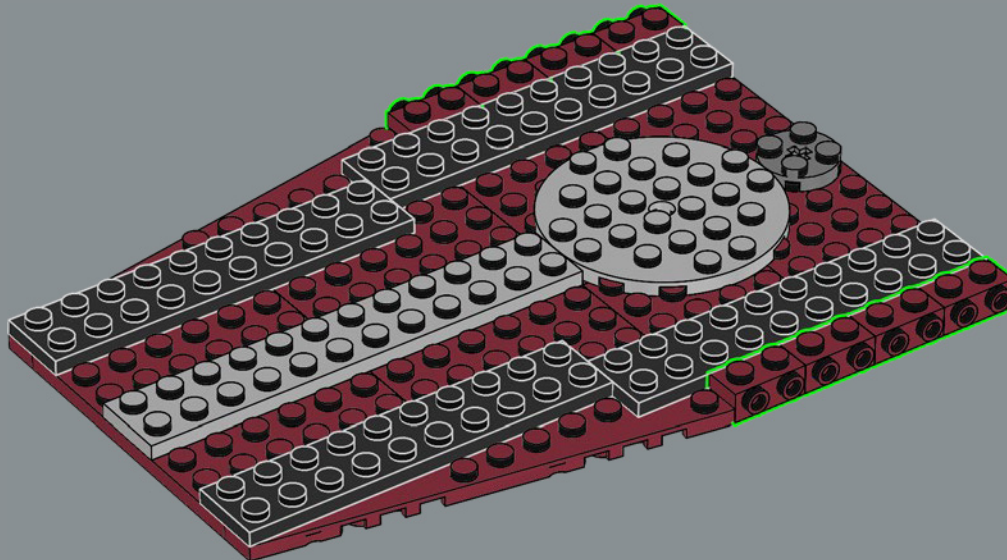

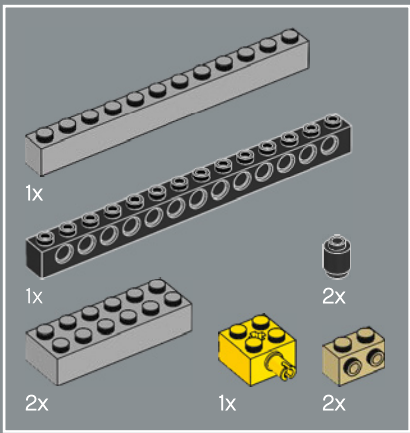

148

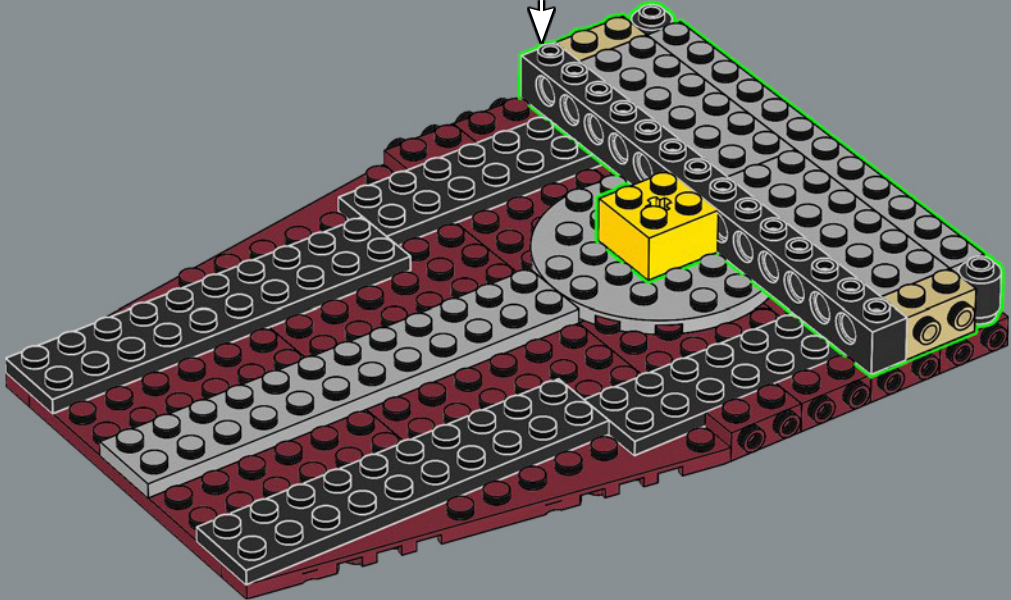
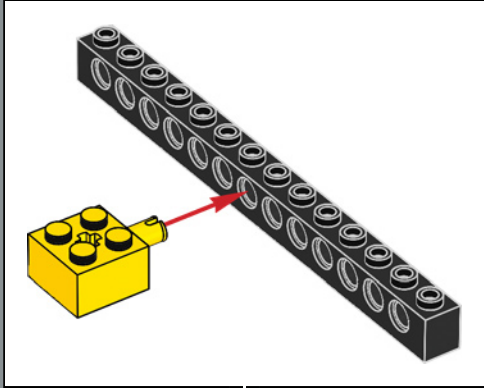

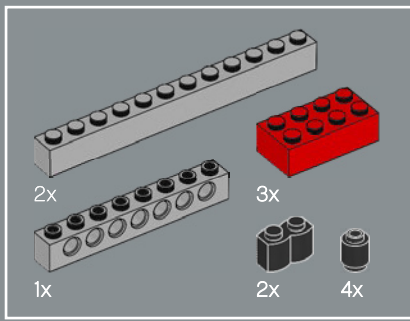

149

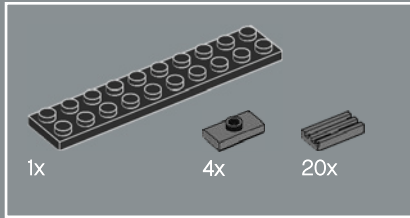
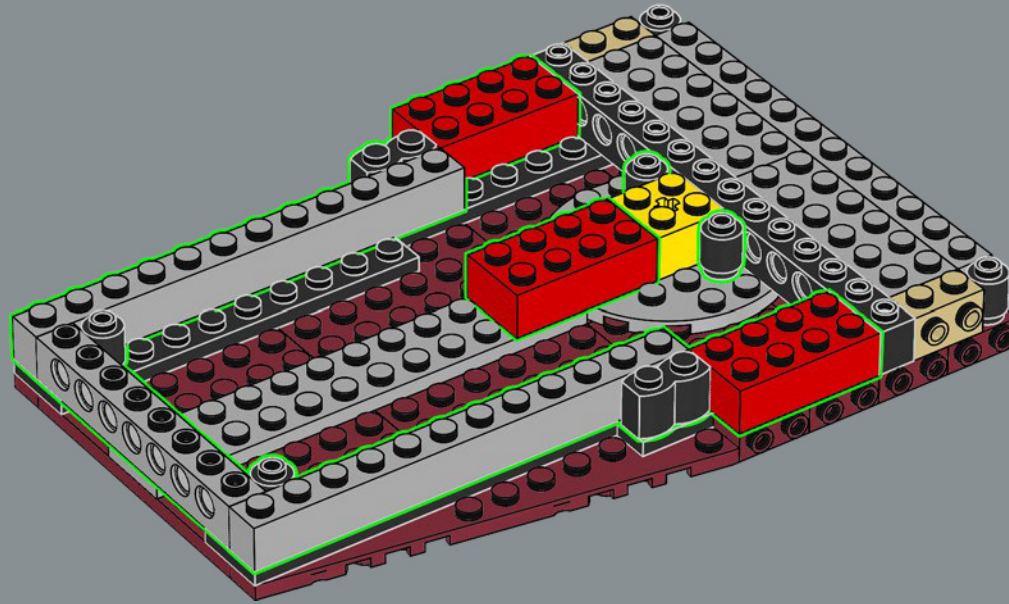

150

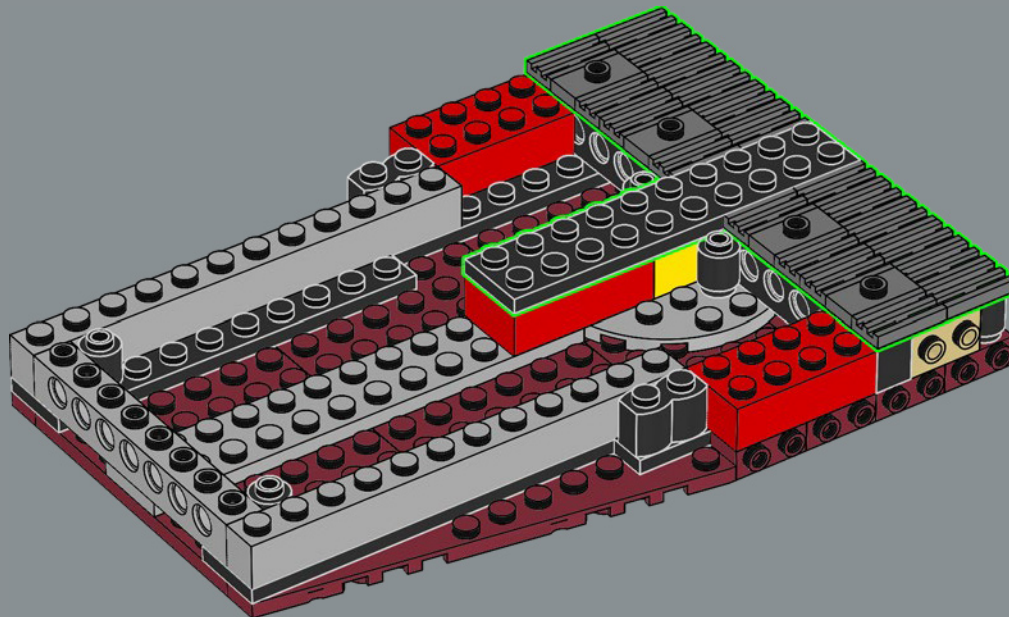

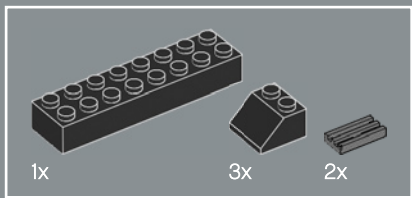

151

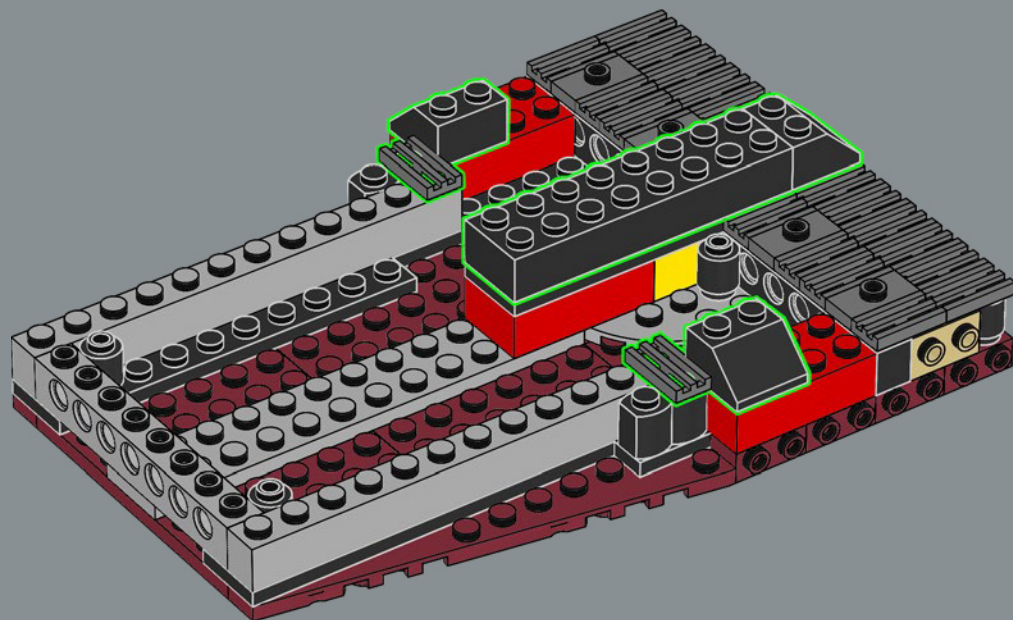

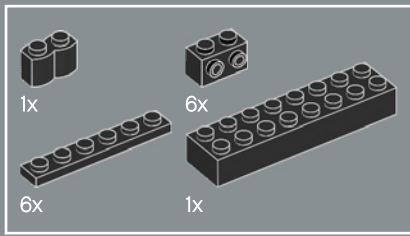

152

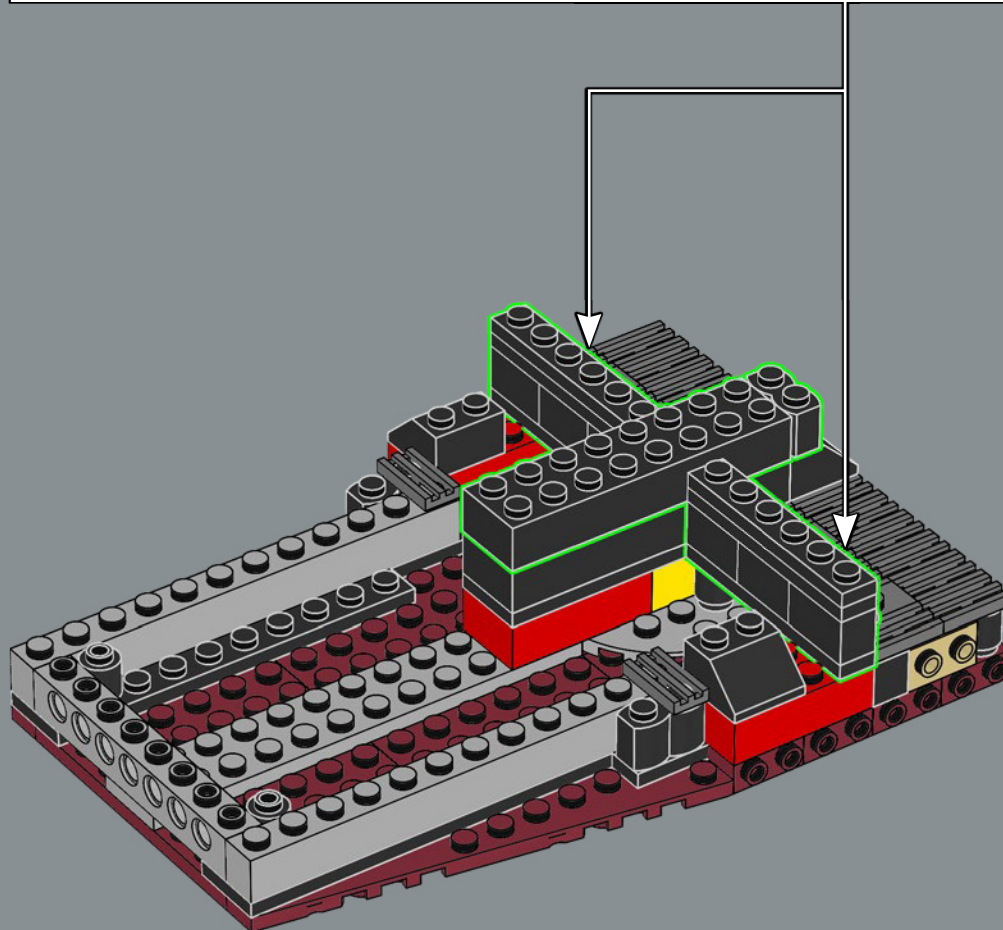
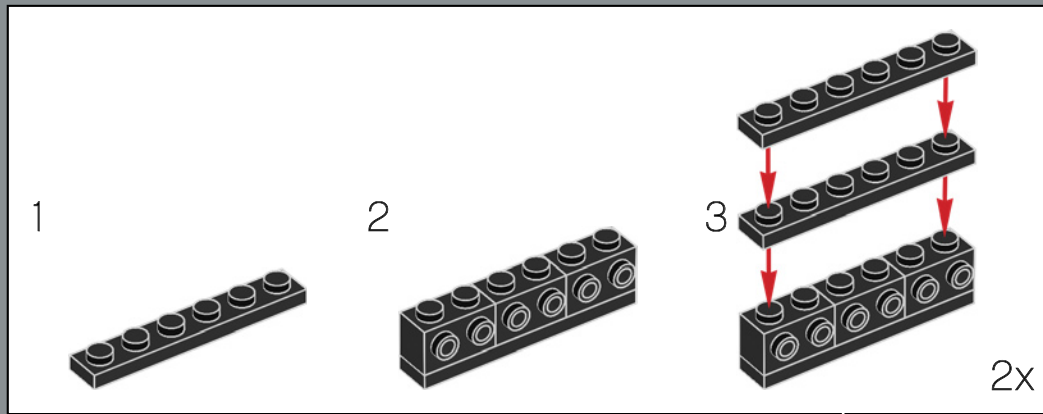

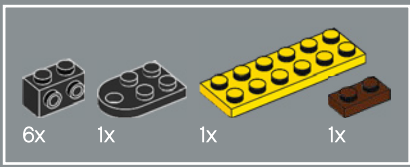

153

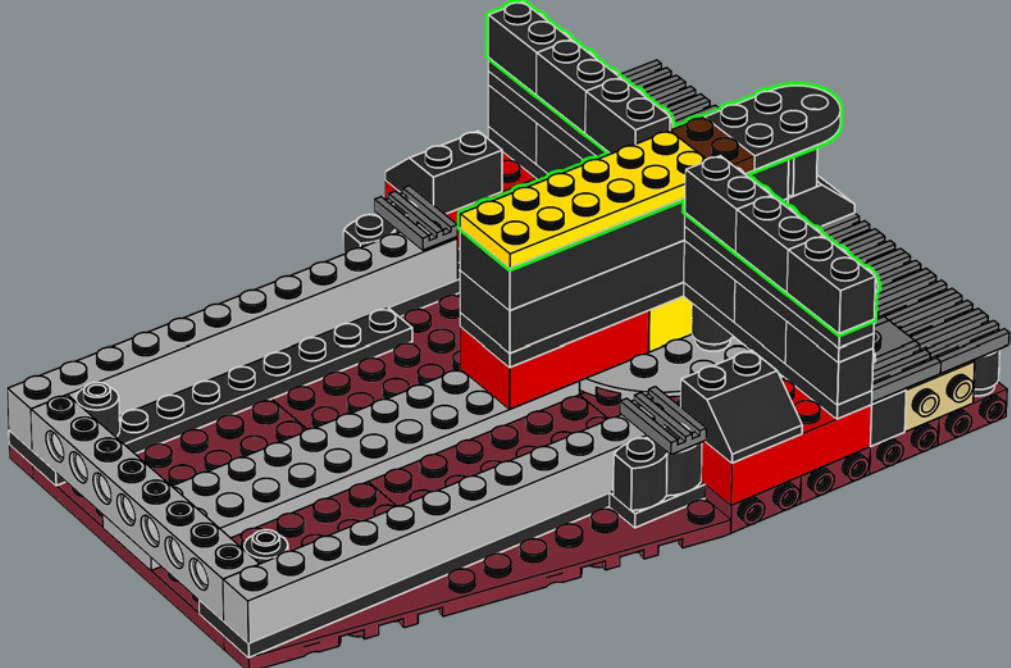

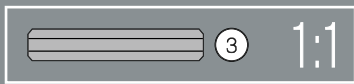
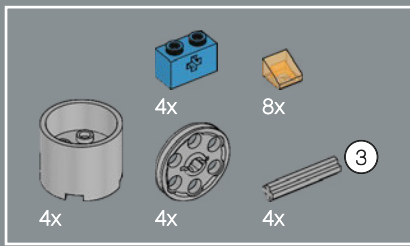

154

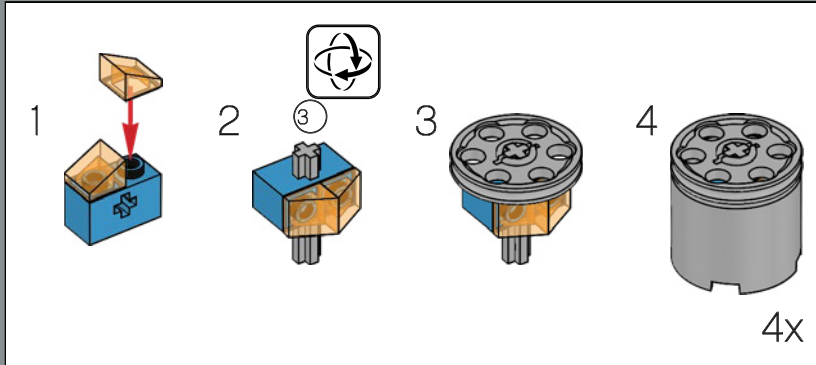

175 fogoneros trabajaban día y noche paleando carbón a las calderas de los motores.

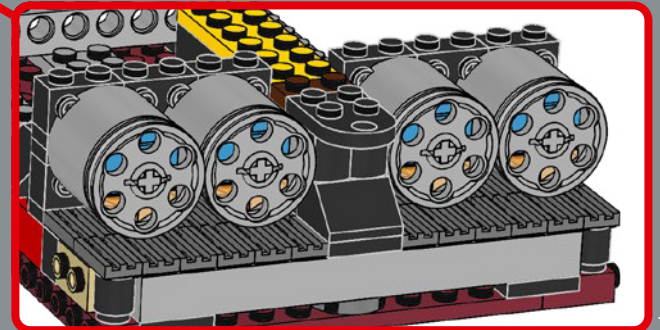
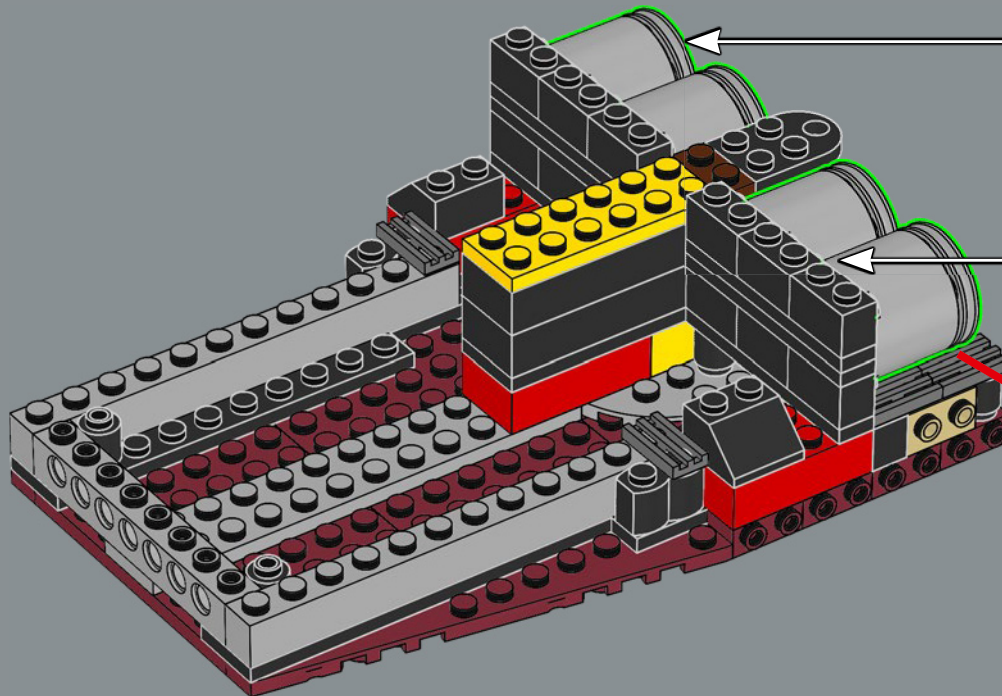

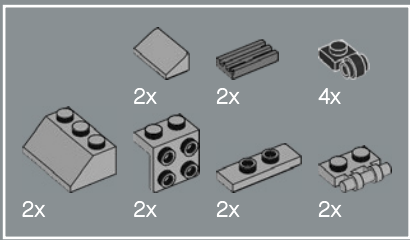

155

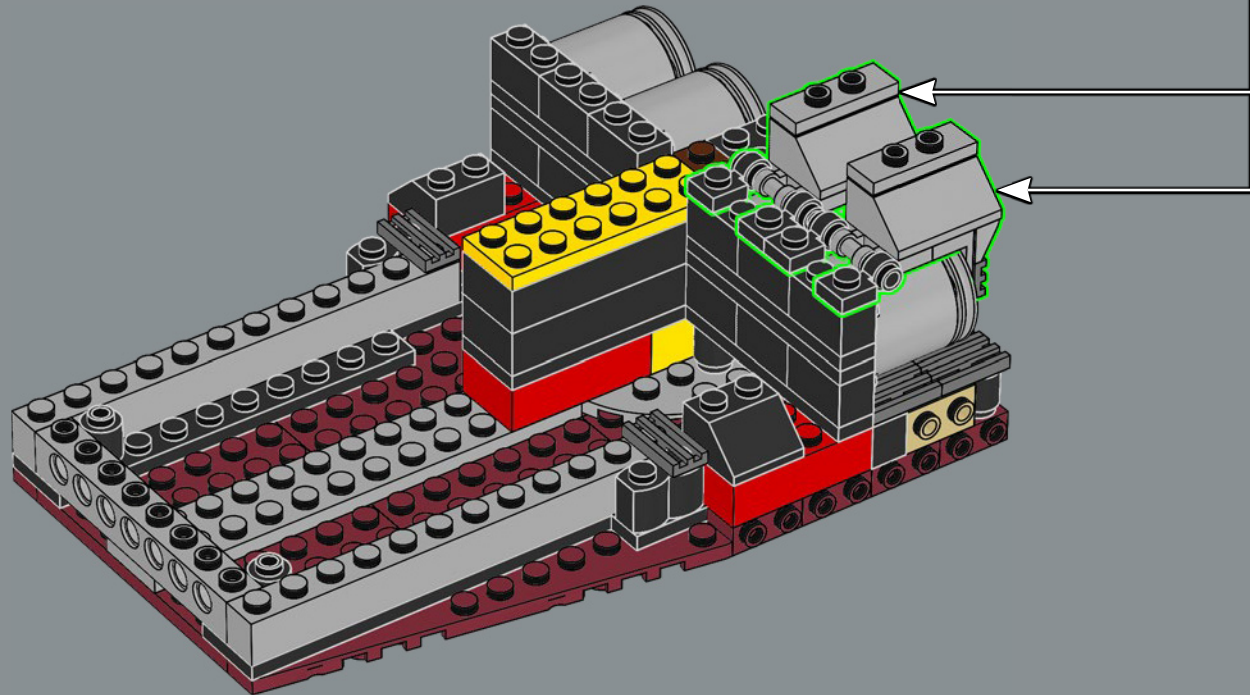
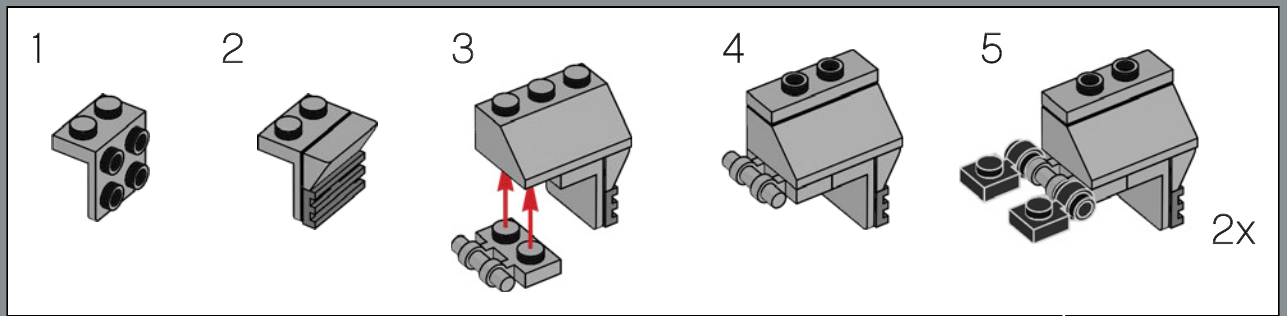

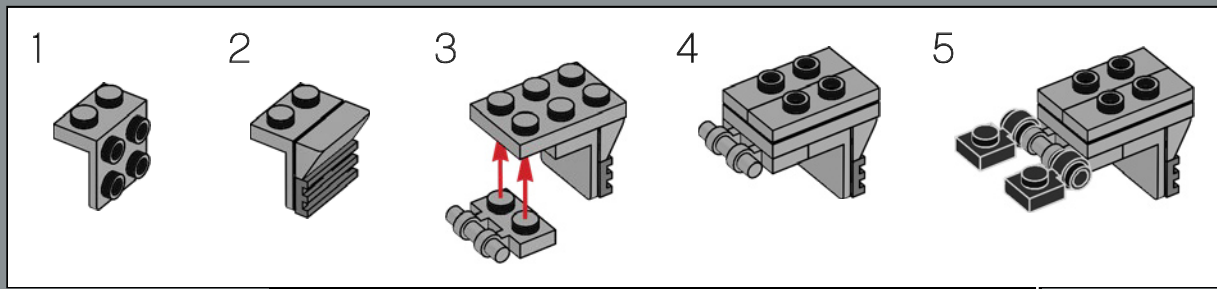
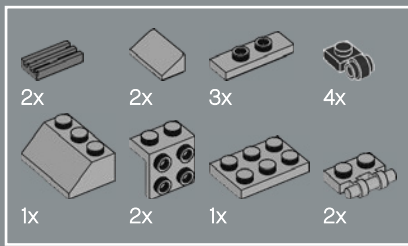

156

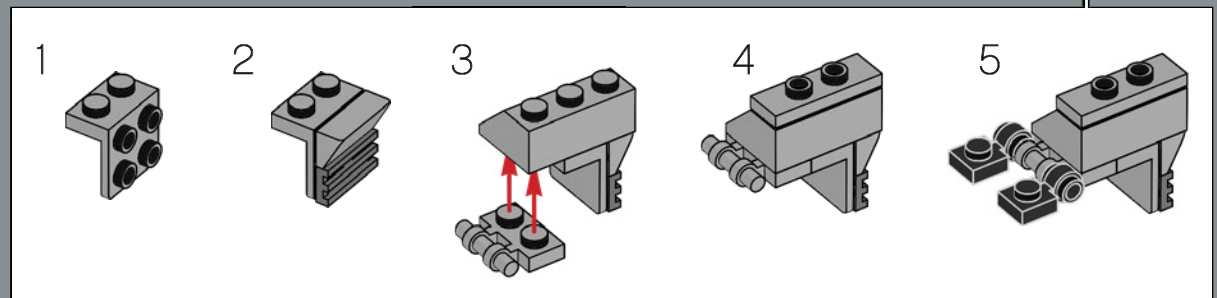
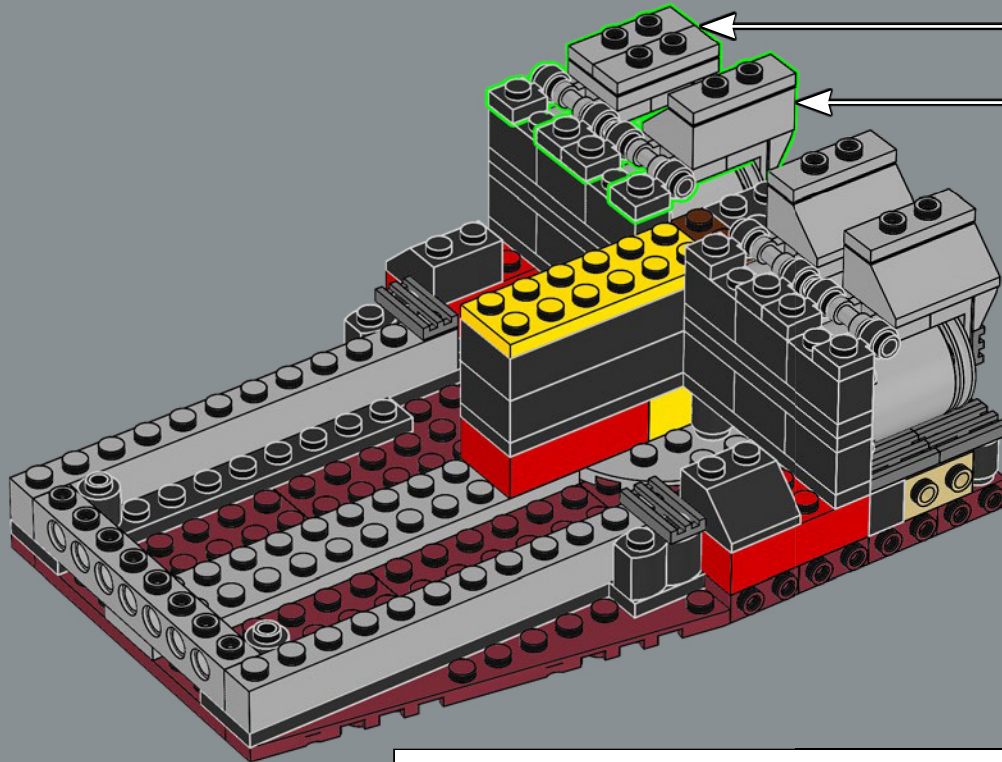

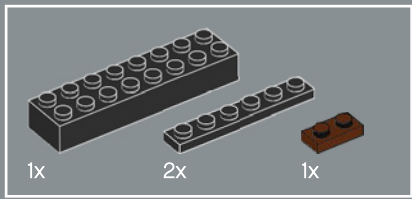

157

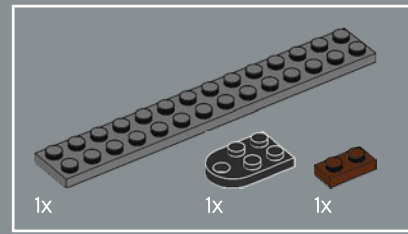
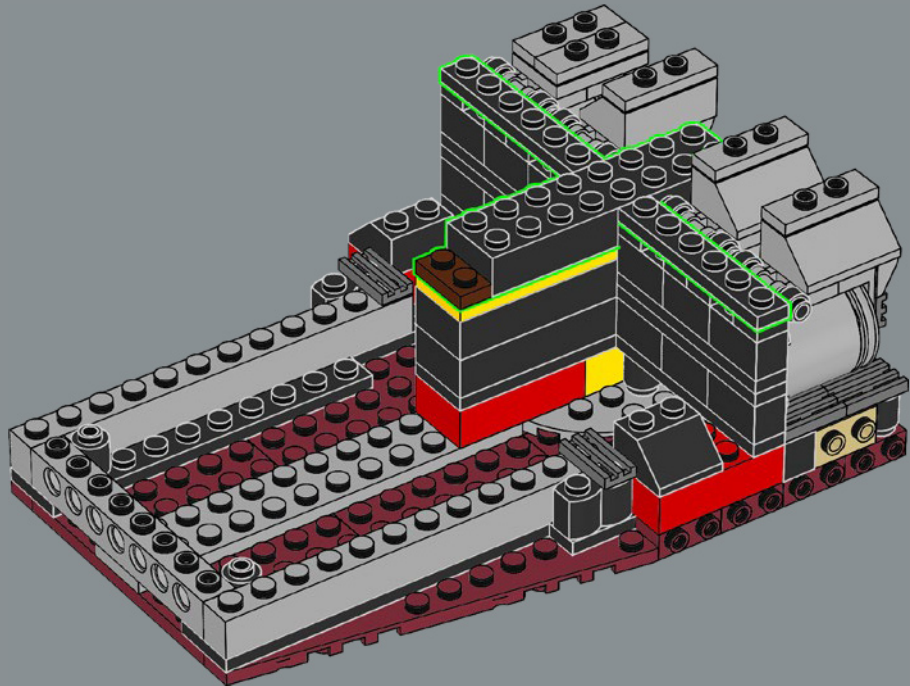

158

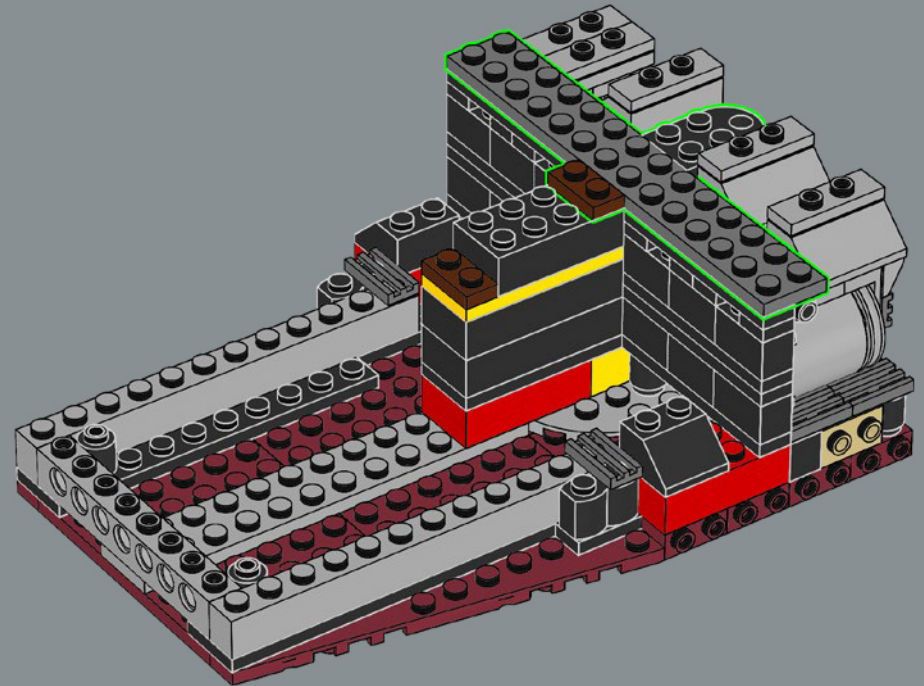

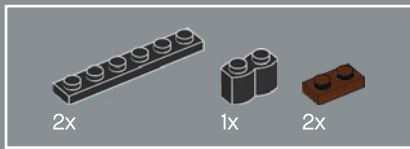

159

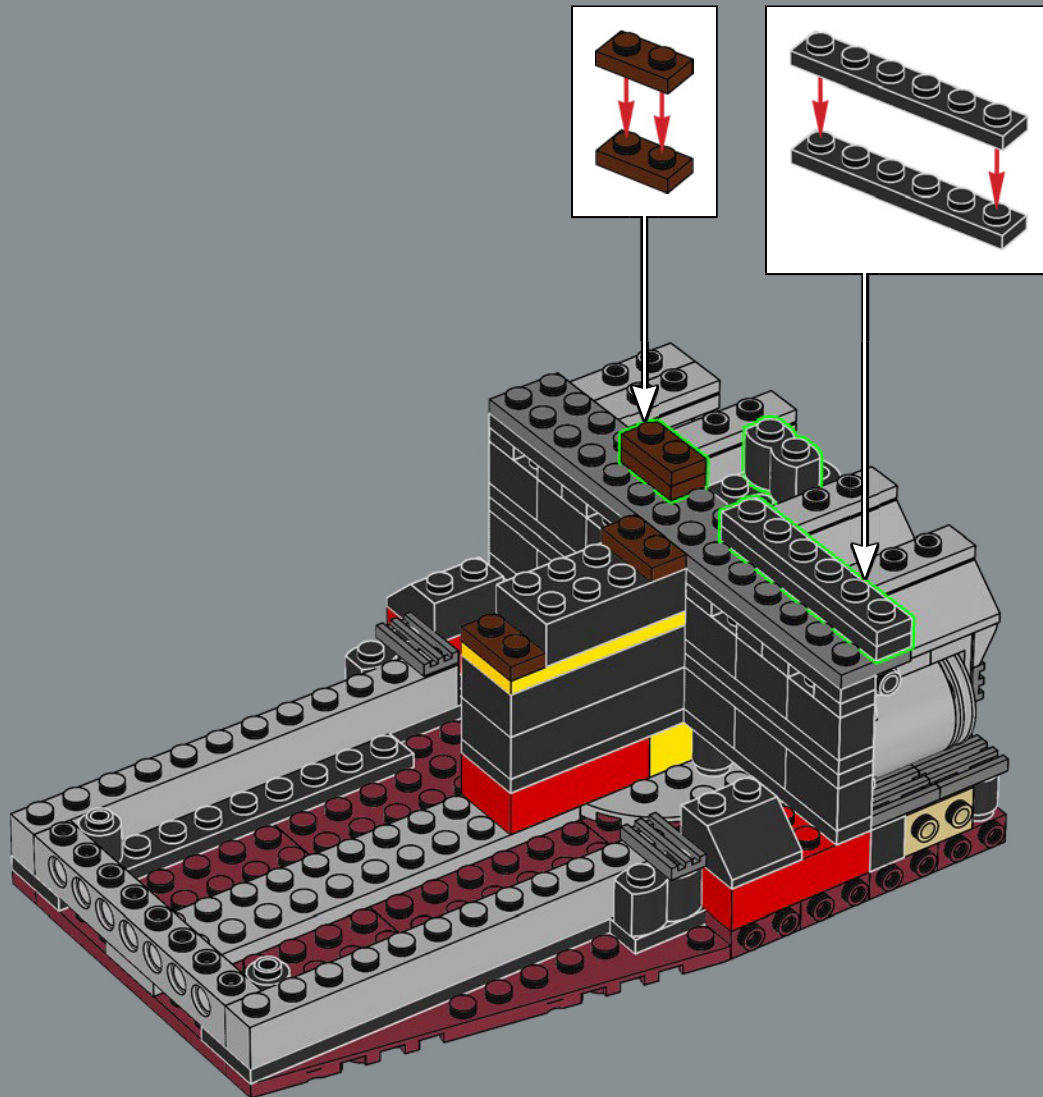

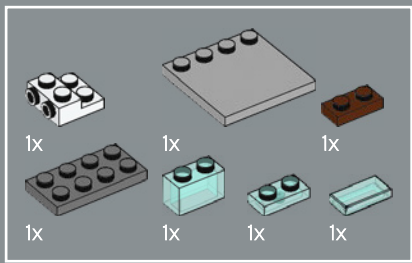

160

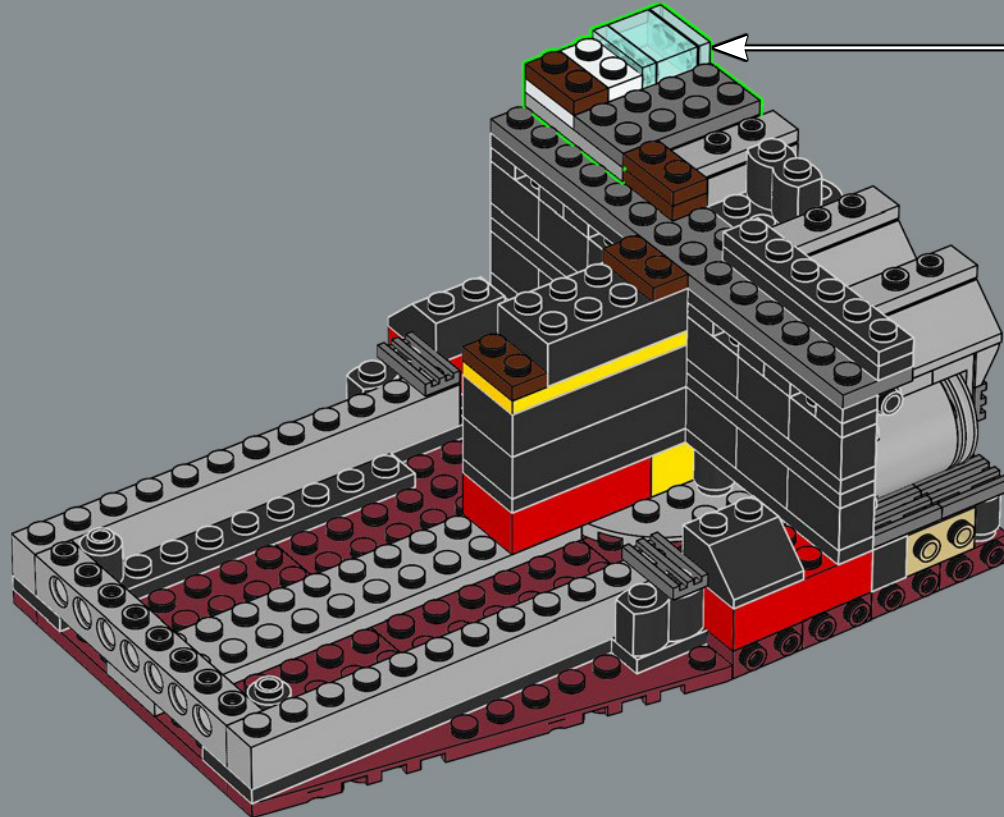
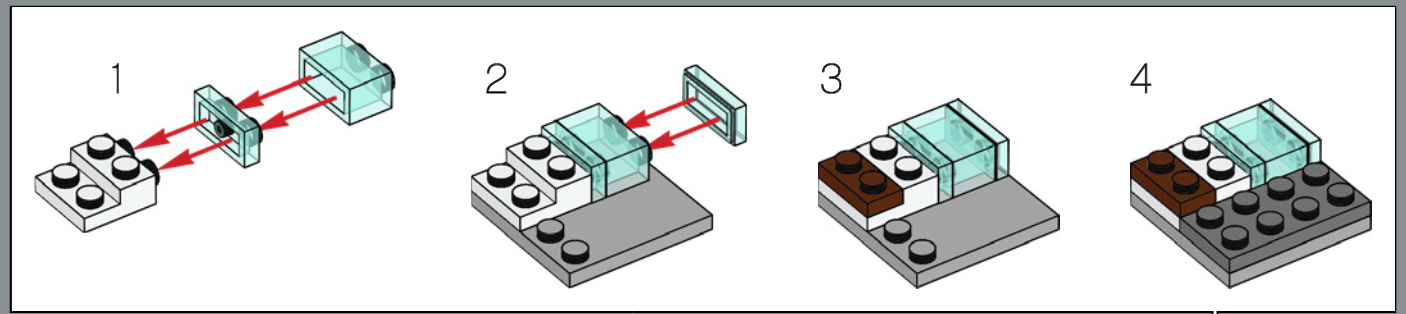

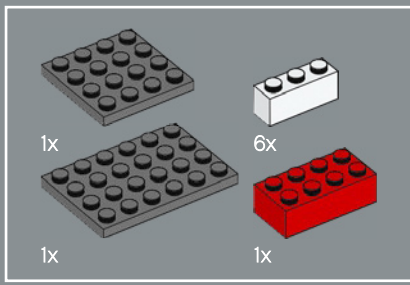

161

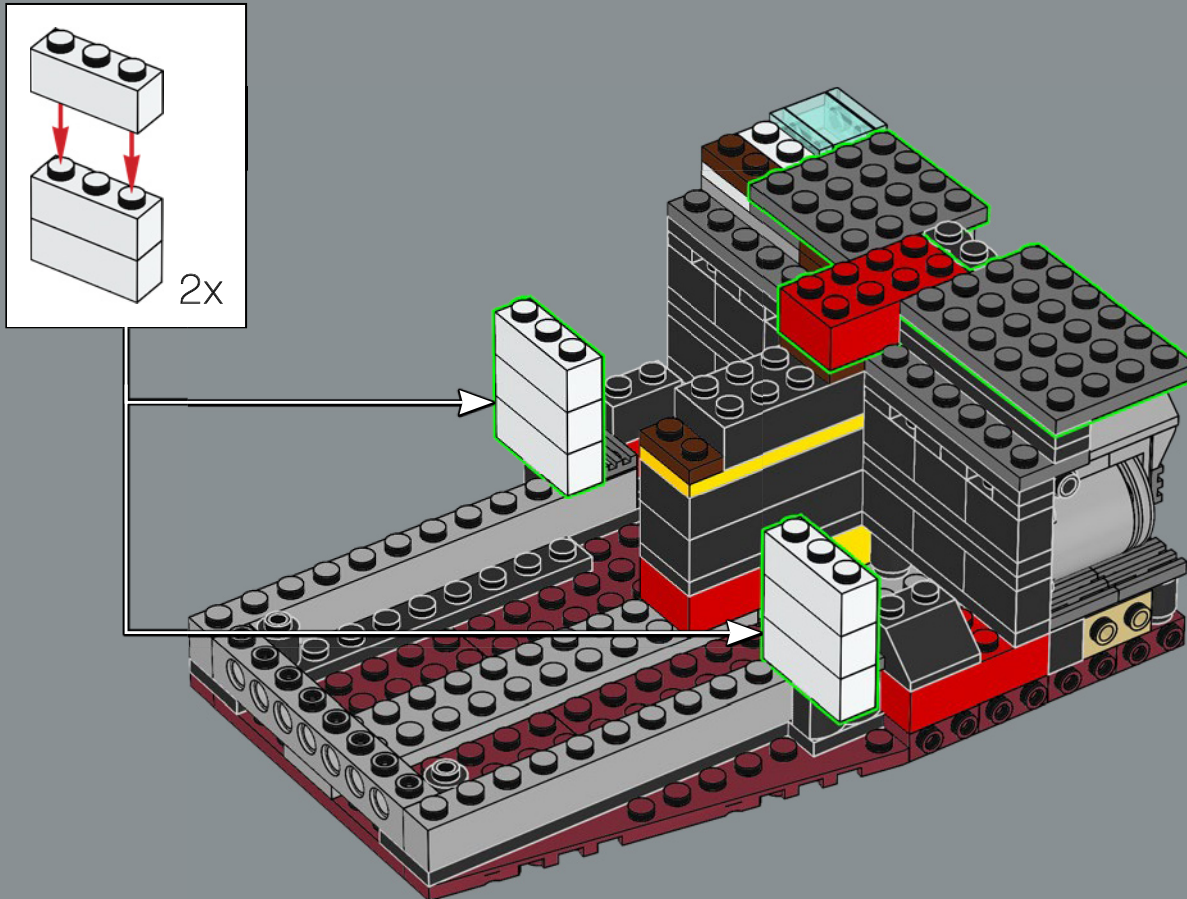

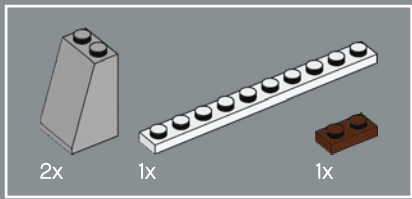

162

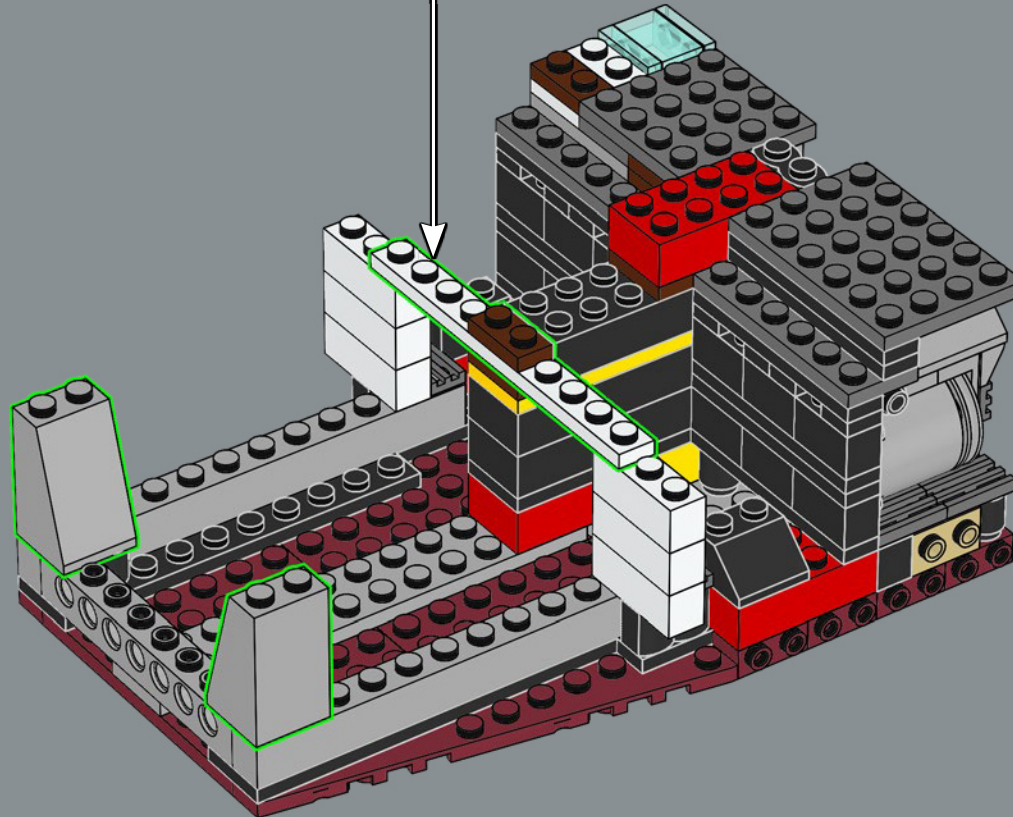
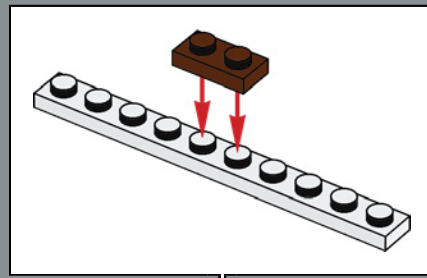

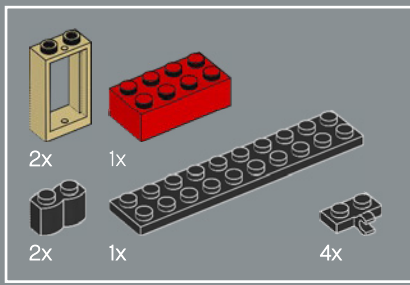

163

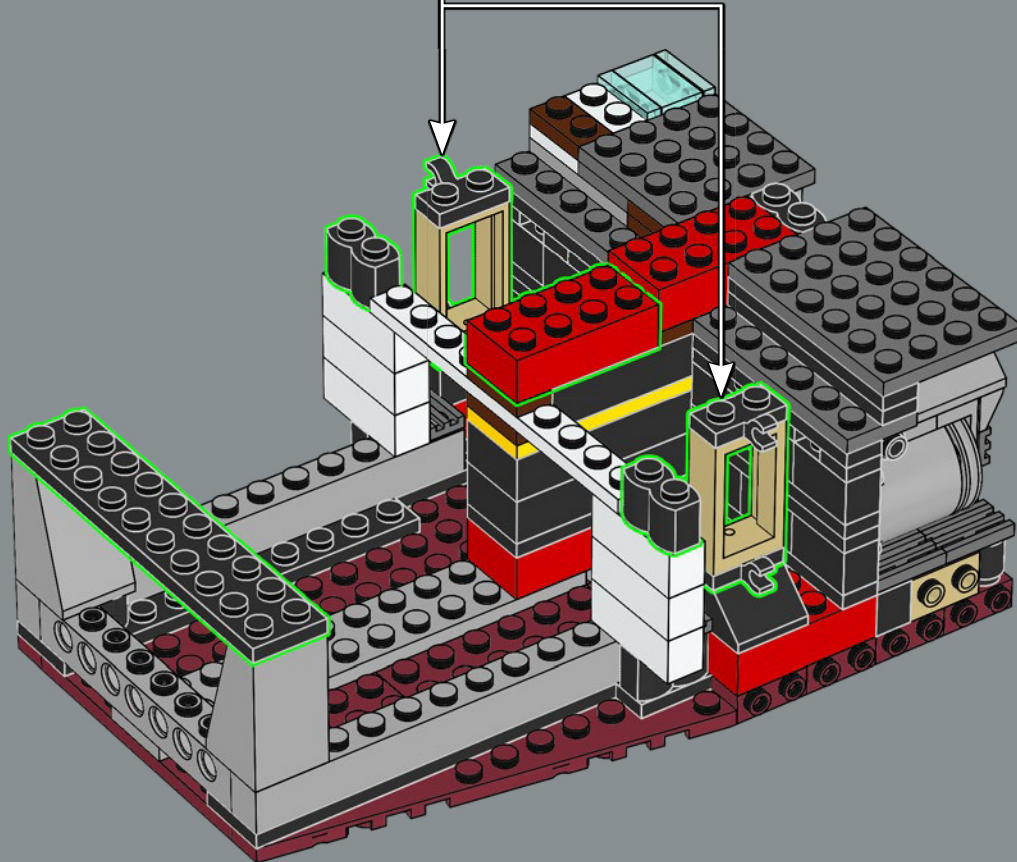
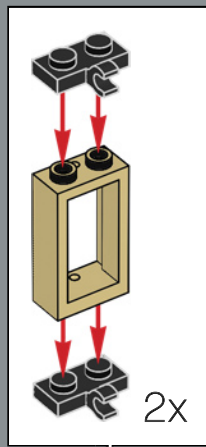

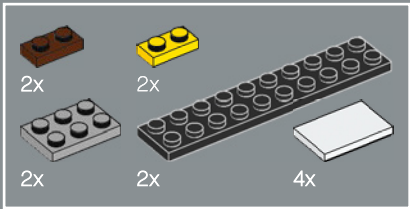

164

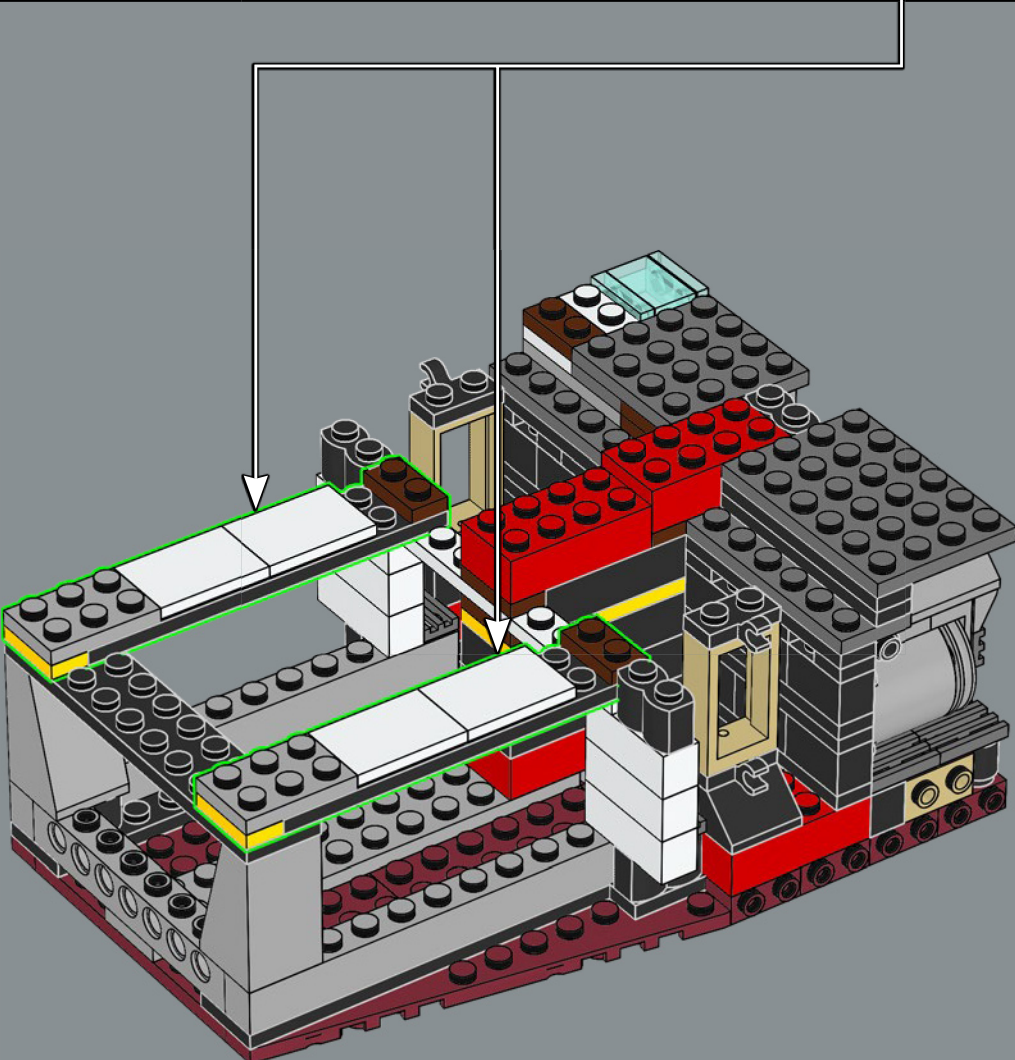
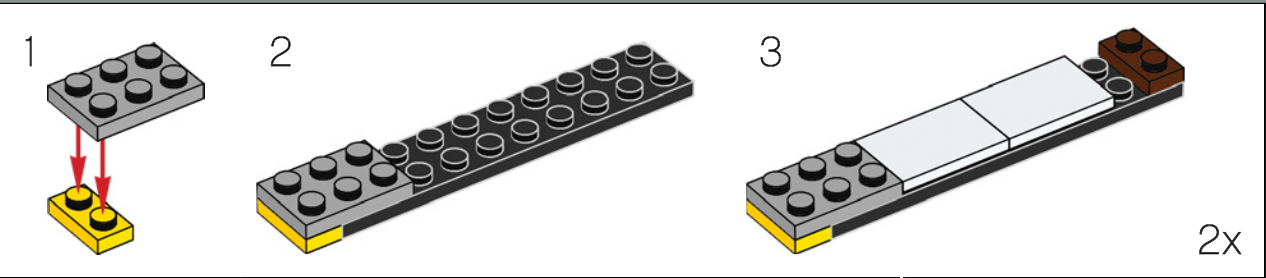

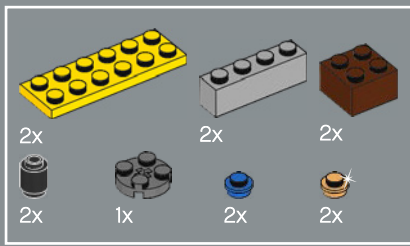

165

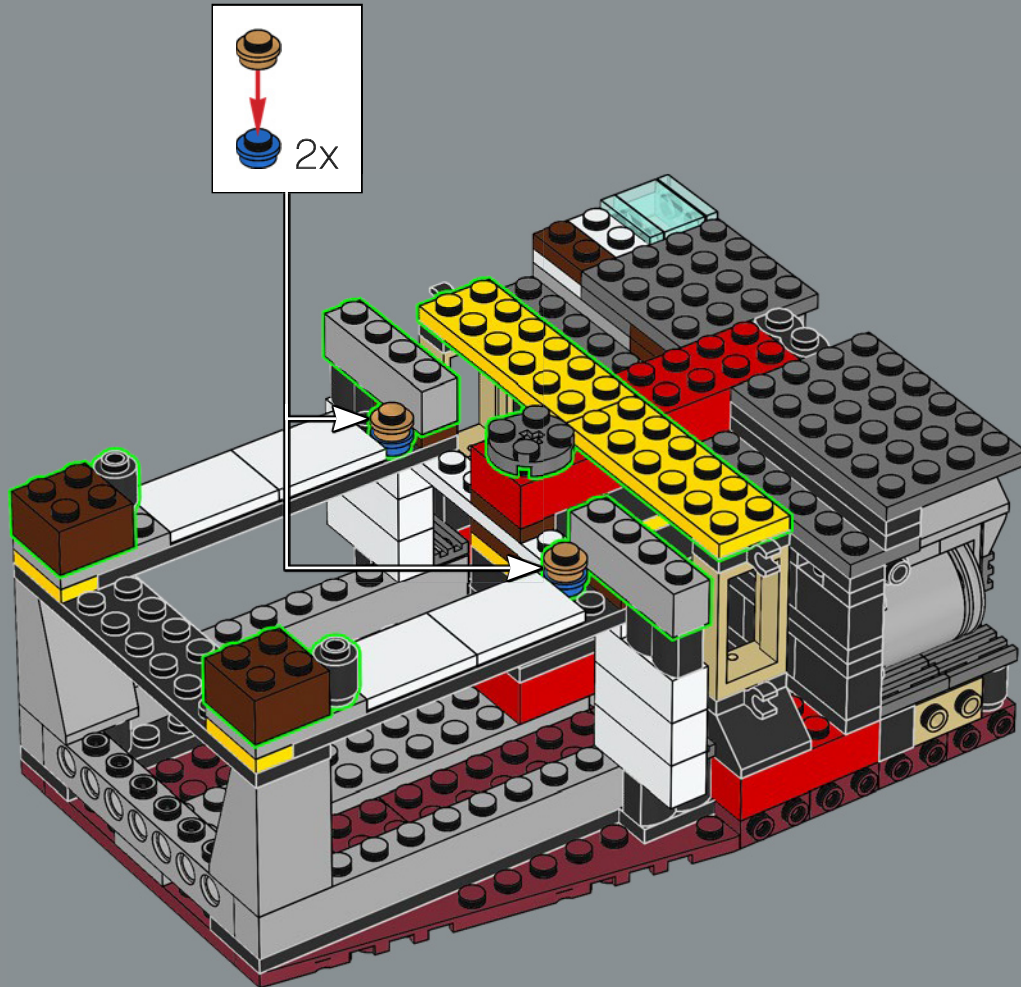

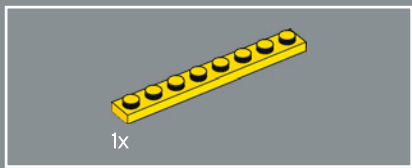

166

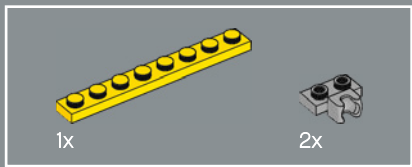
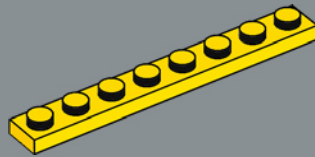

167

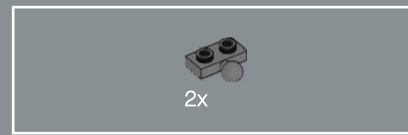
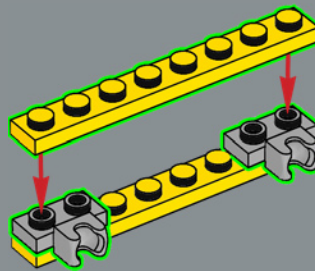

168

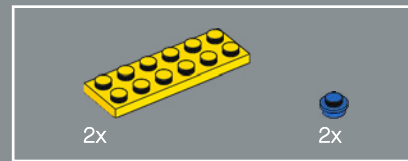
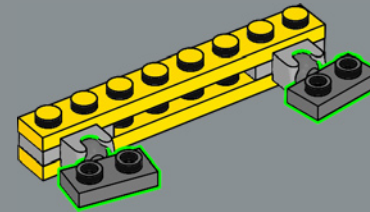

169

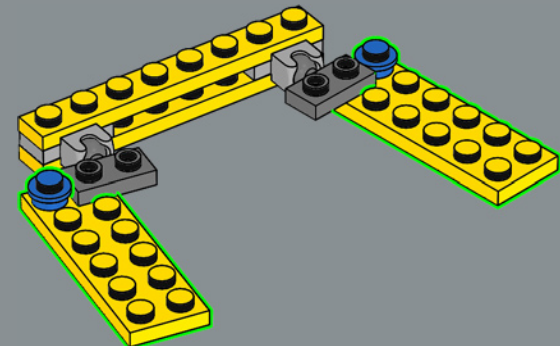

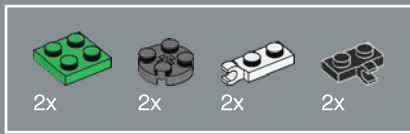

170

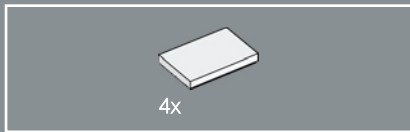
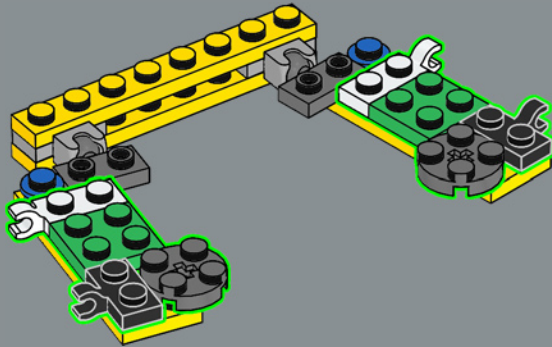

171

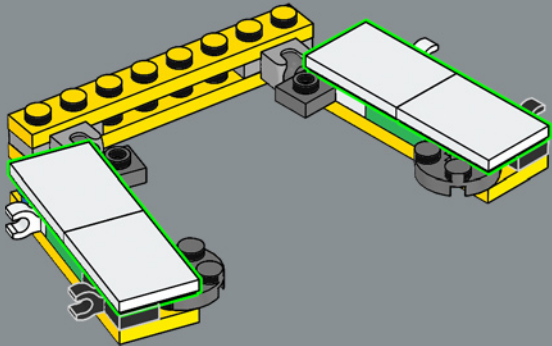

172

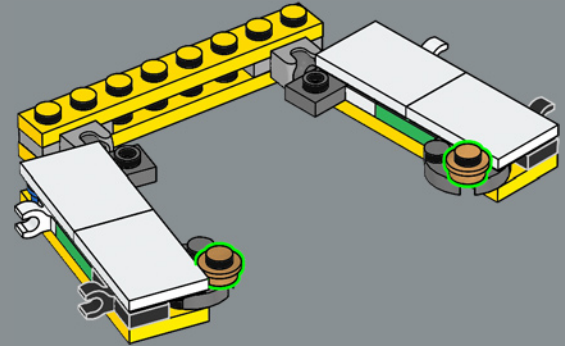

173

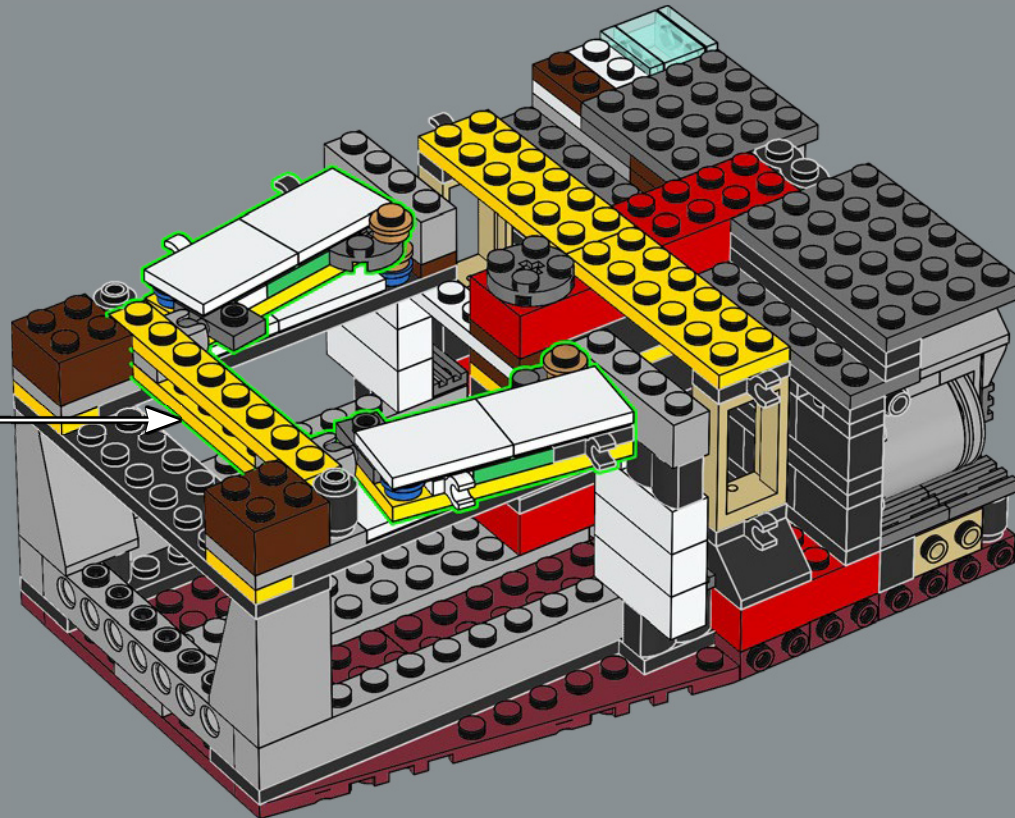

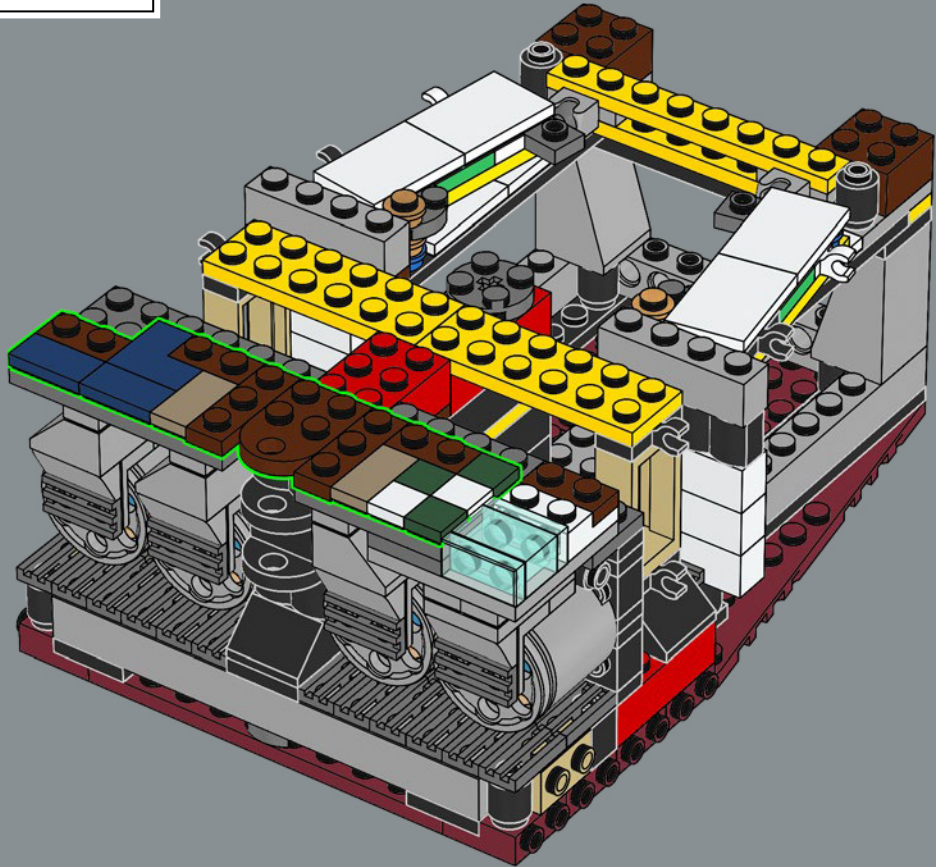
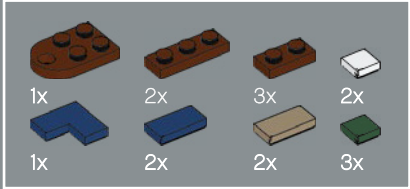
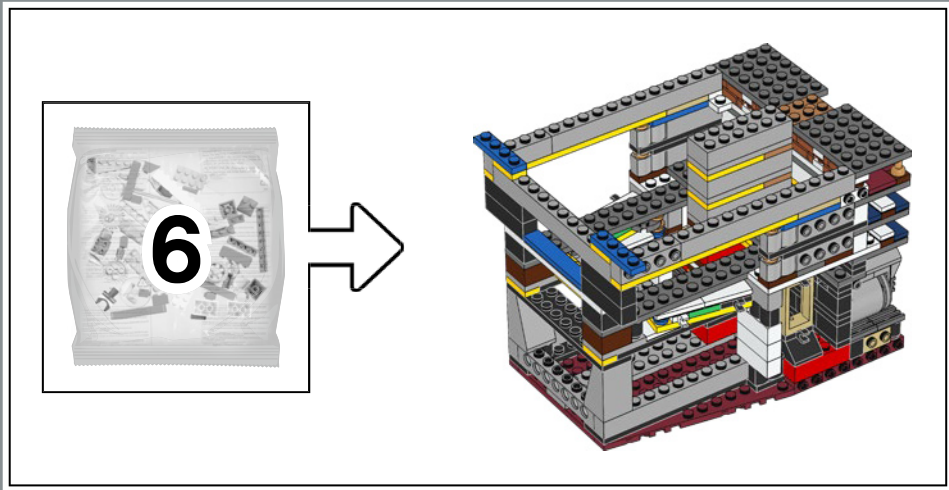

174

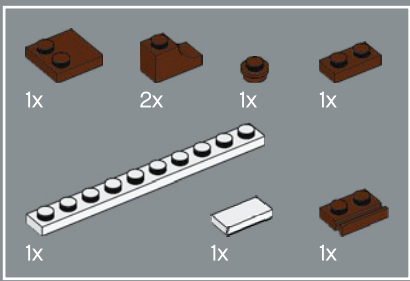

175

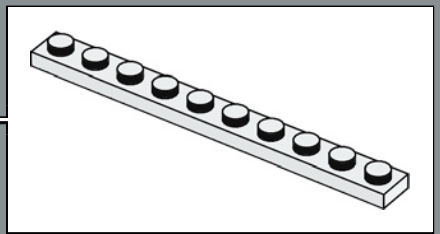
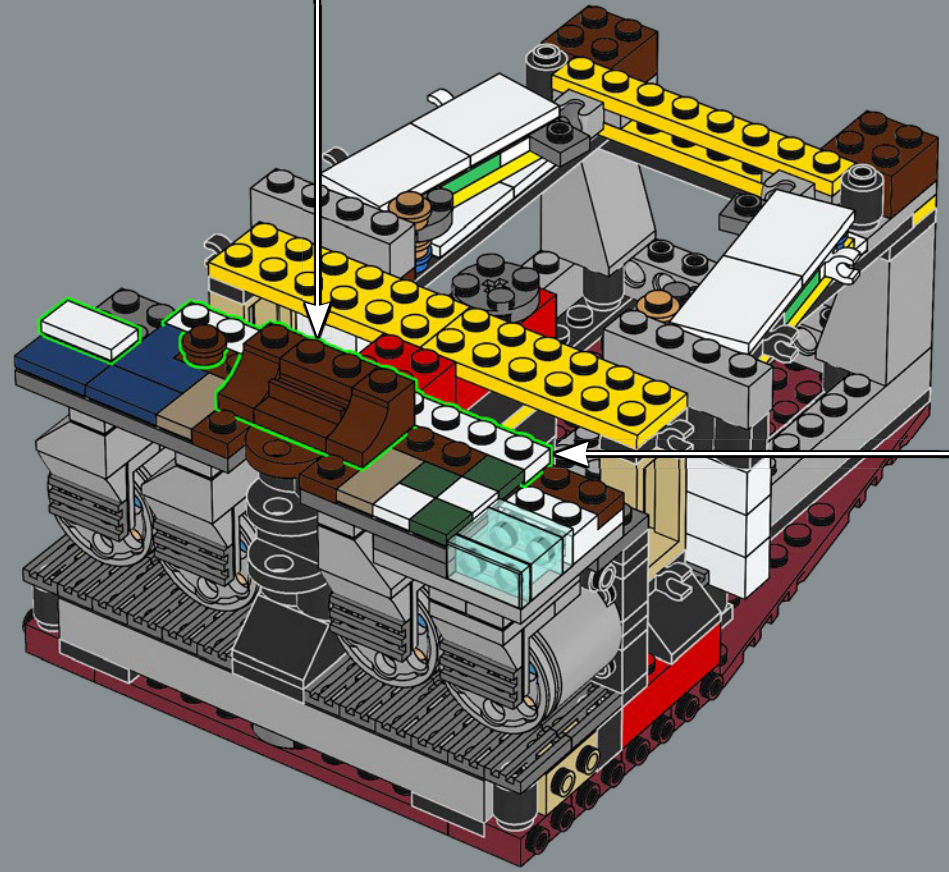
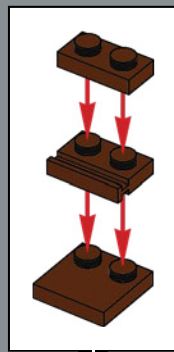

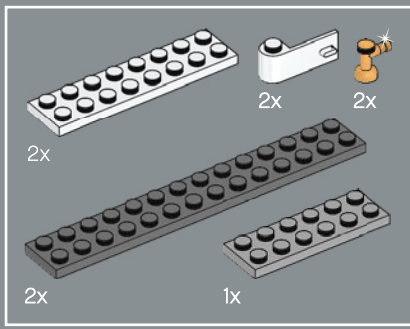

176

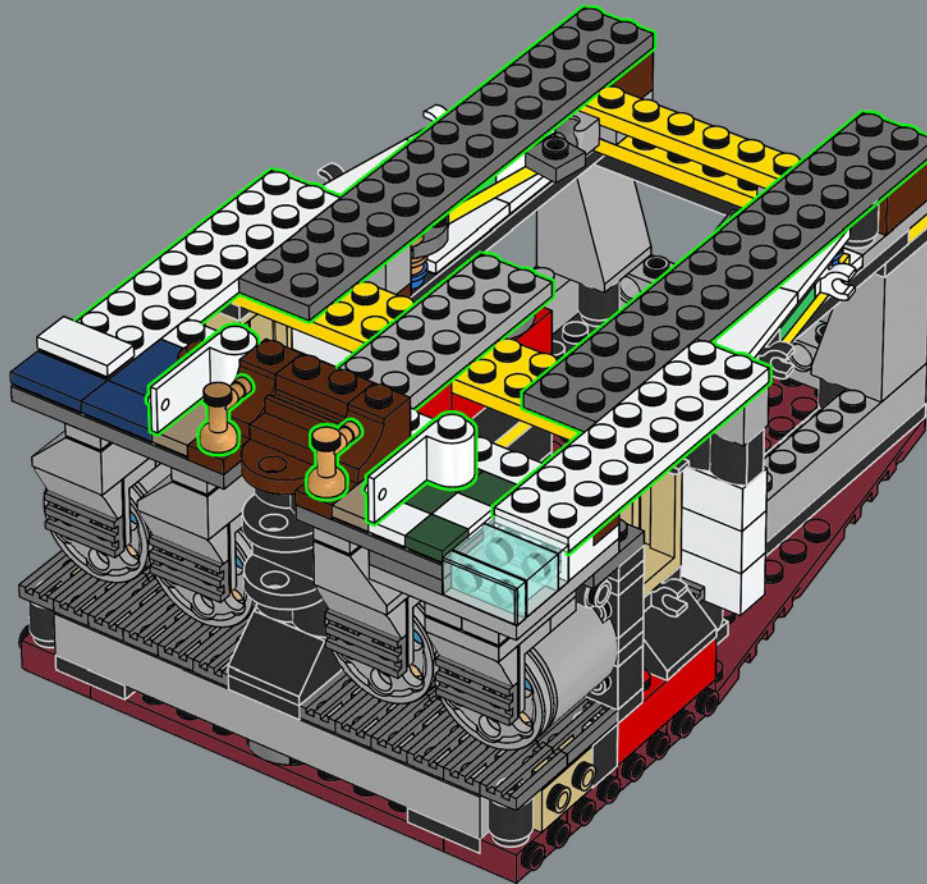

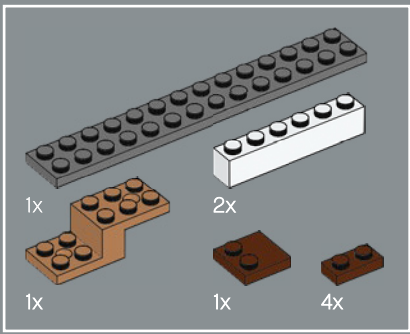

177

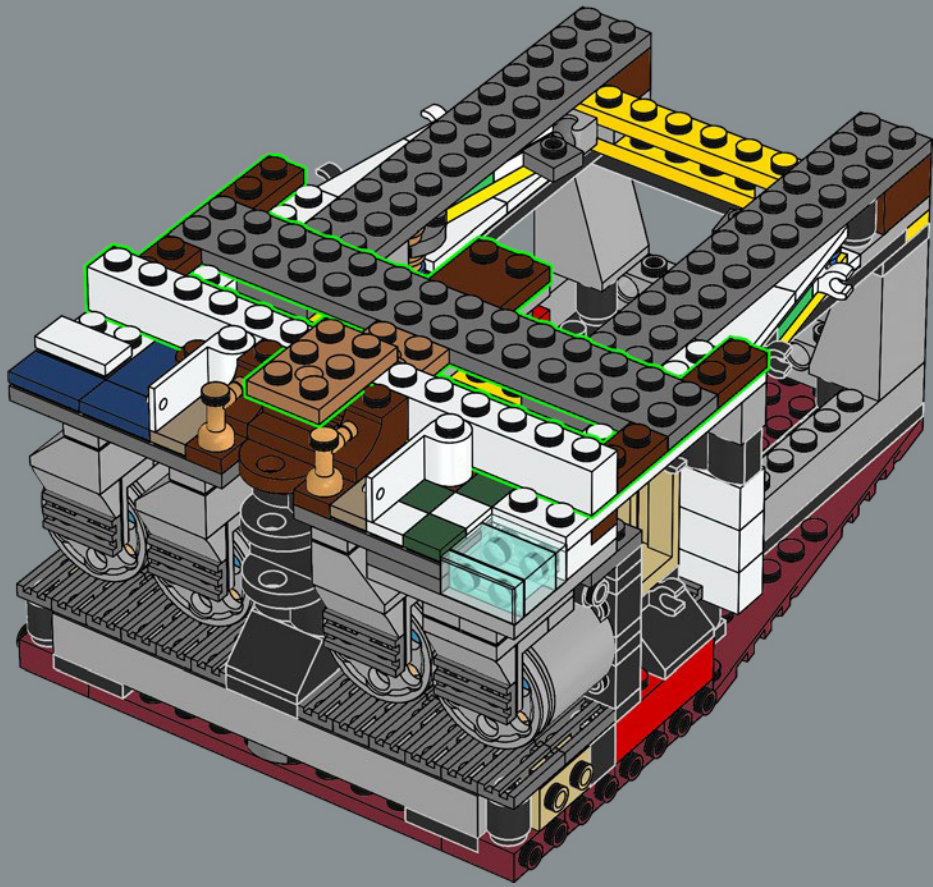

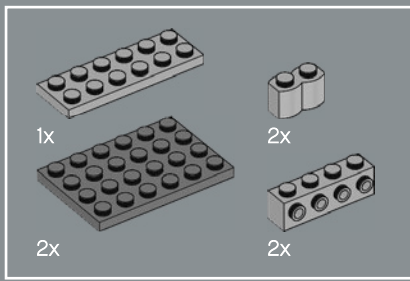

178

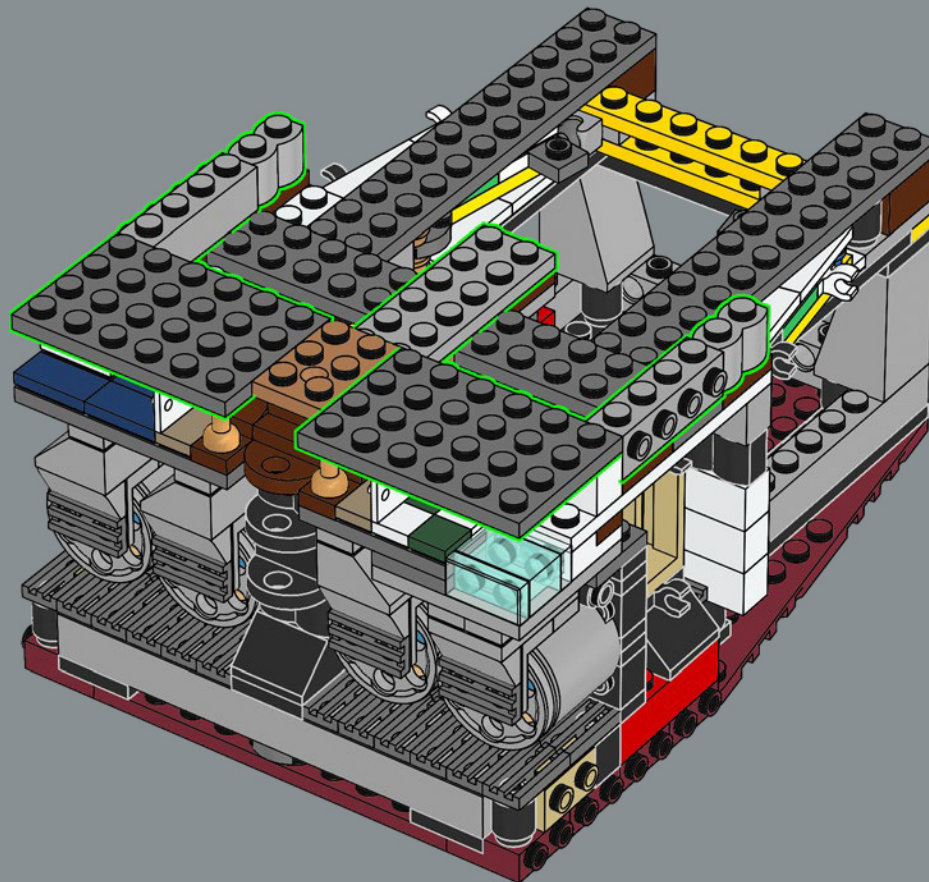

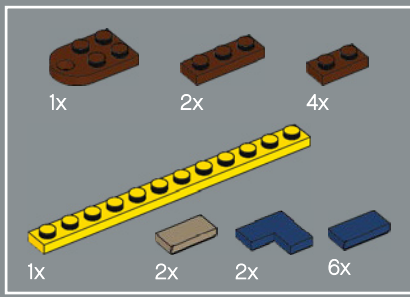

179

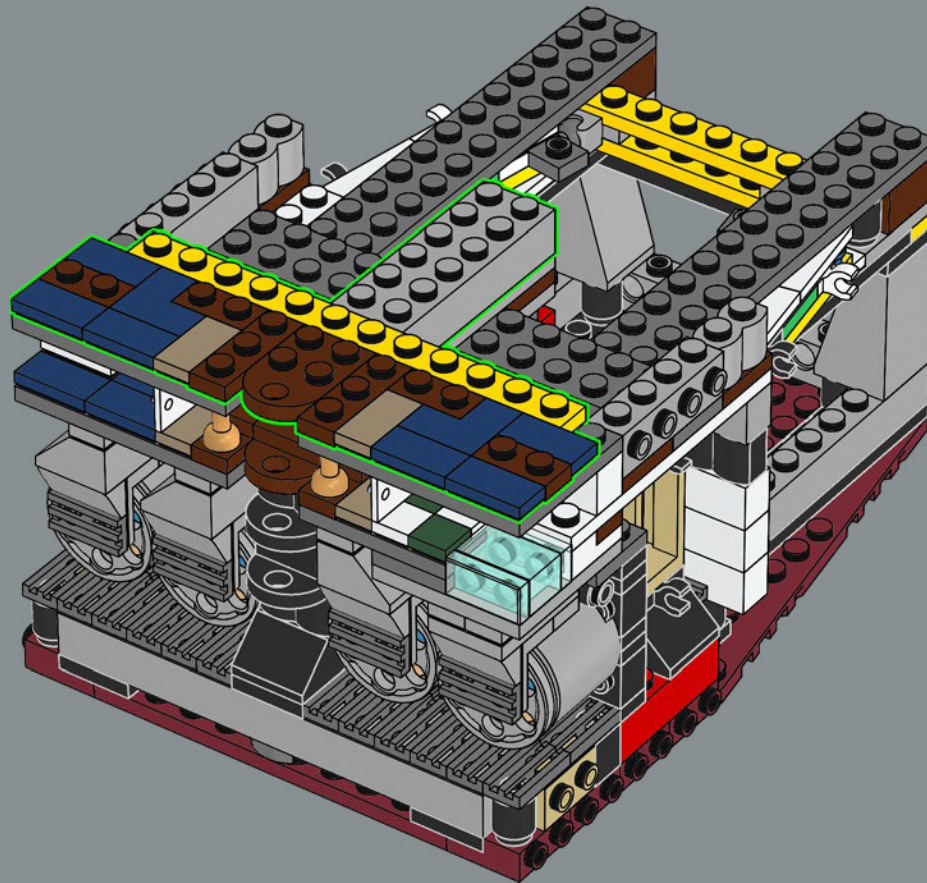

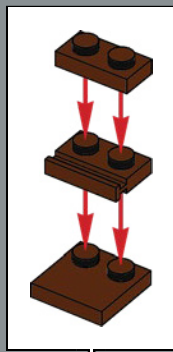
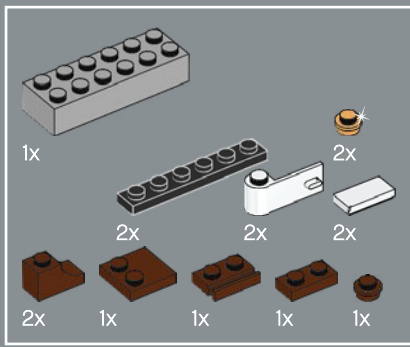

180

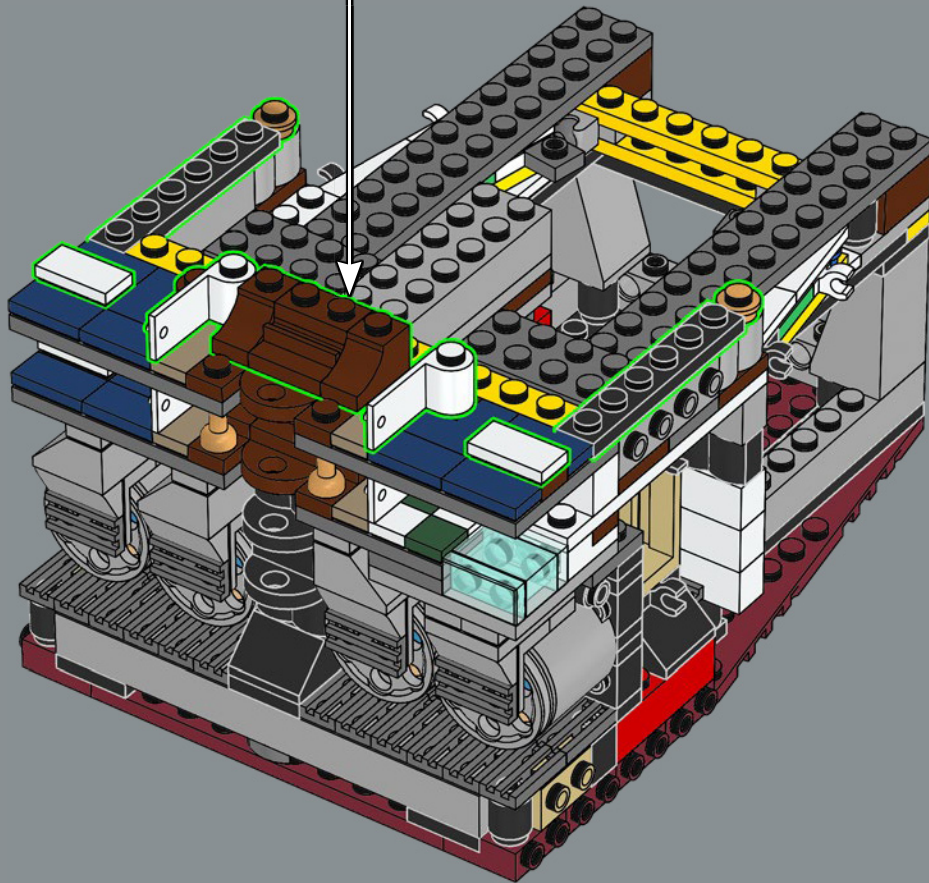

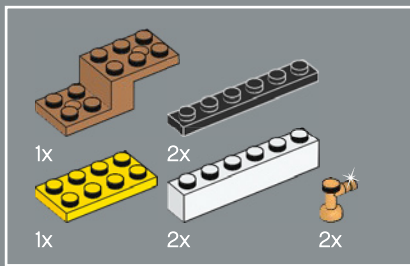

181

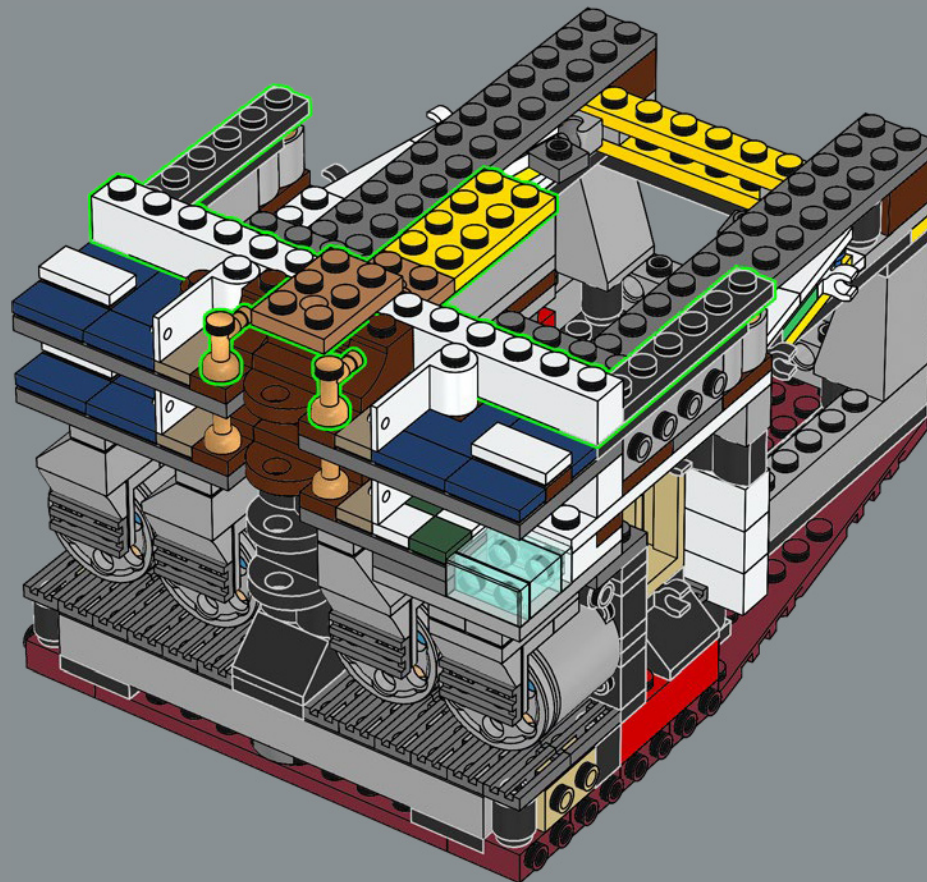

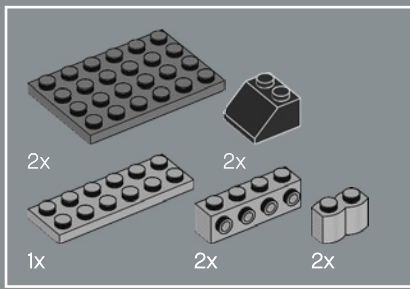

182

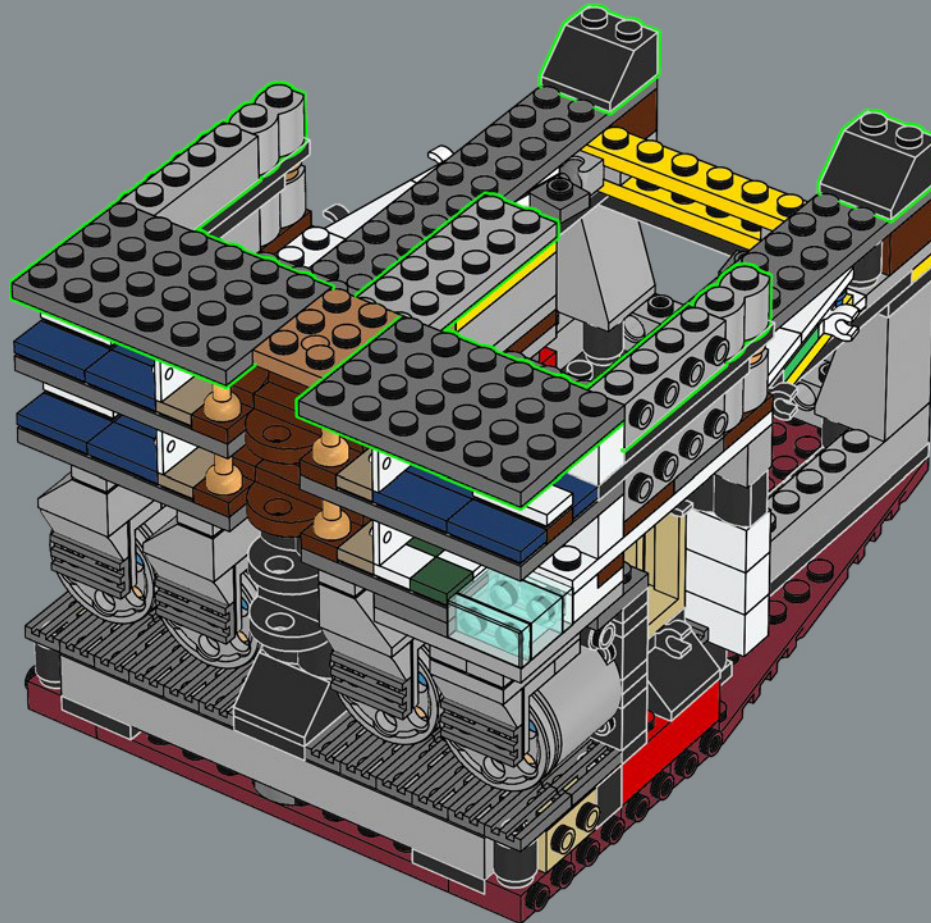

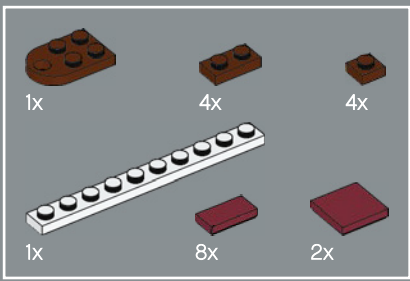

183

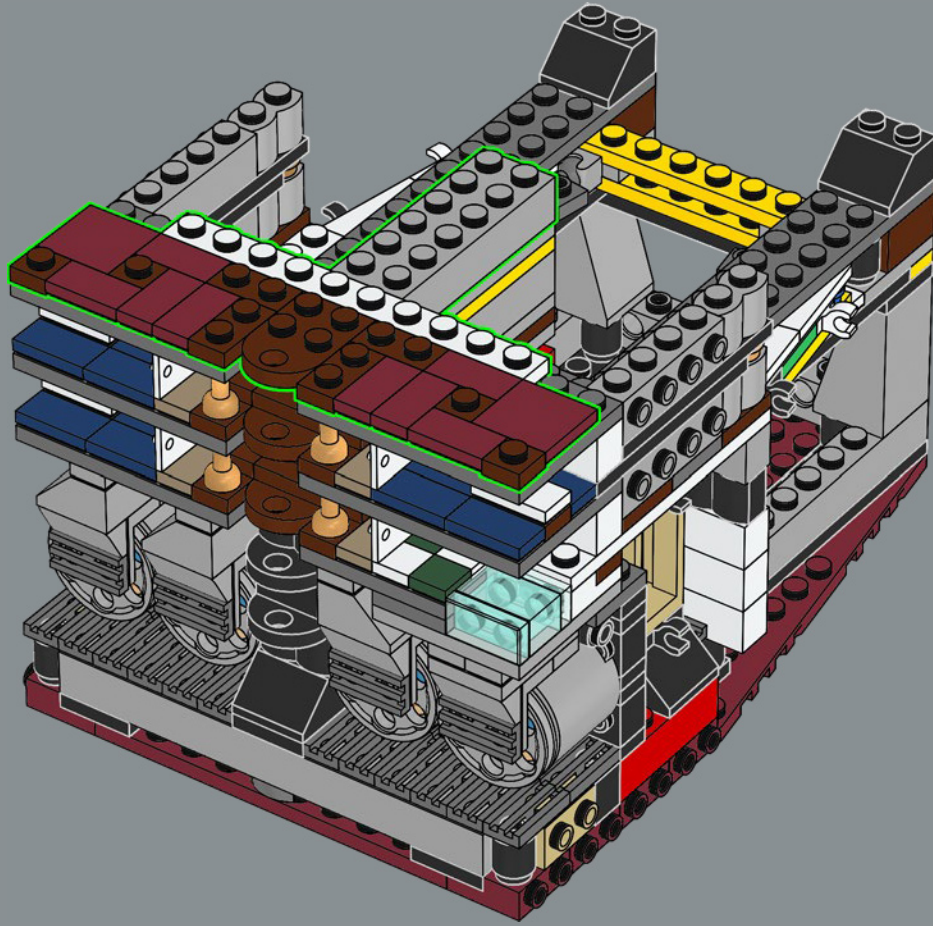

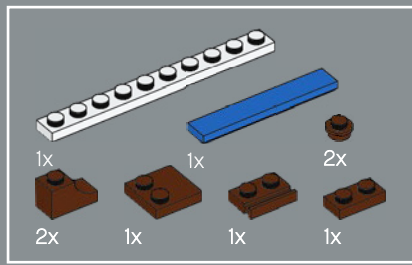

184

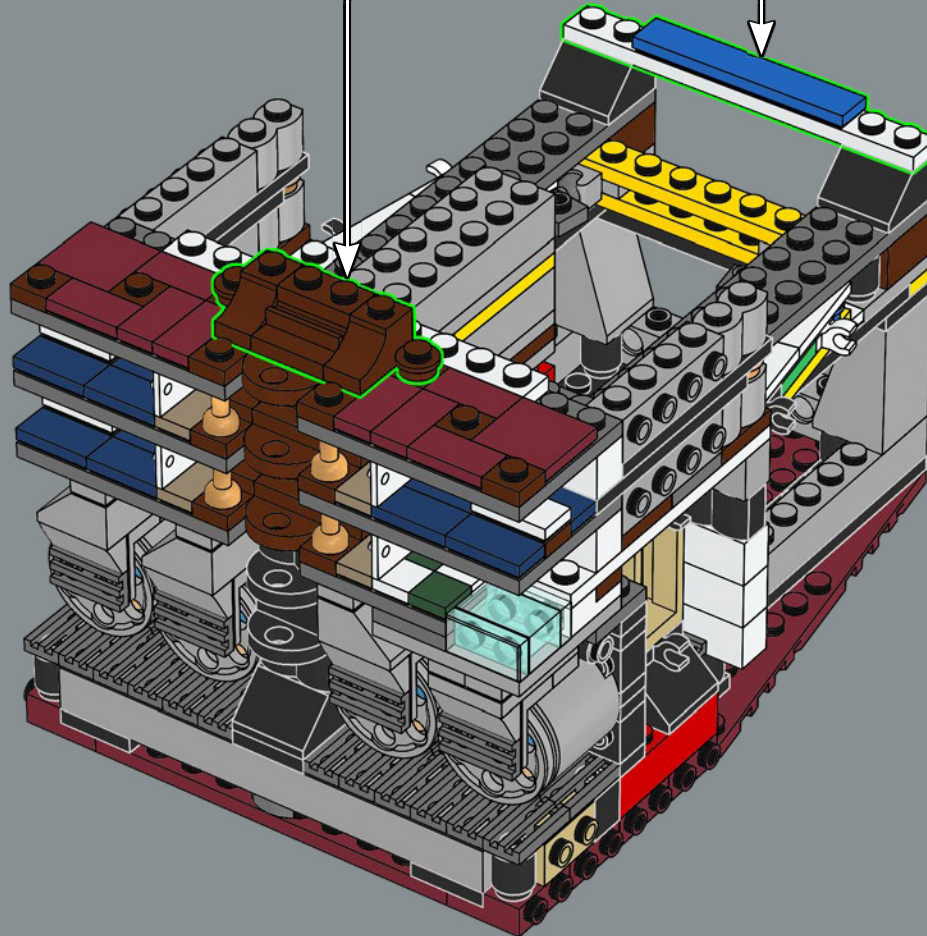
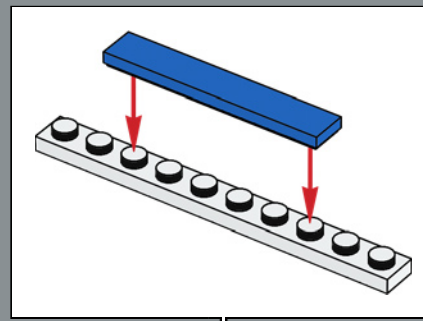
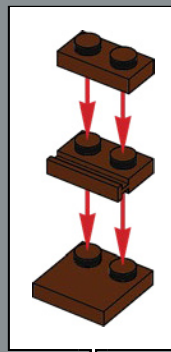

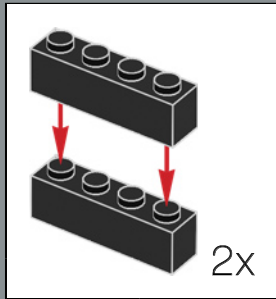
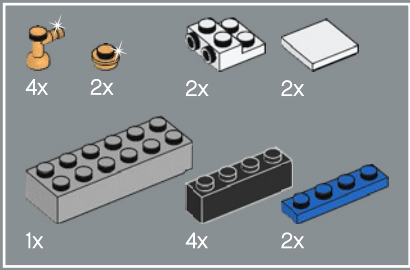

185

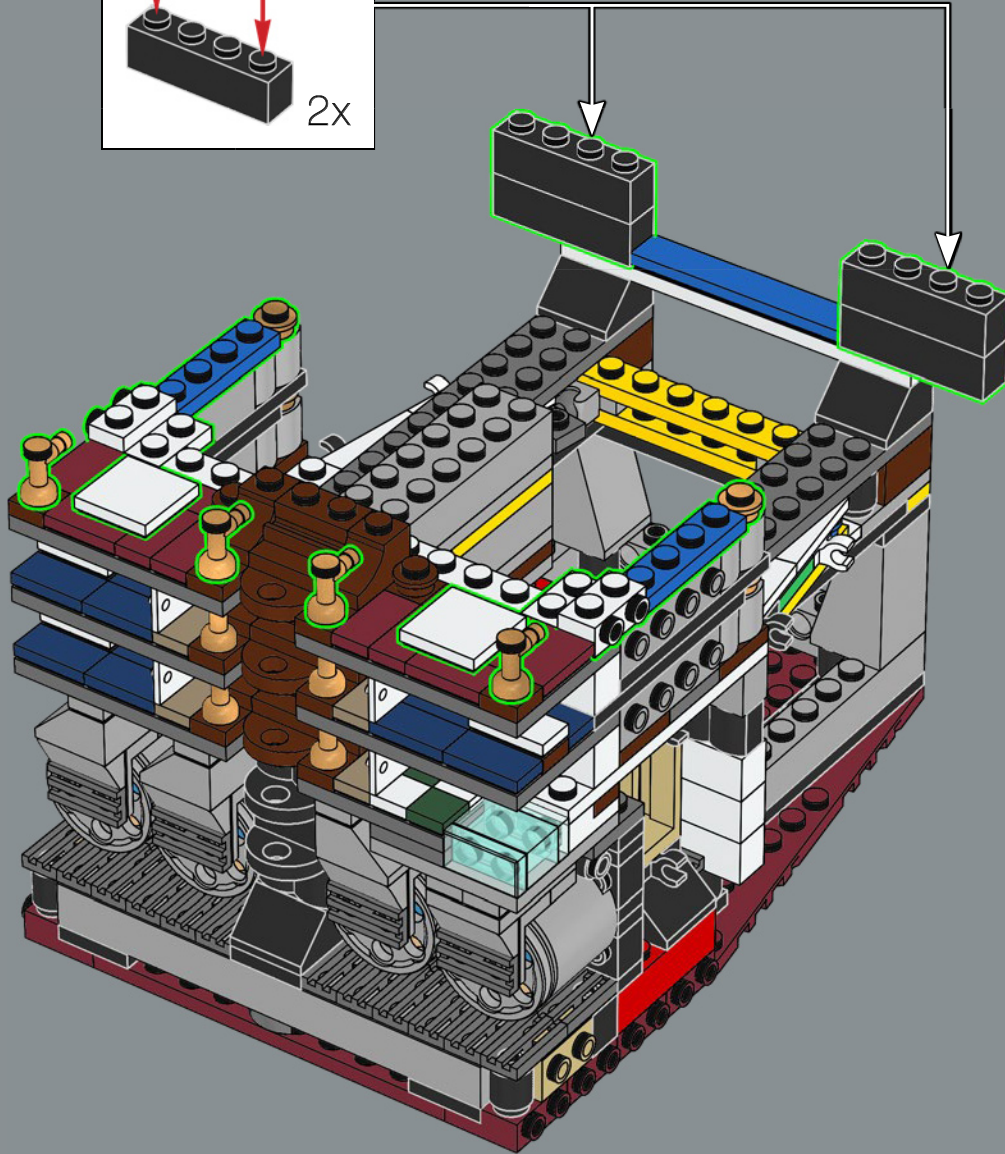

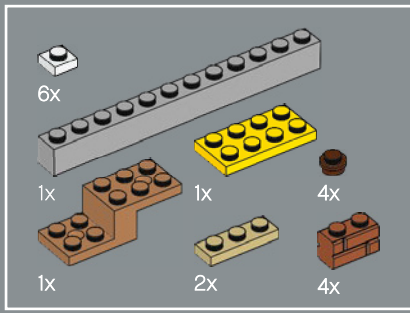

186

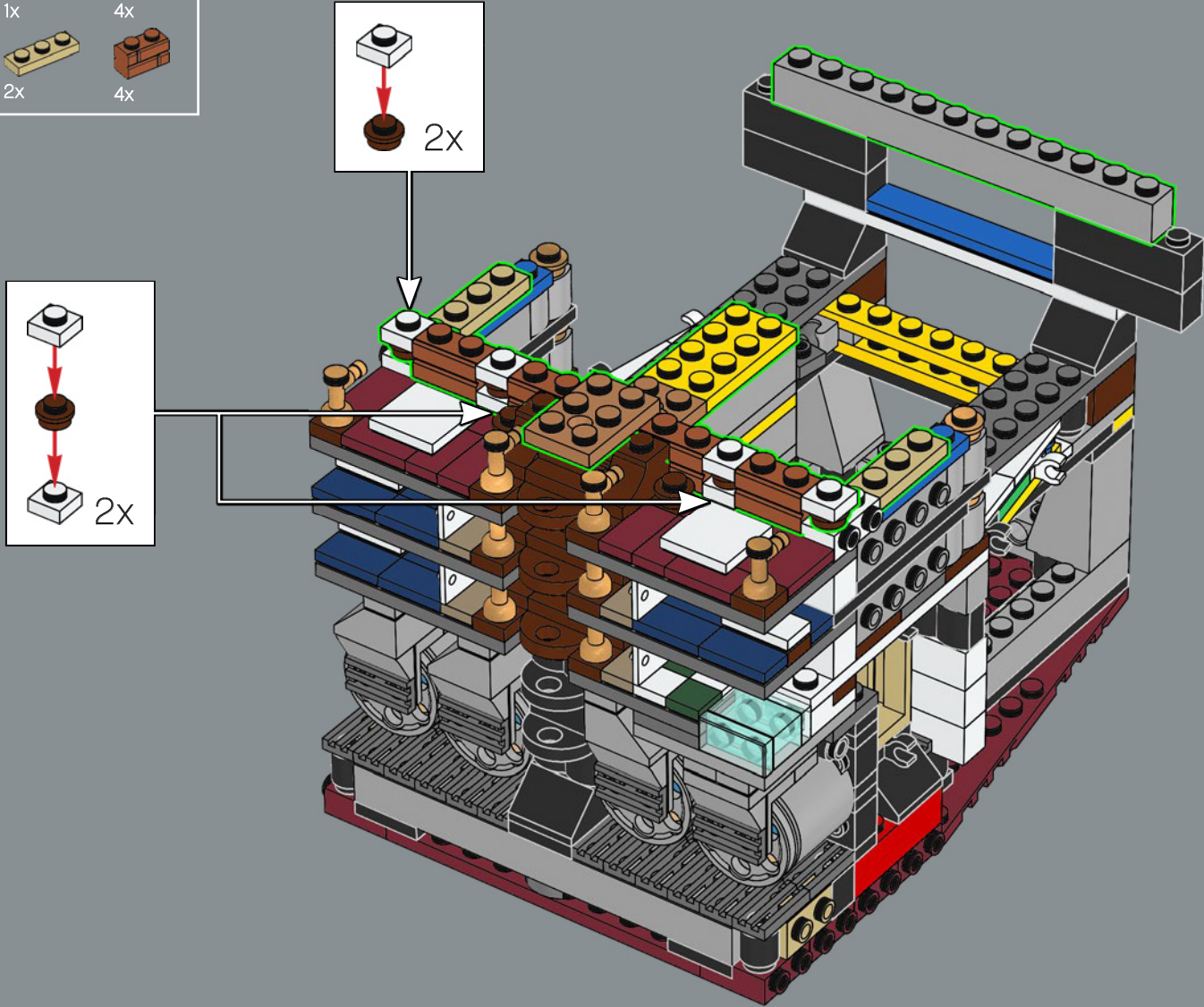

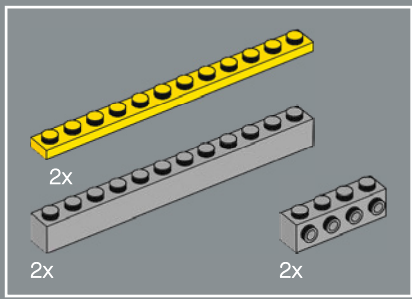

187

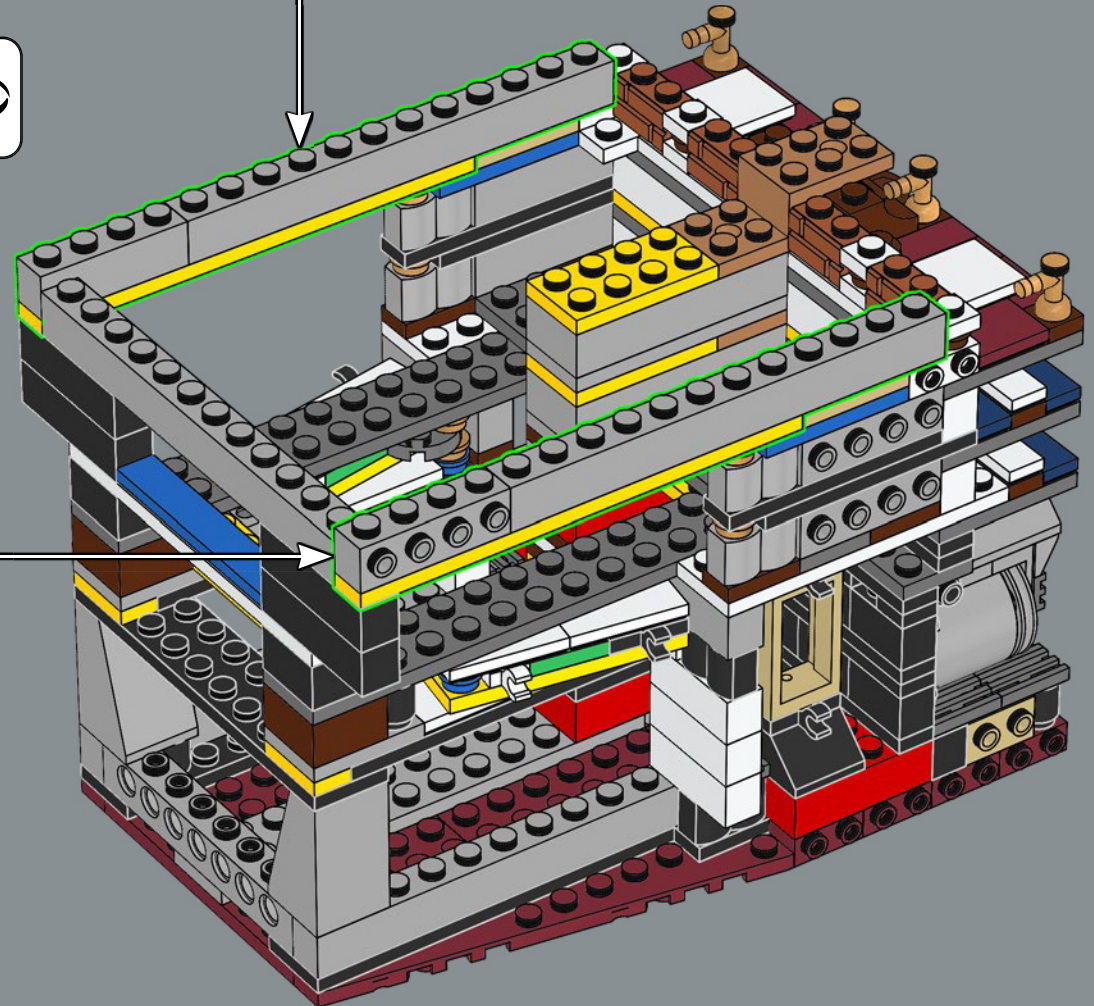
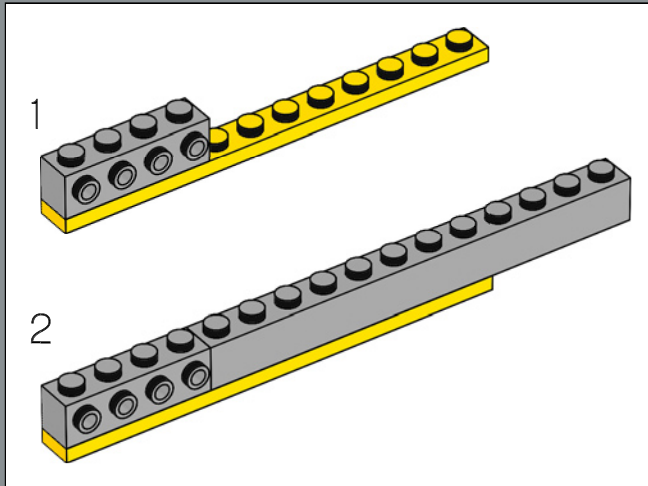
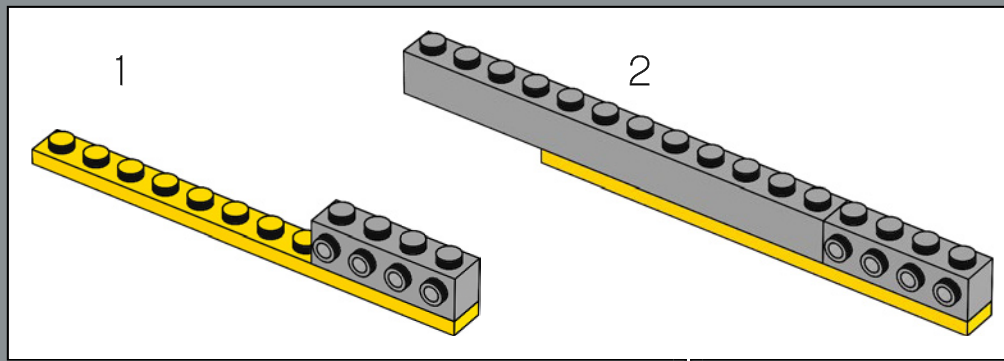

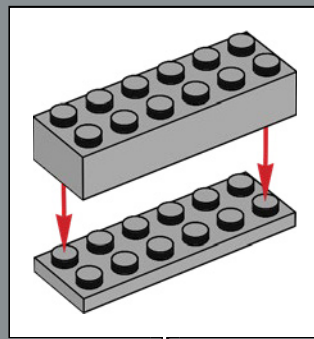
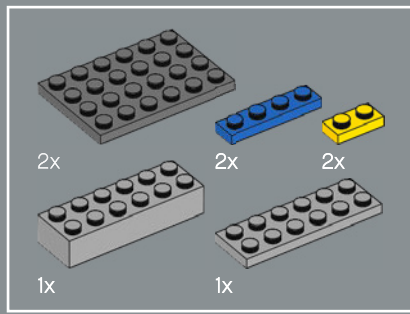

188

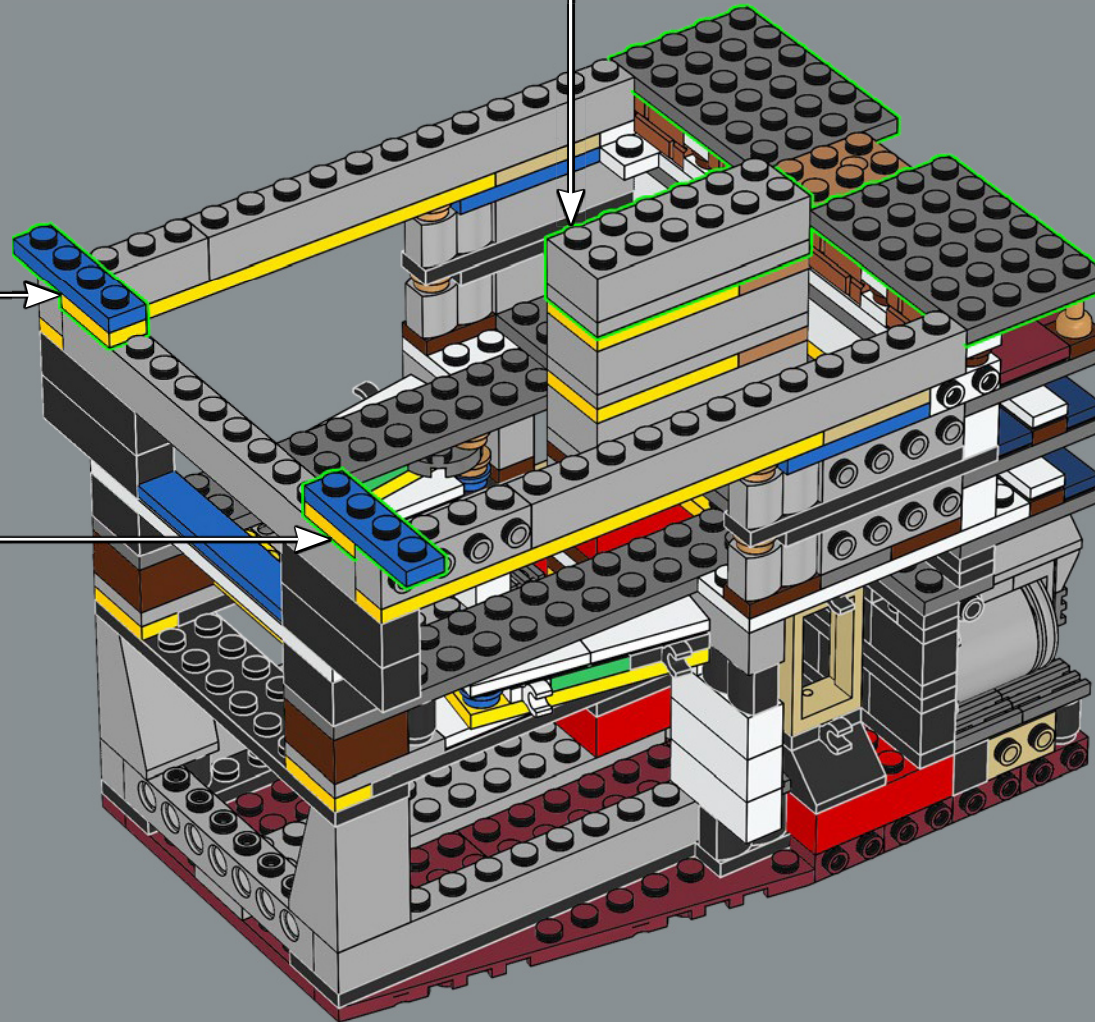
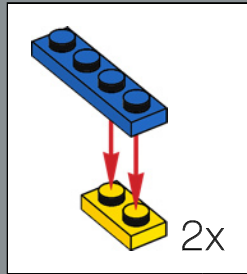

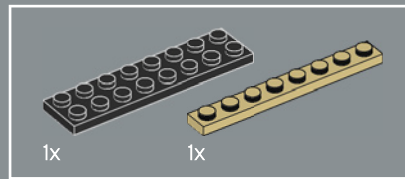
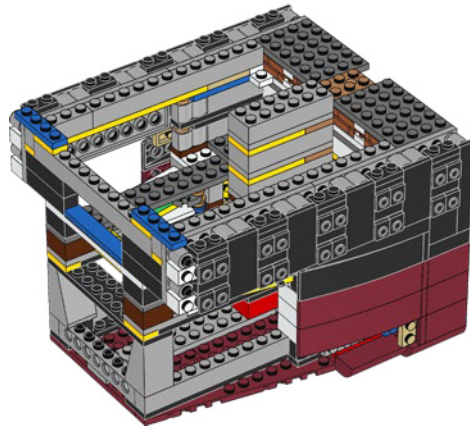
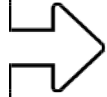

190

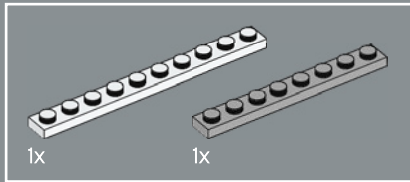
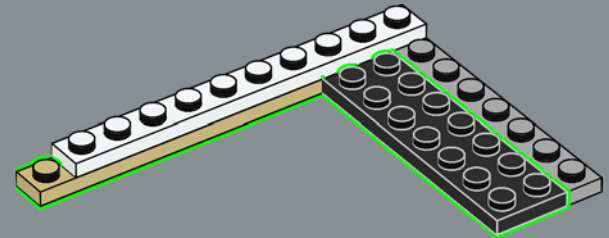

189

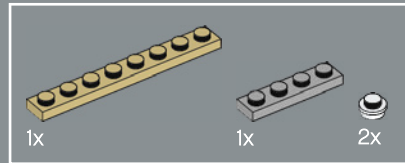
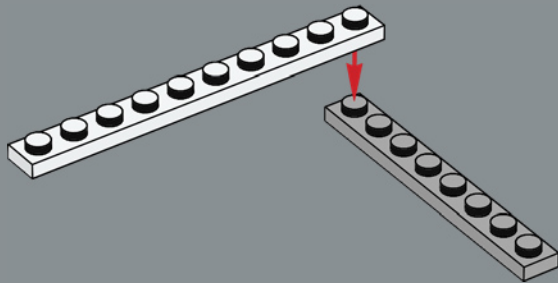

191

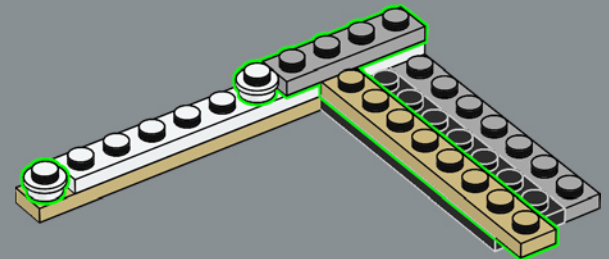

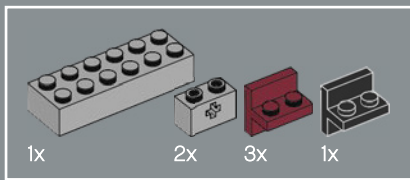

192

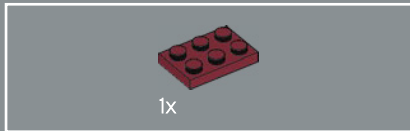
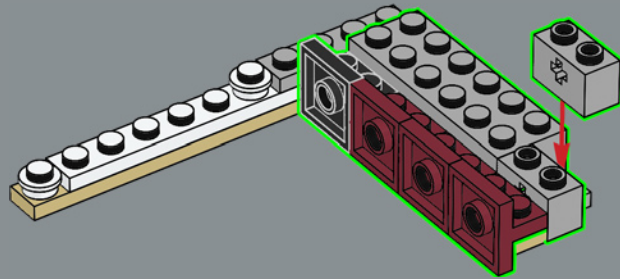

193

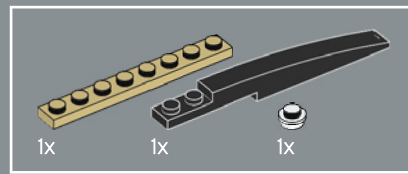
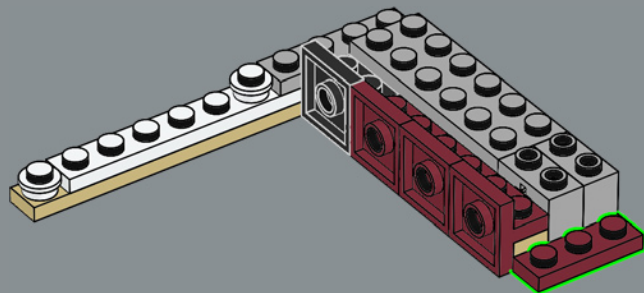

194

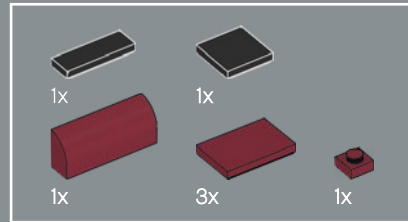
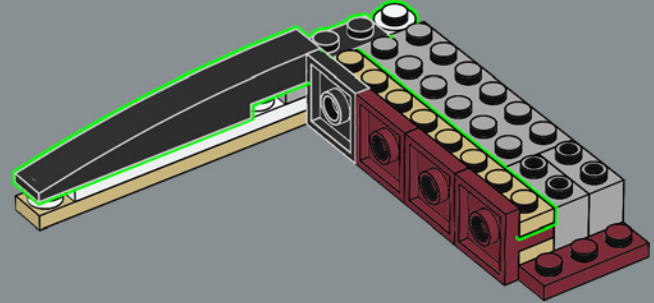

195

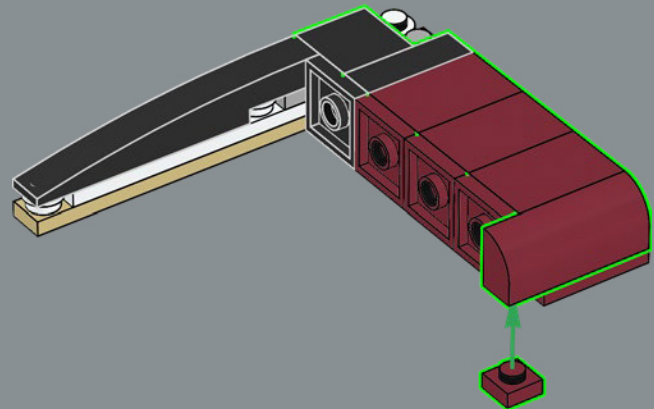

196

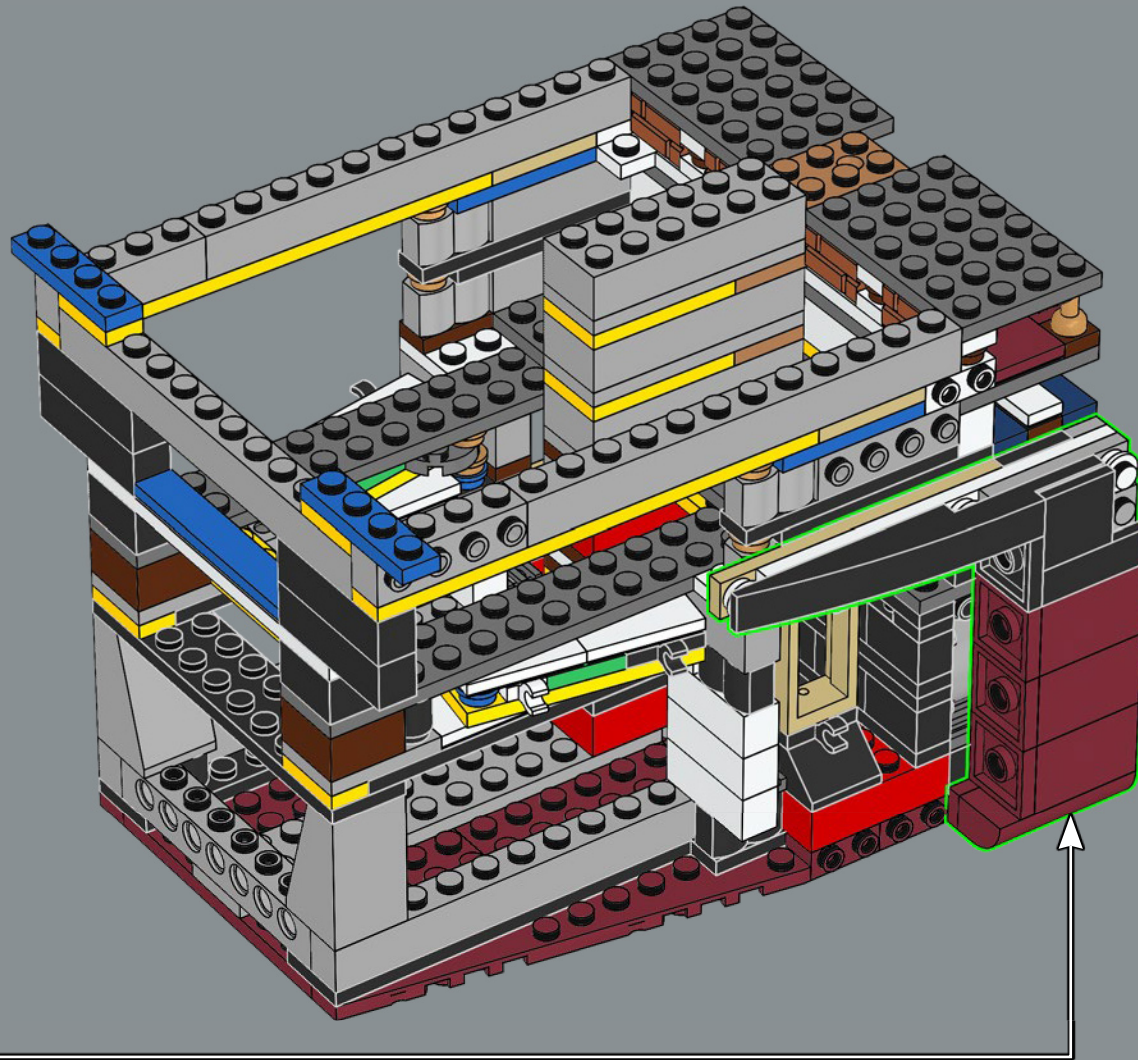

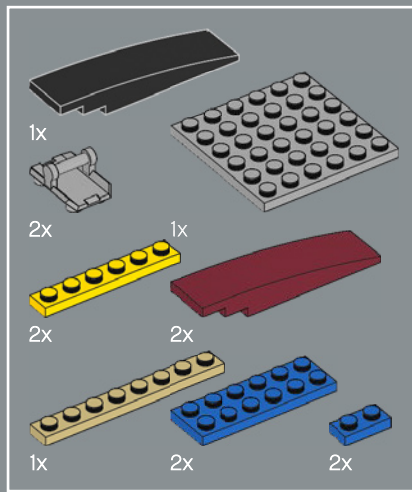

197

1

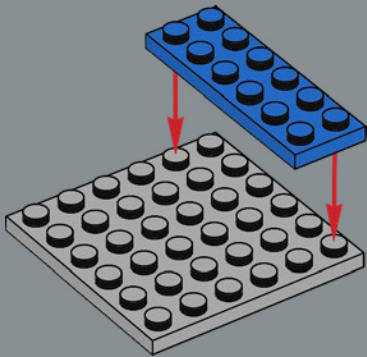

2

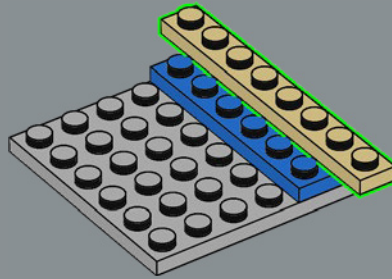

3

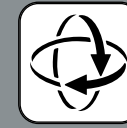
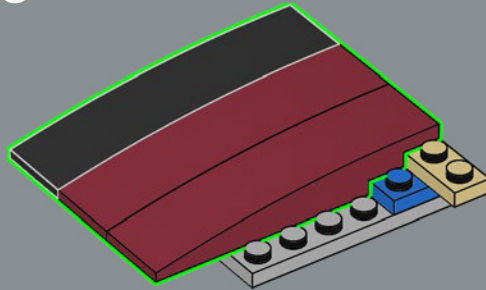

4

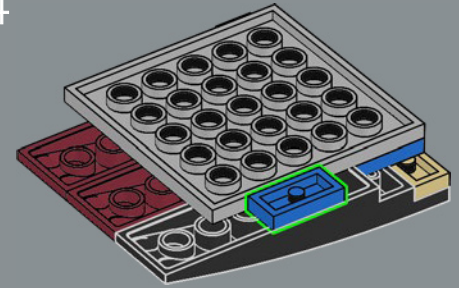

5

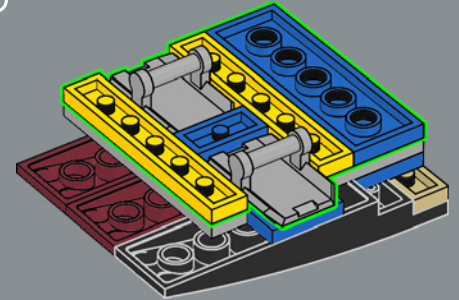

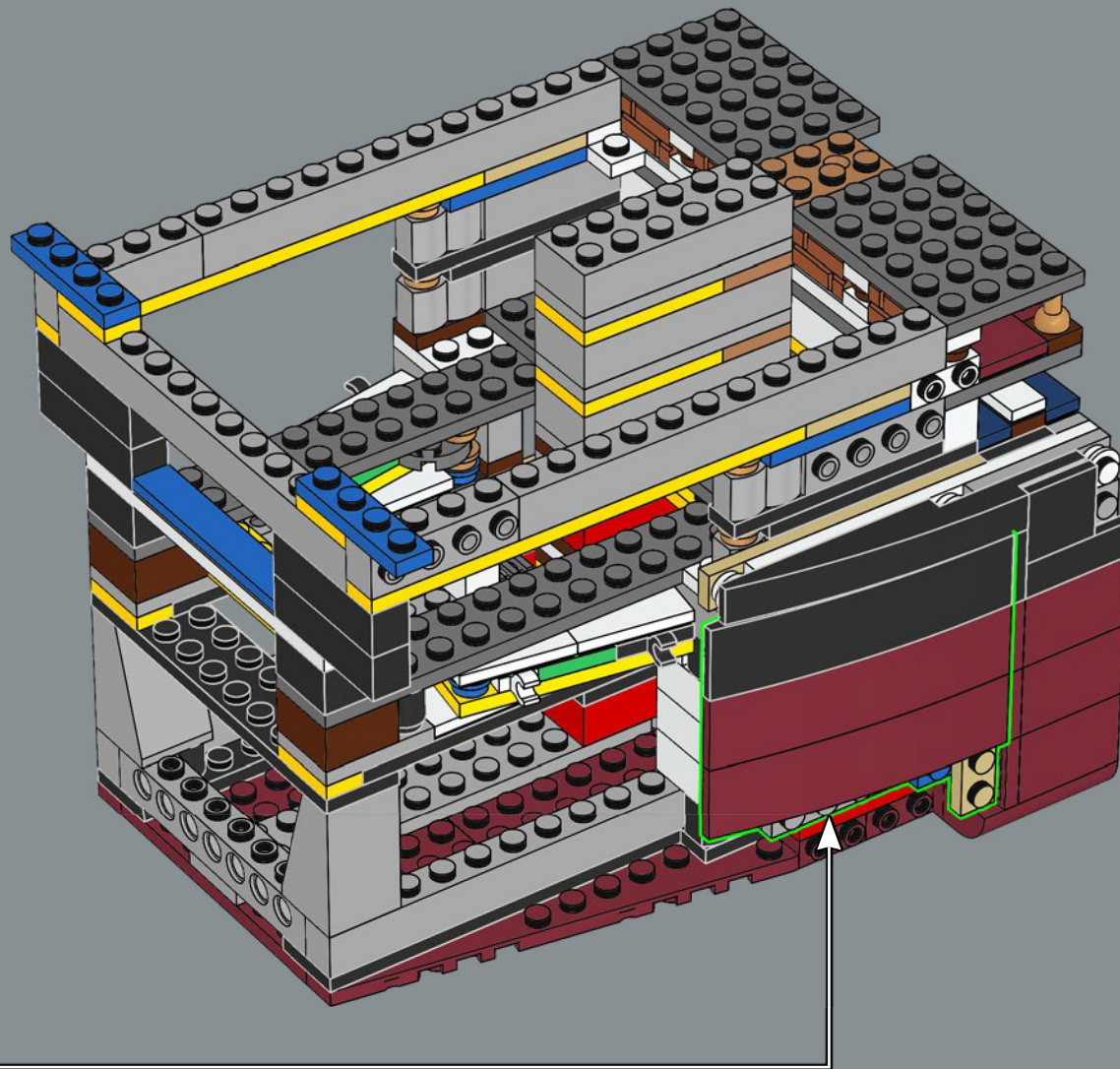

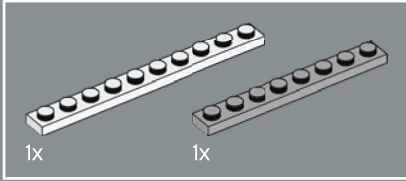
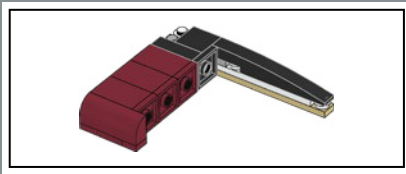

198

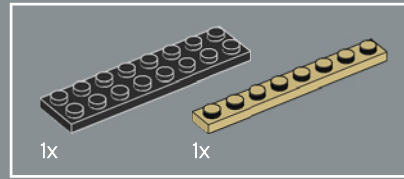
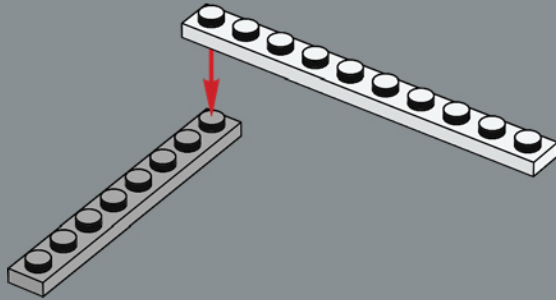

199

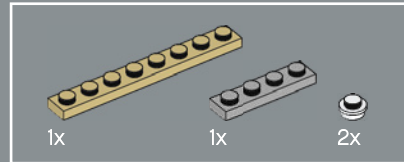
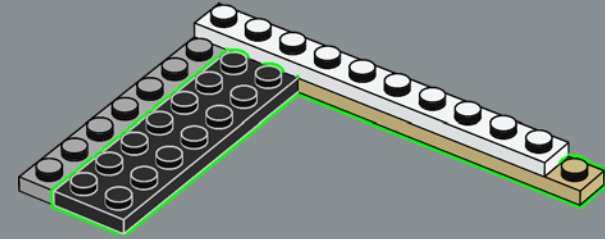

200

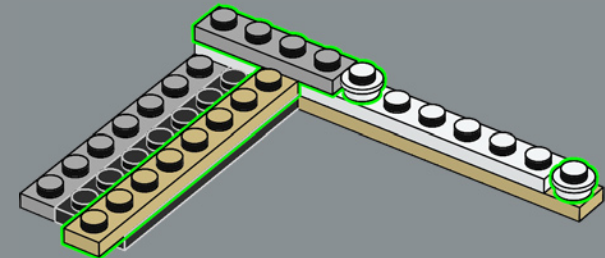

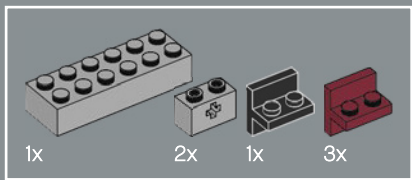

201

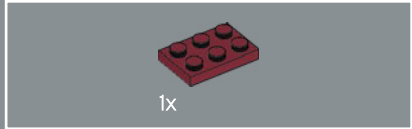
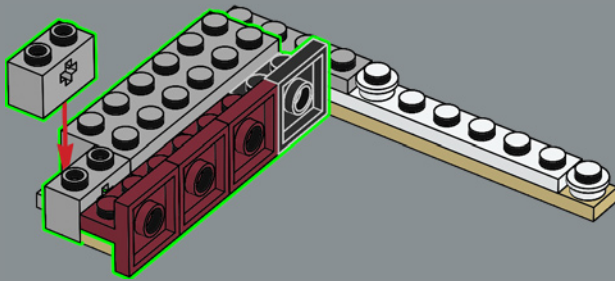

202

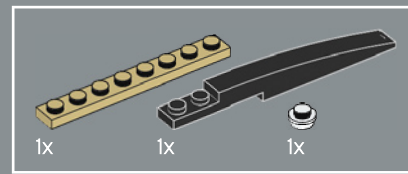
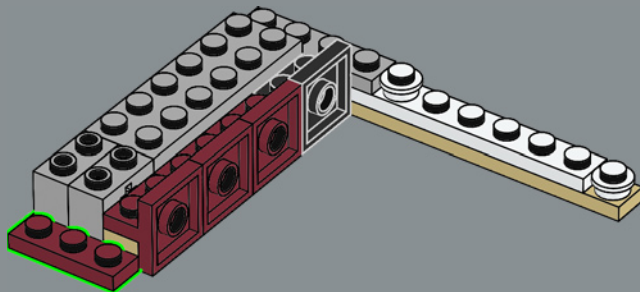

203

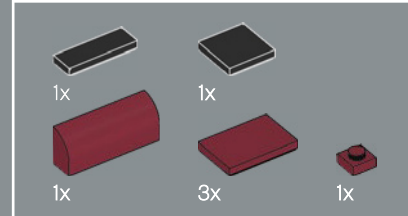
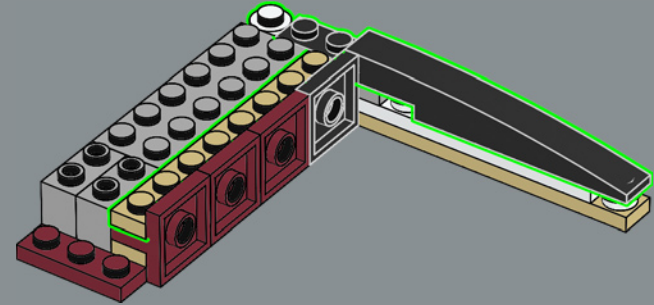

204

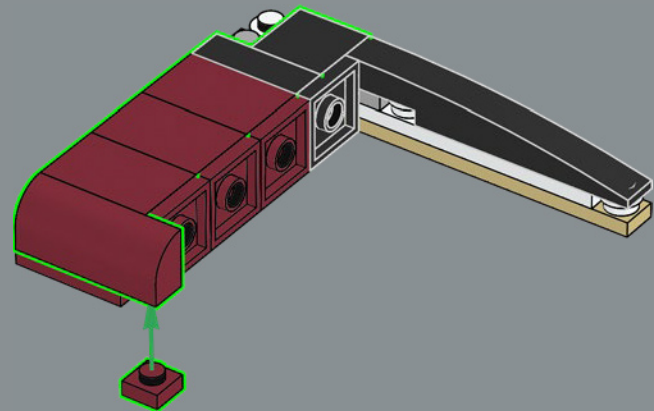

205

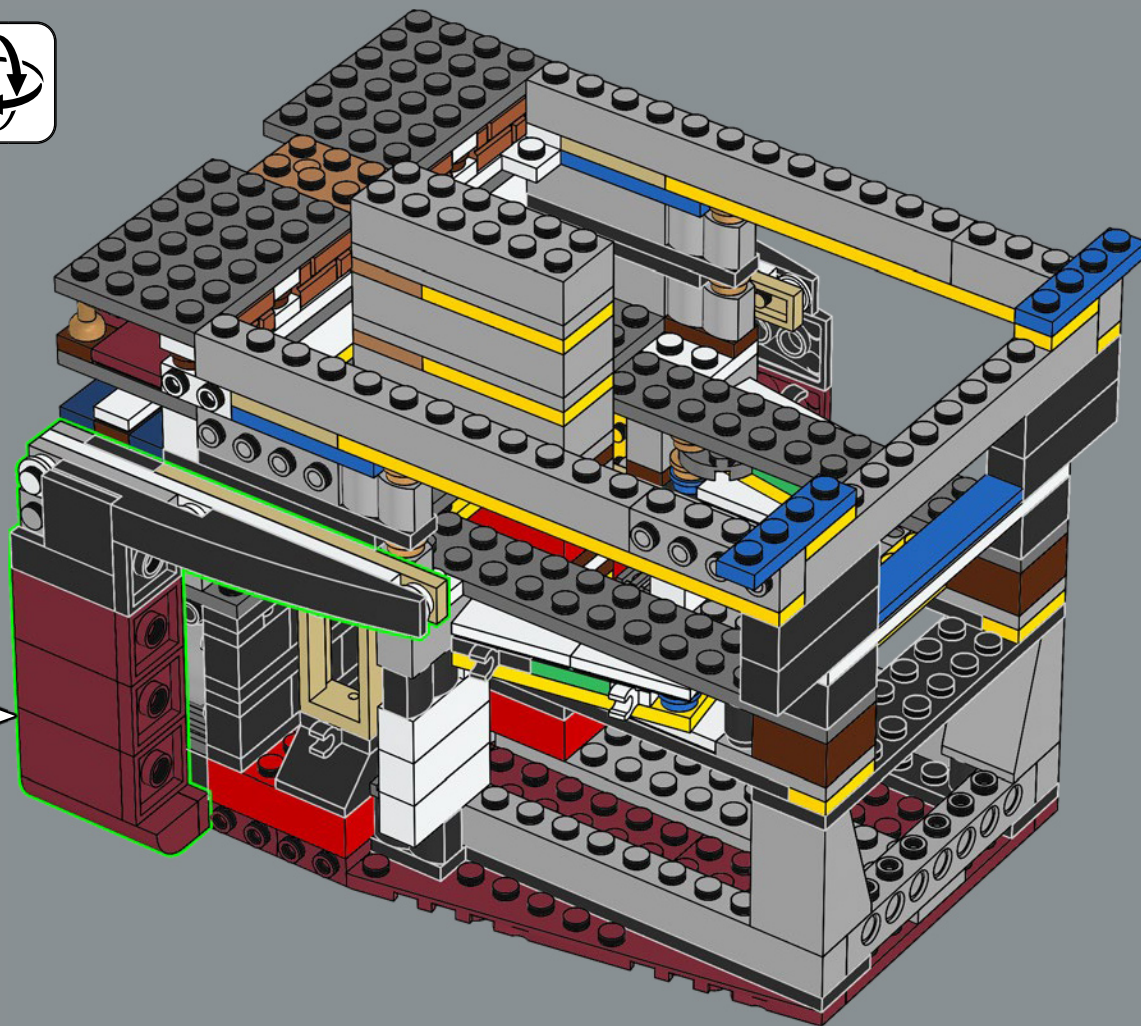

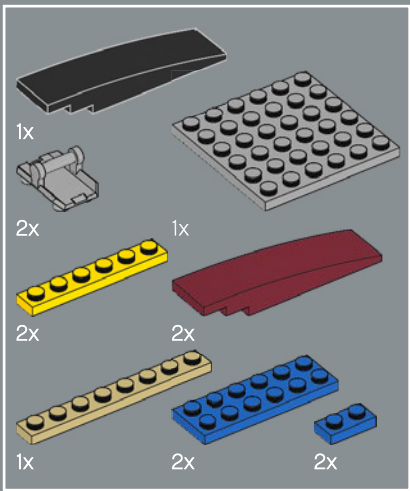

206

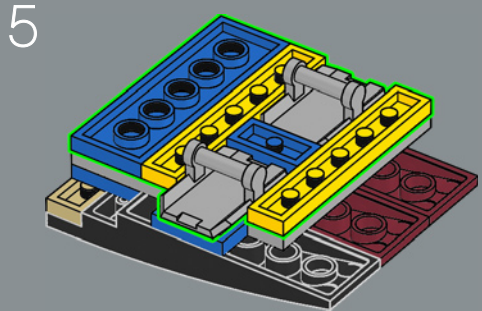
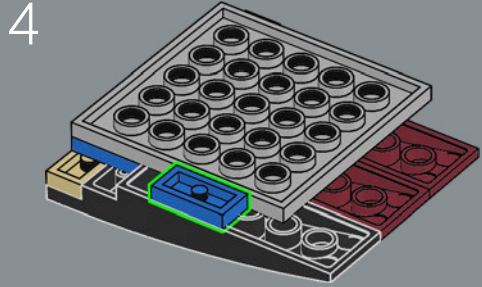
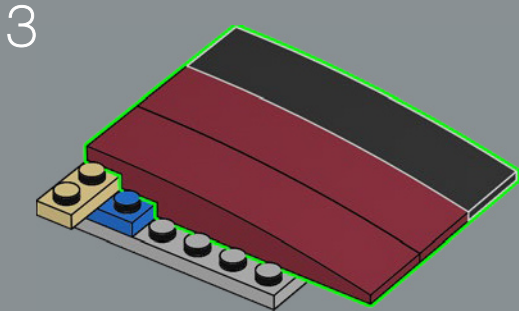
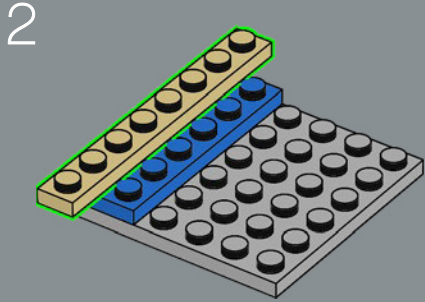
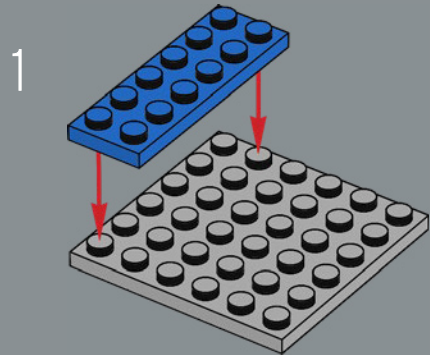

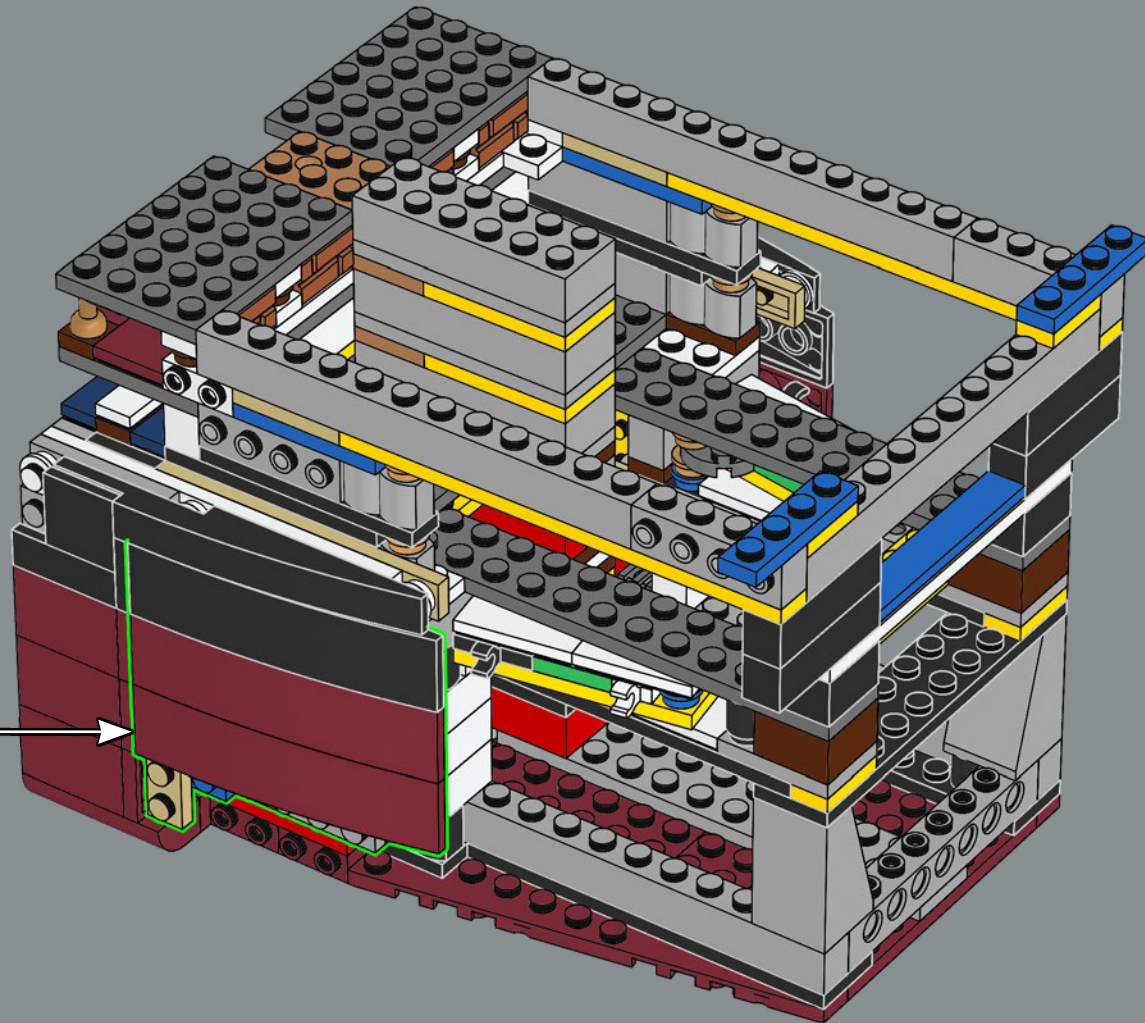

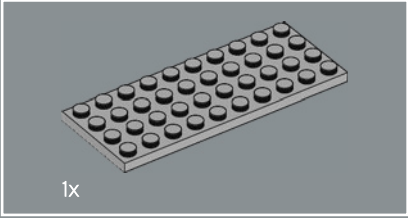
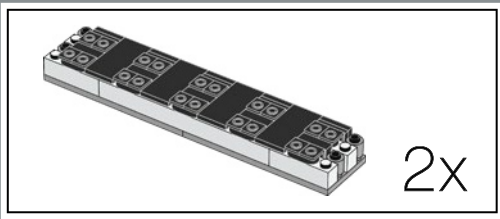

207

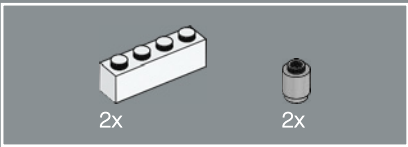
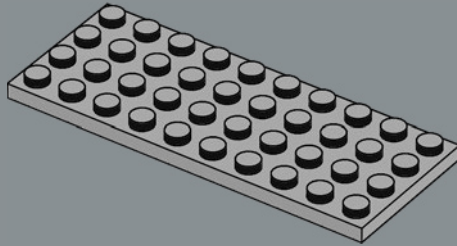

208

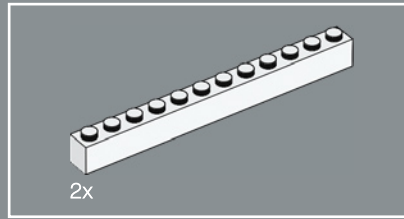
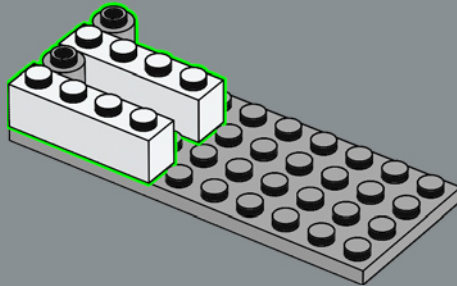

209

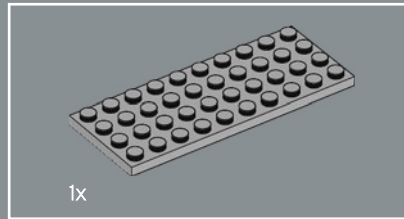
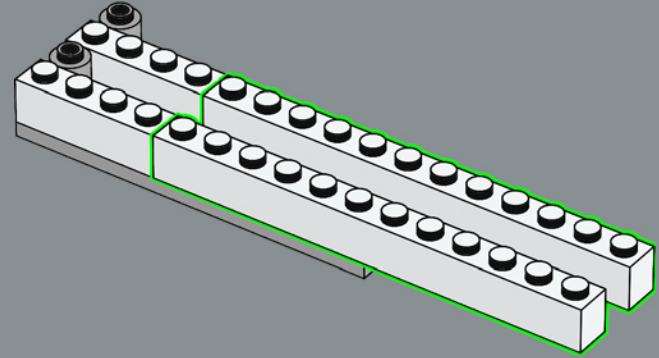

210

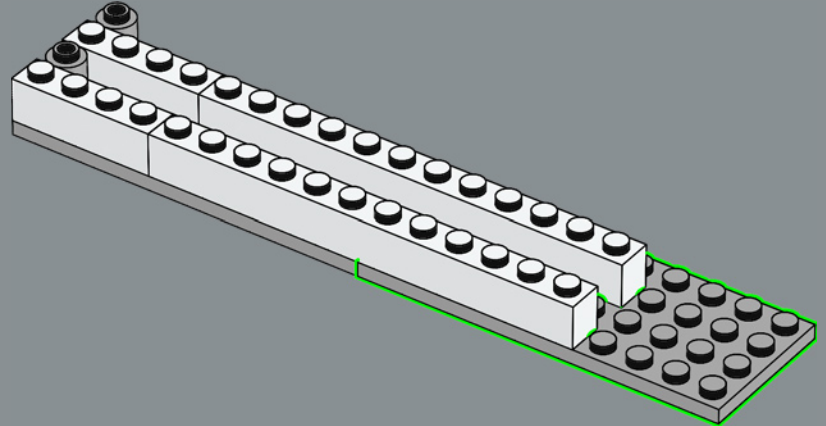

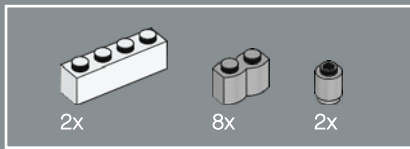

211

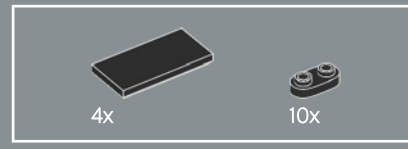
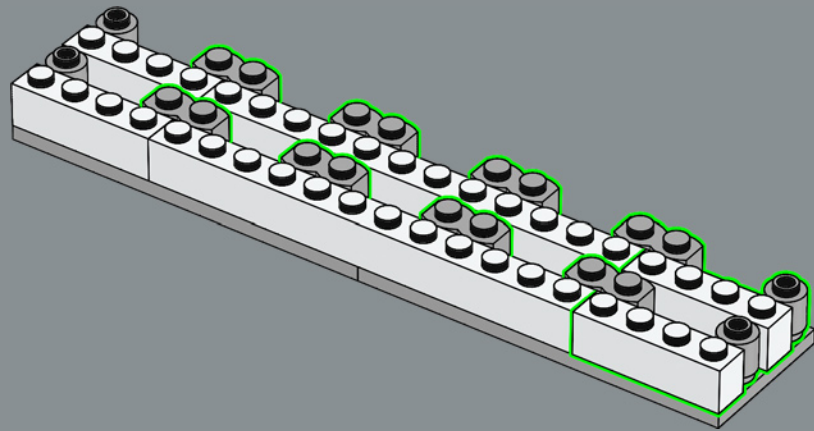

212

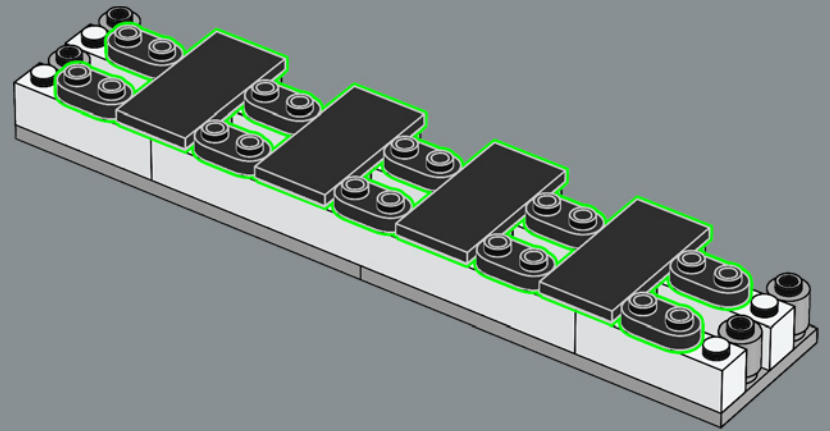

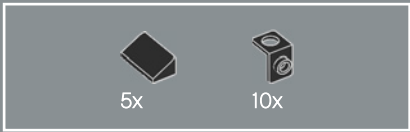

213

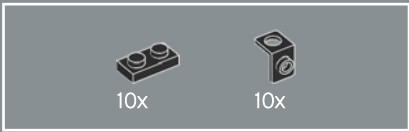
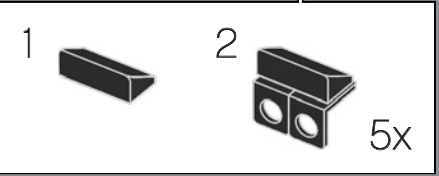
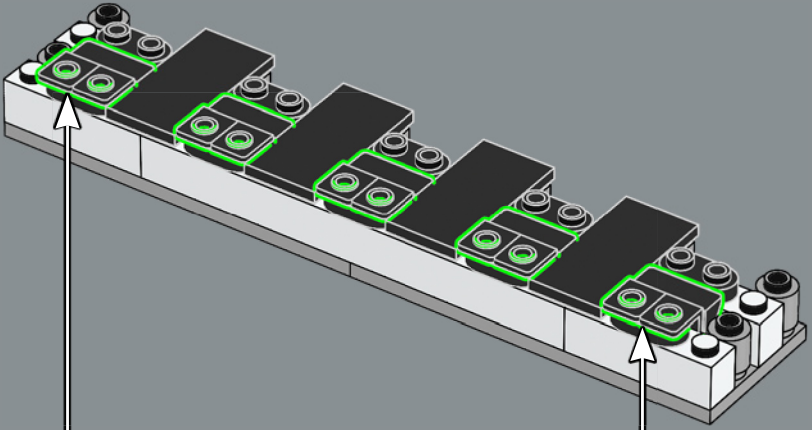

214

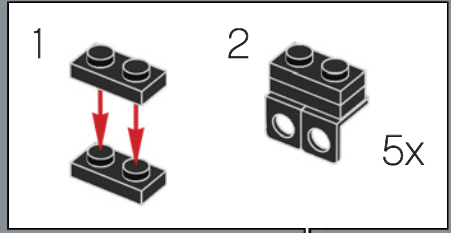
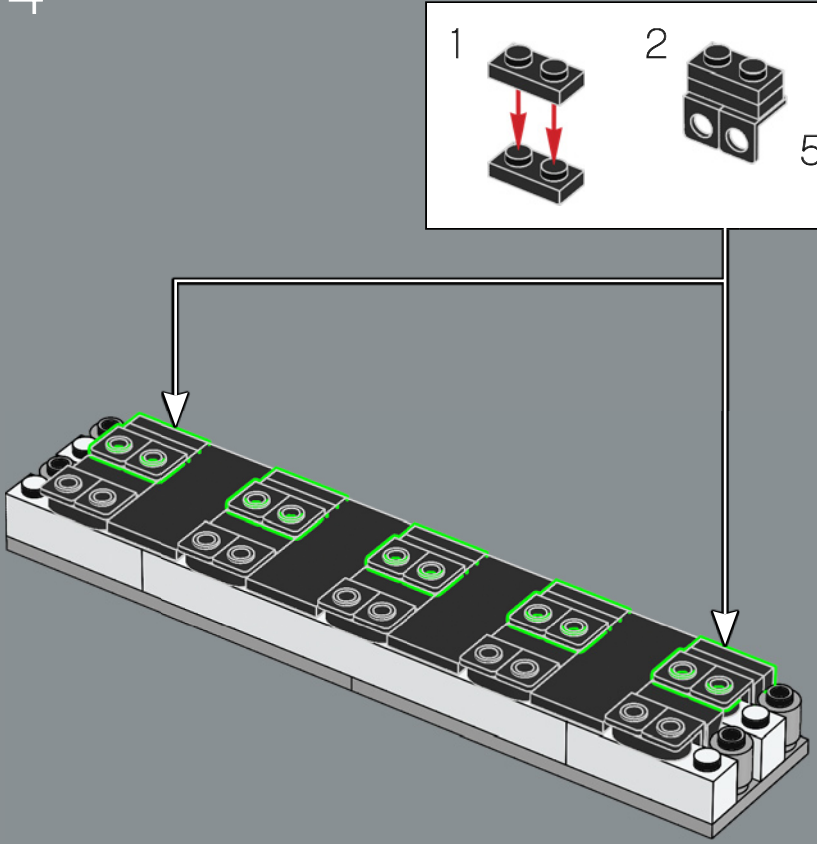

2x

215

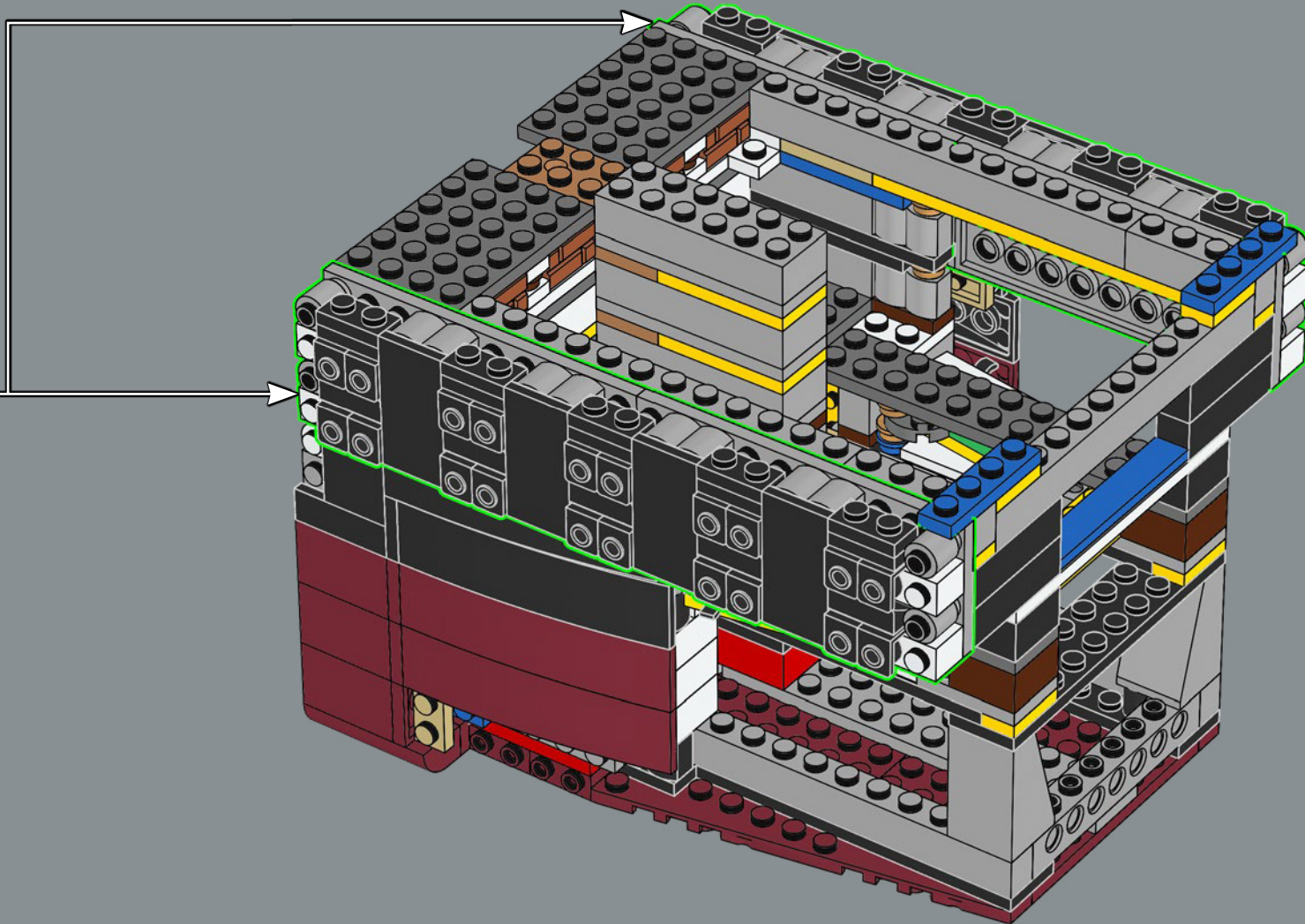

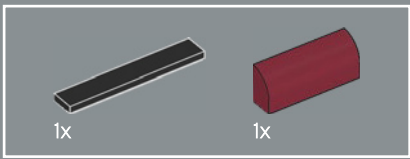

216

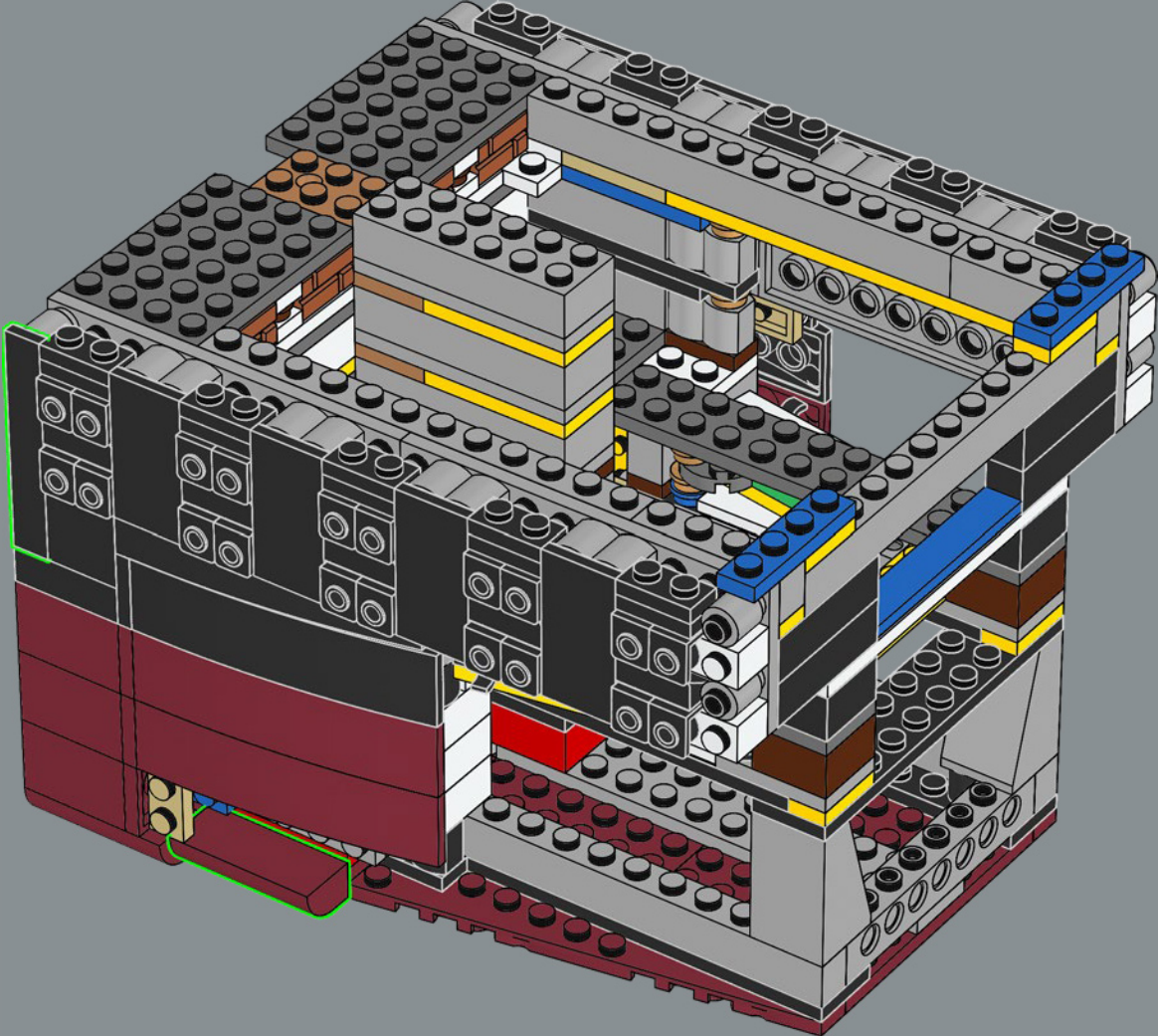

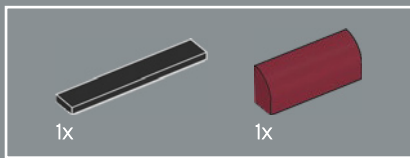

217

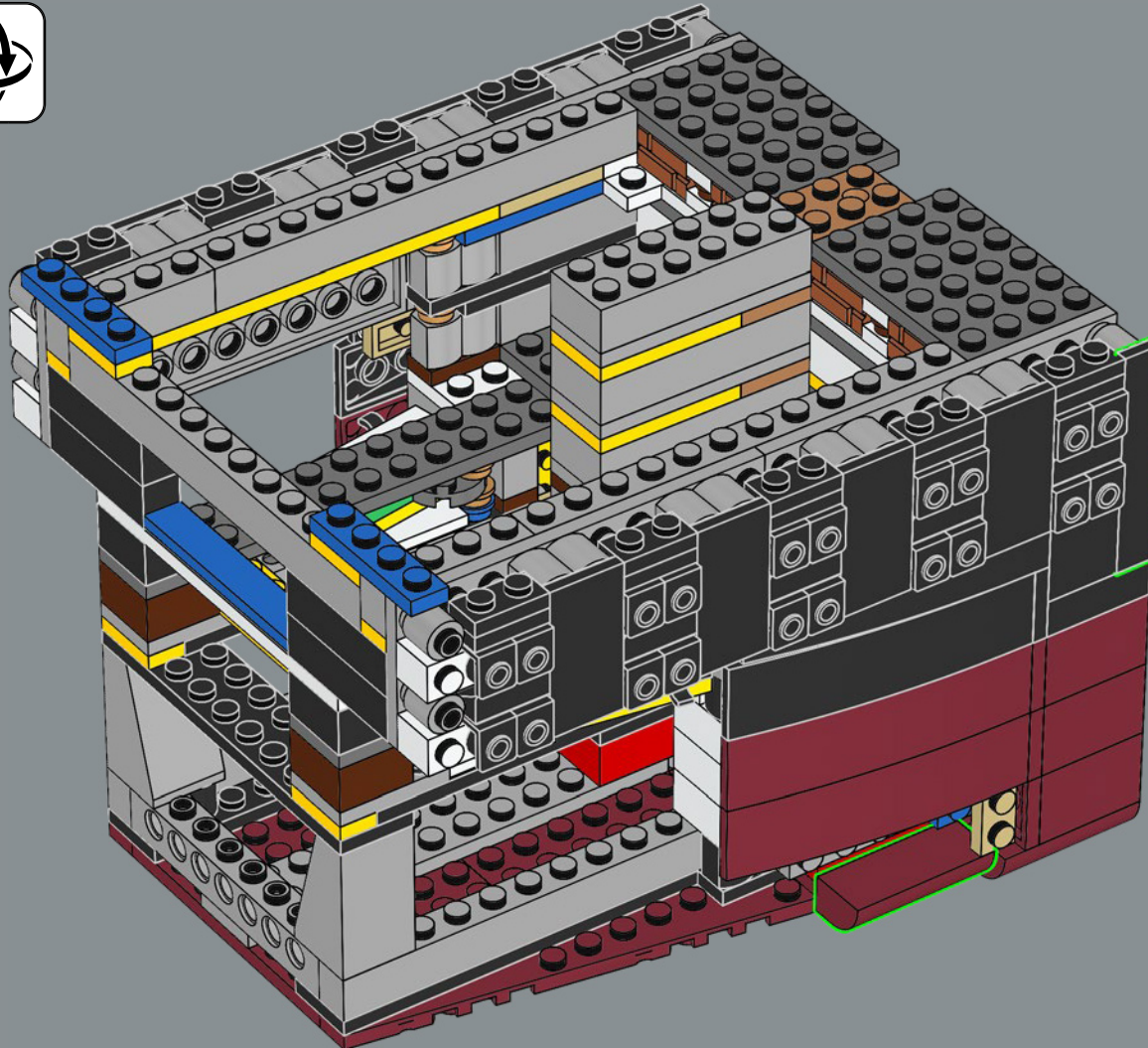

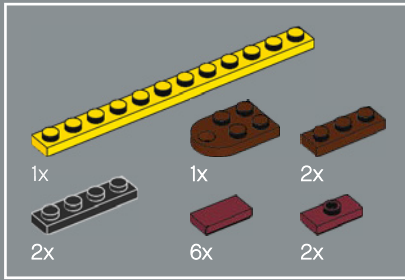
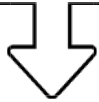

218

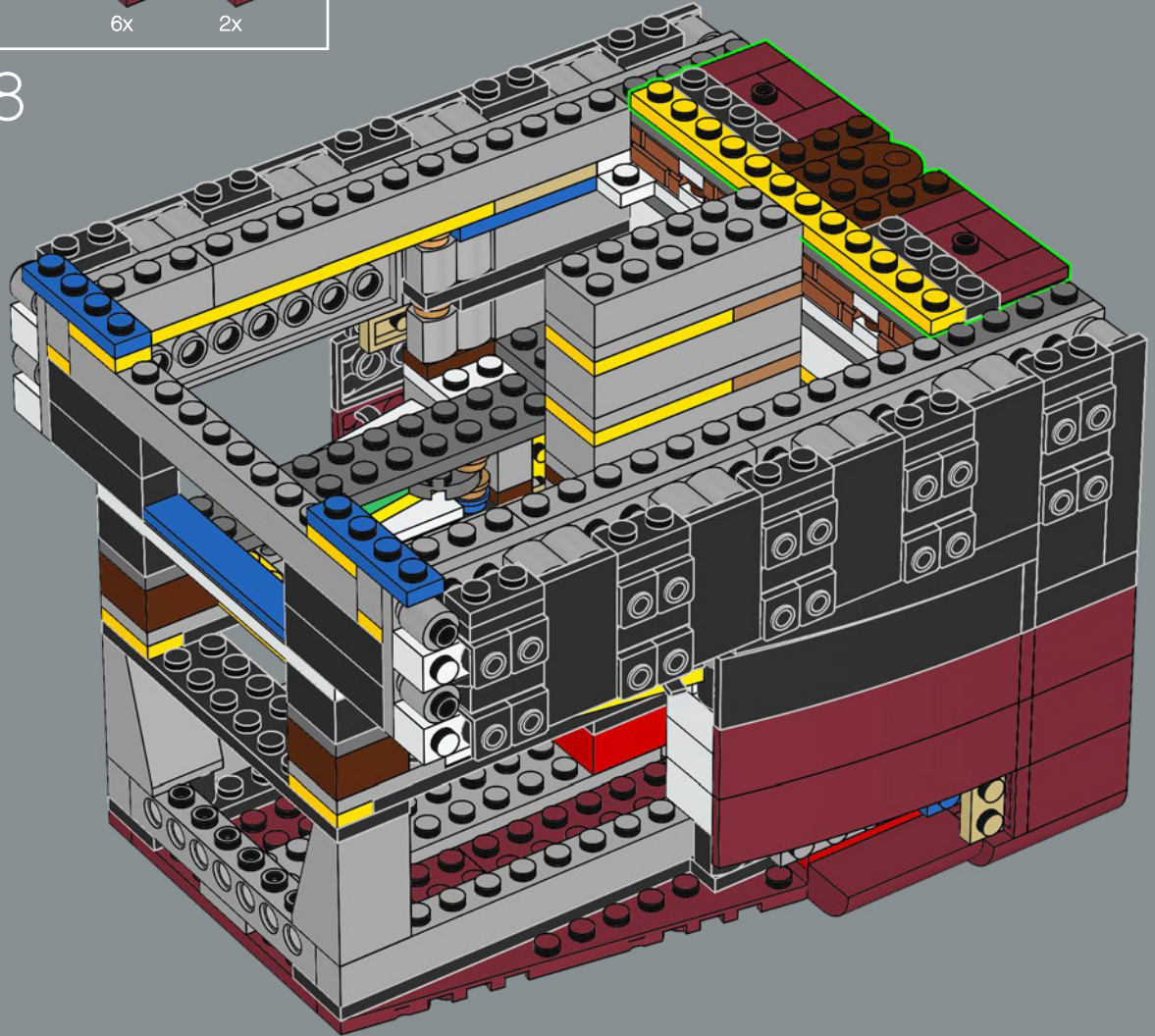



219

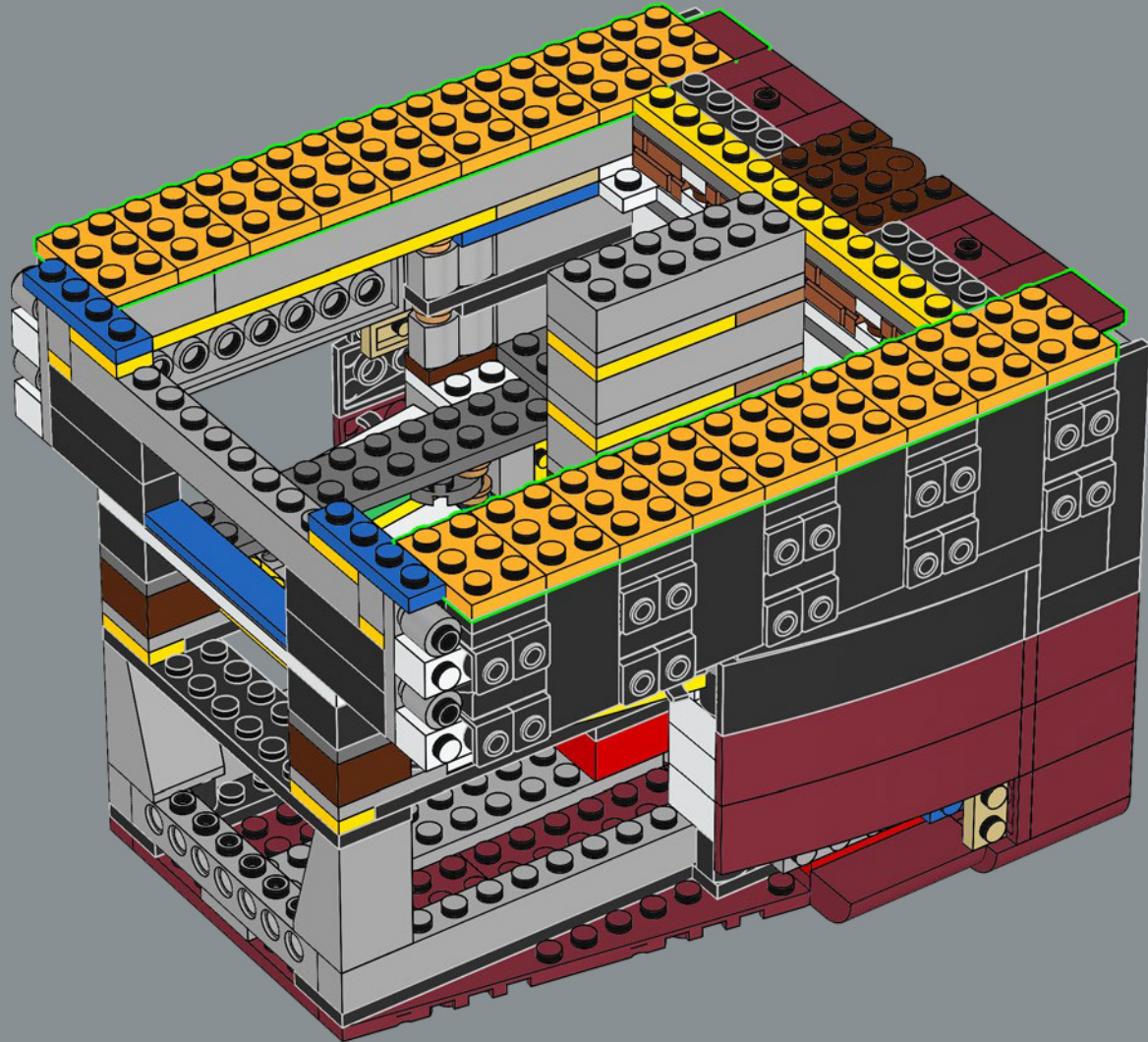

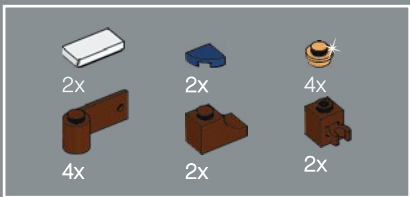

220

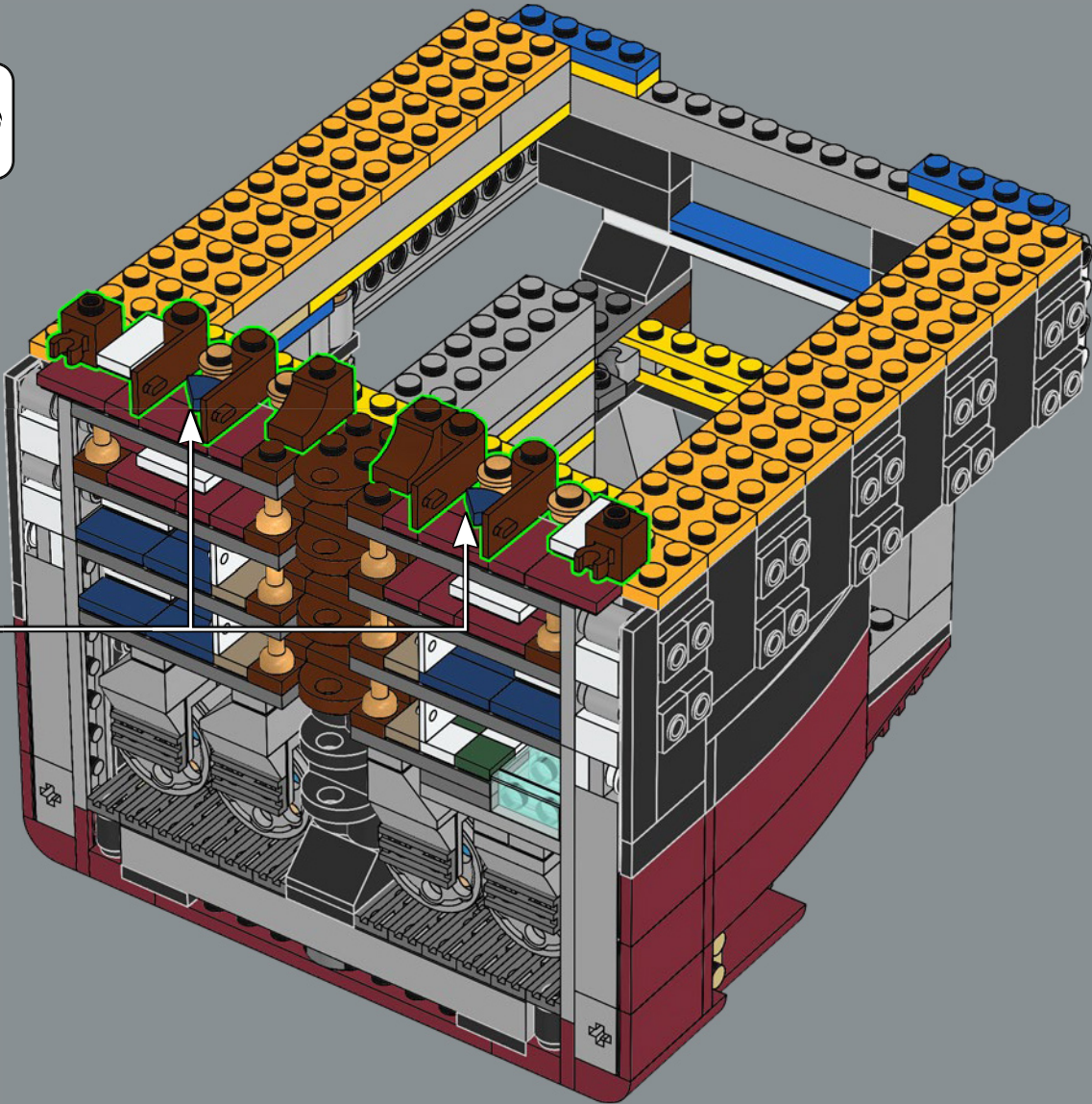

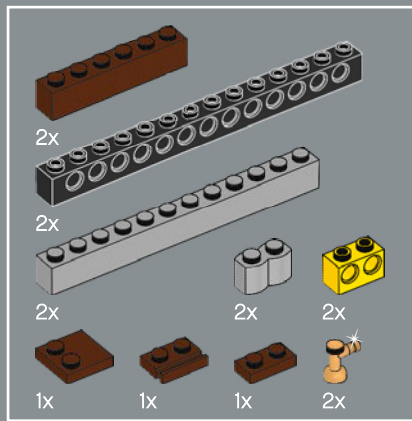

221

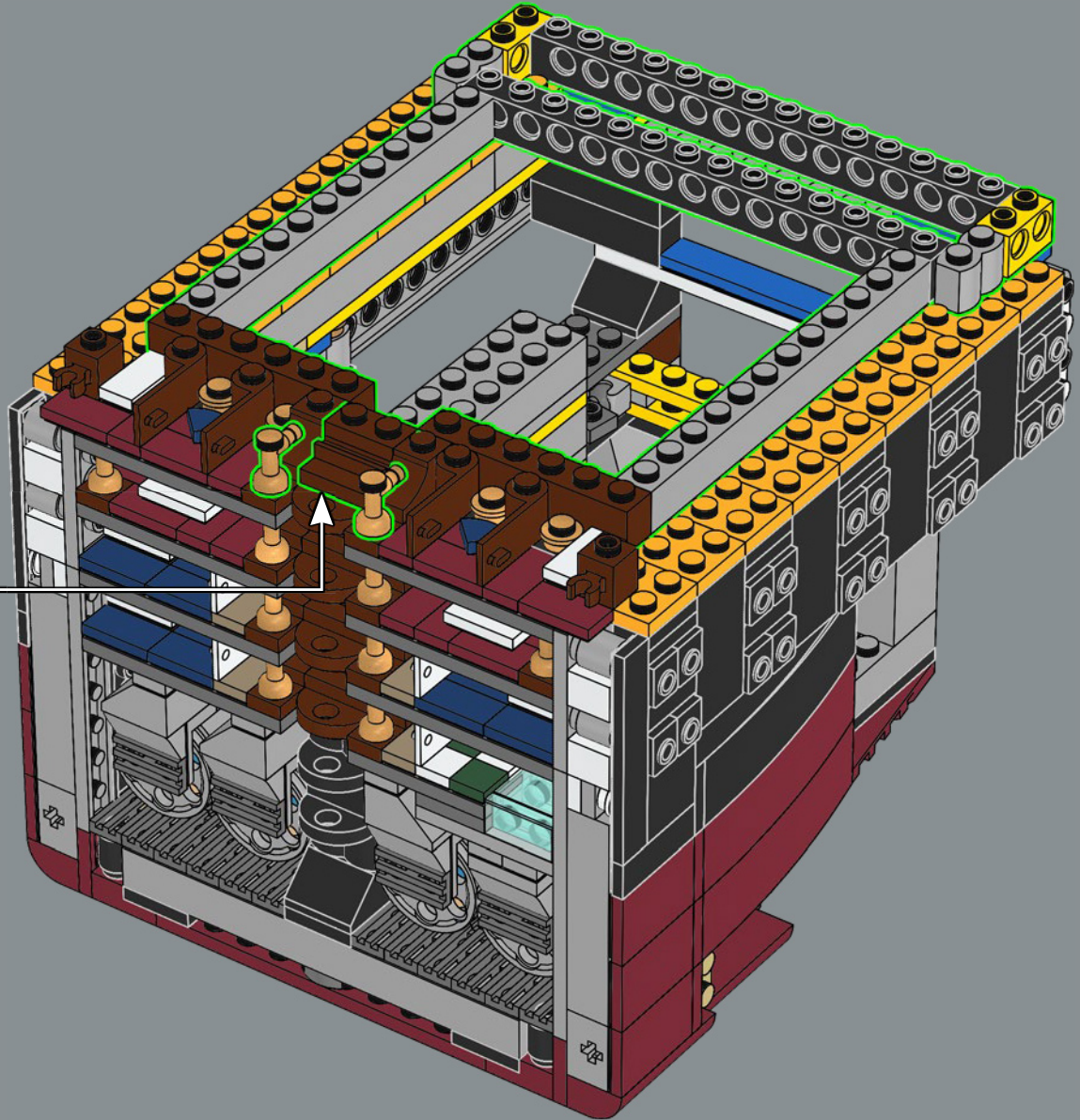
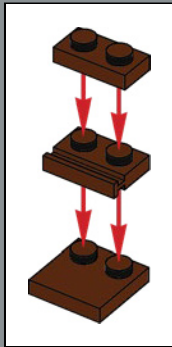

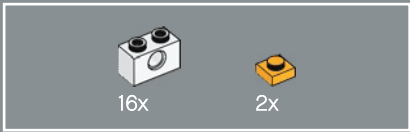

222

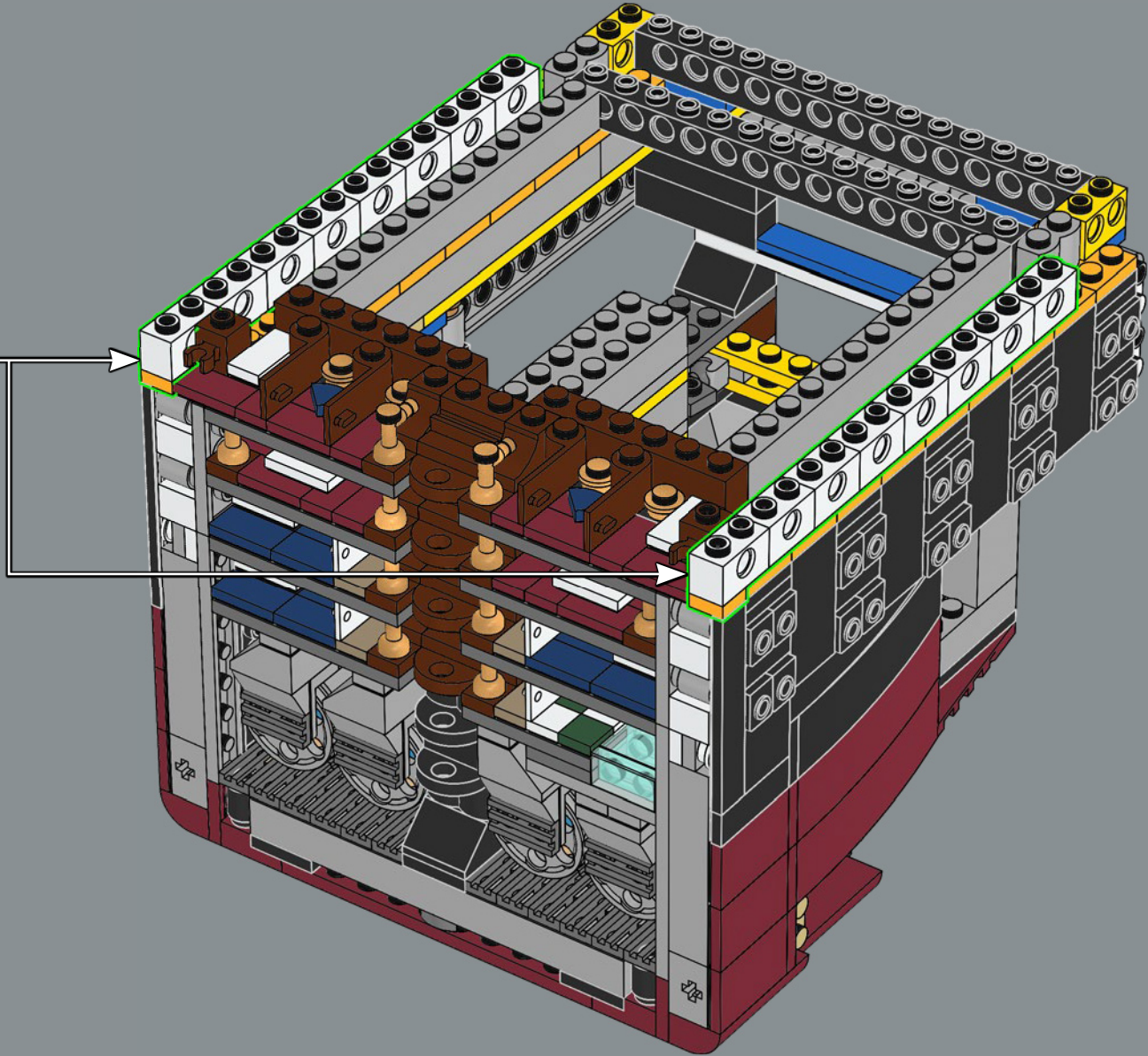
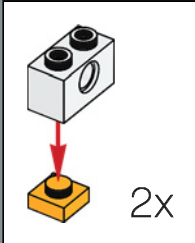

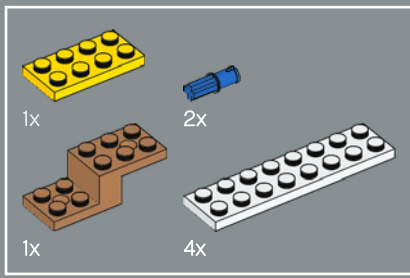

223

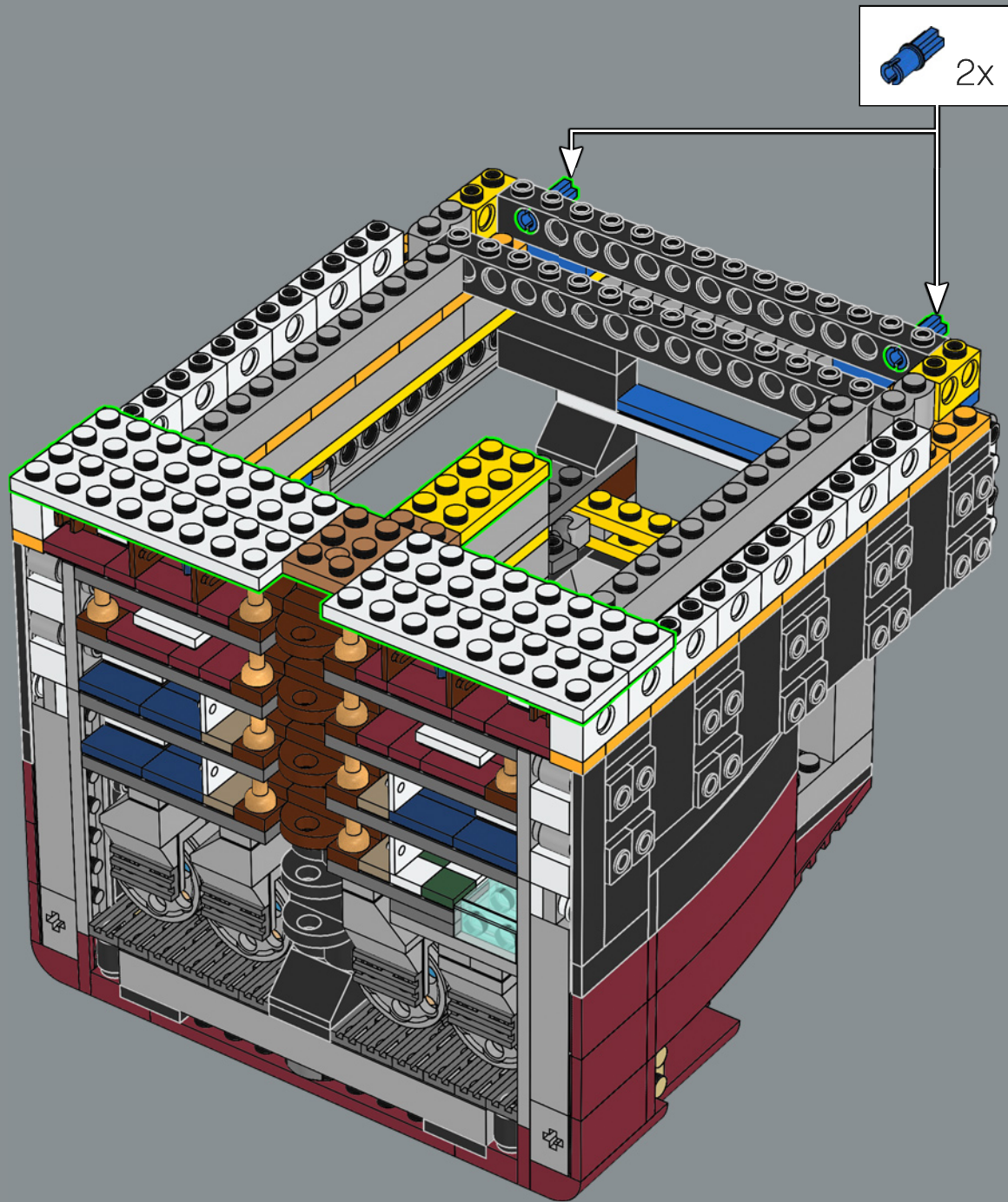

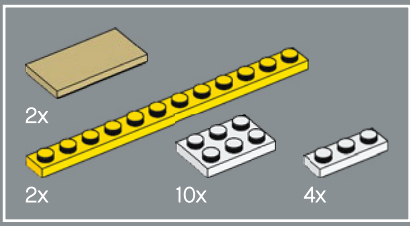

224

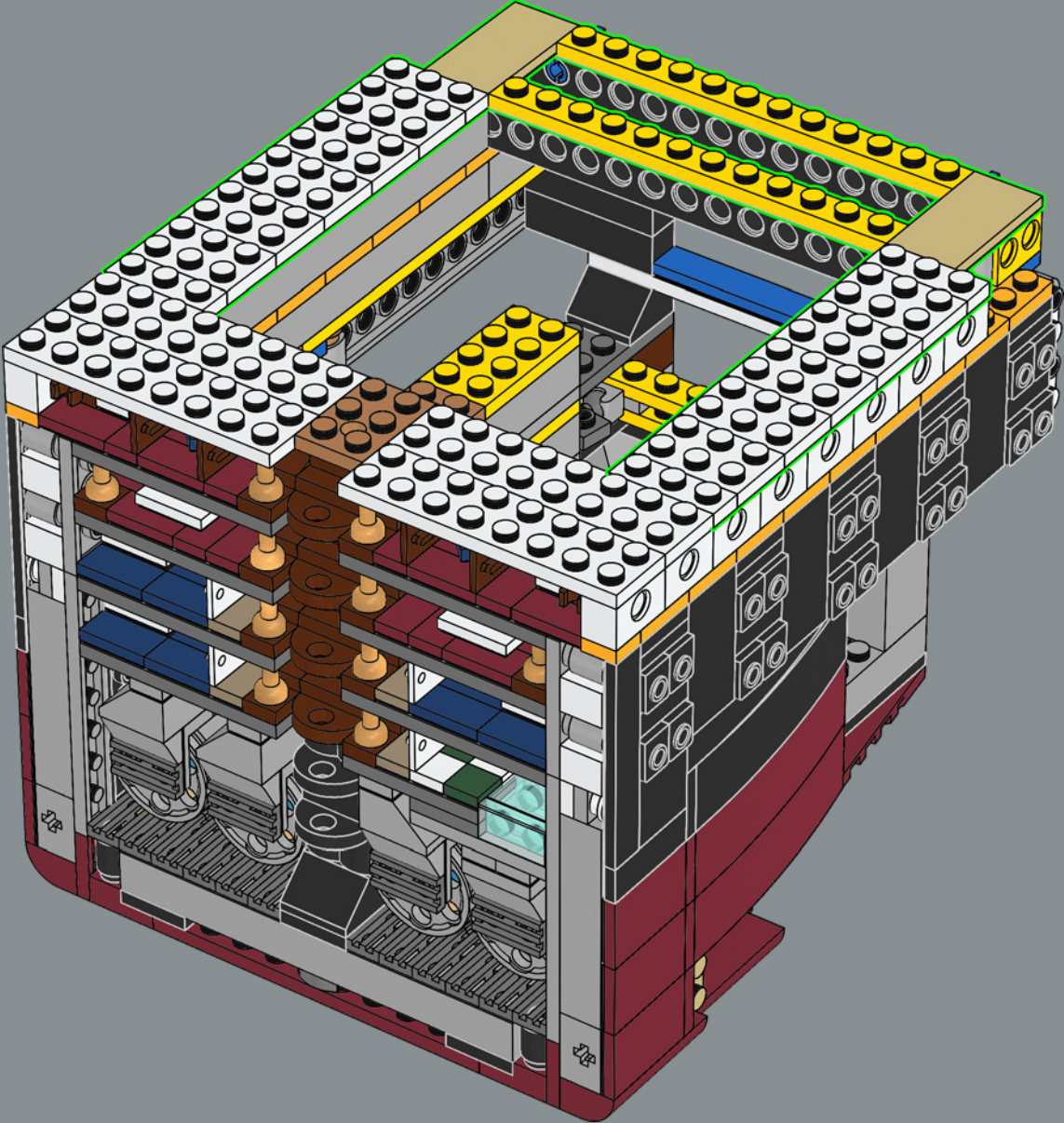

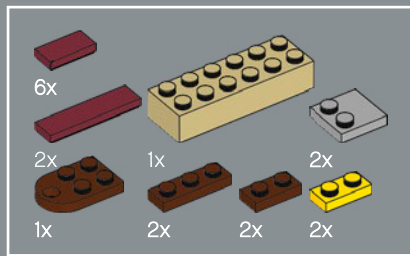

225

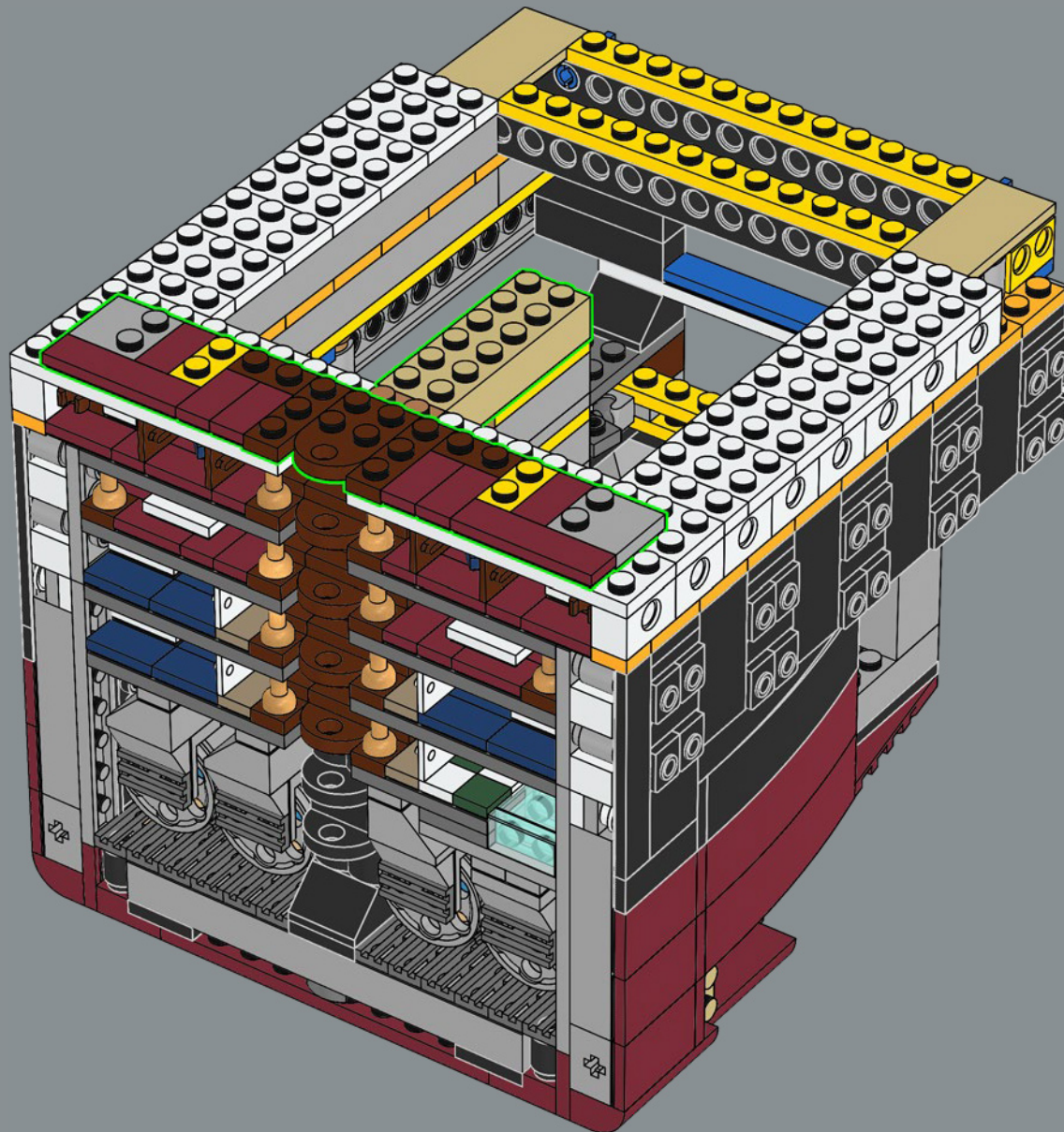

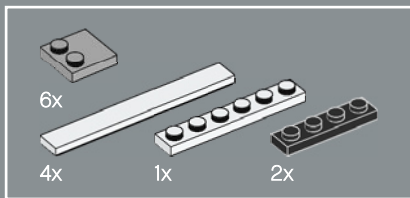

226

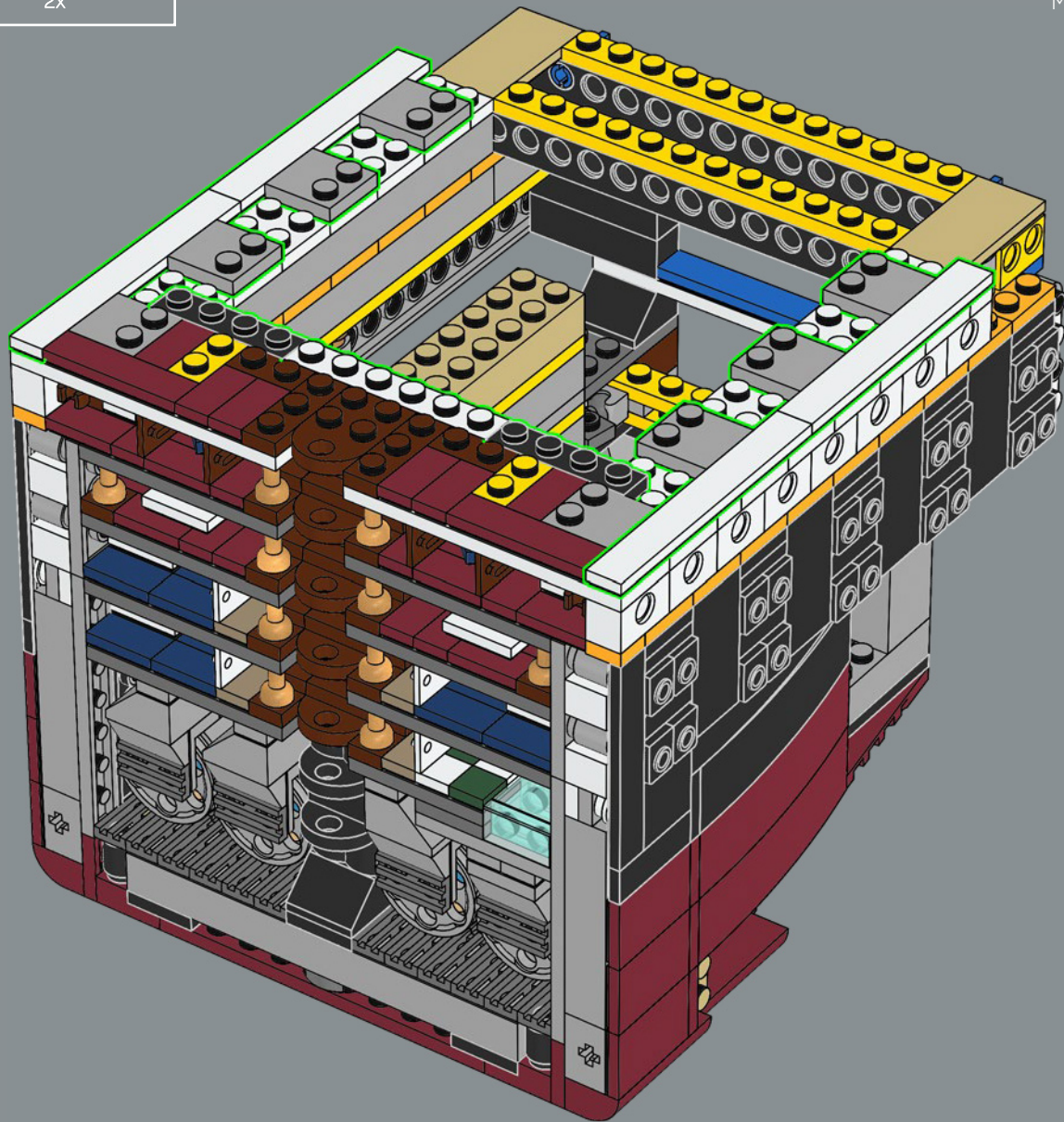

Las siglas RMS de RMS *Titanic* corresponden a *Royal Mail Ship* ("Buque de Royal Mail"); en este primer viaje, el barco transportaba un gran cargamento de correo para la empresa Royal Mail británica y también para USPS, el servicio postal de los Estados Unidos.

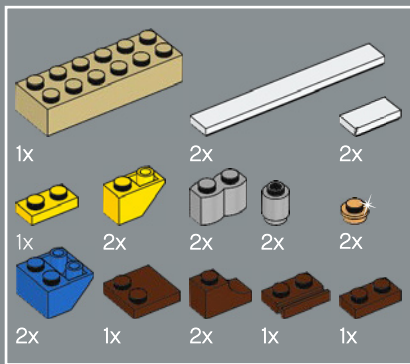

227

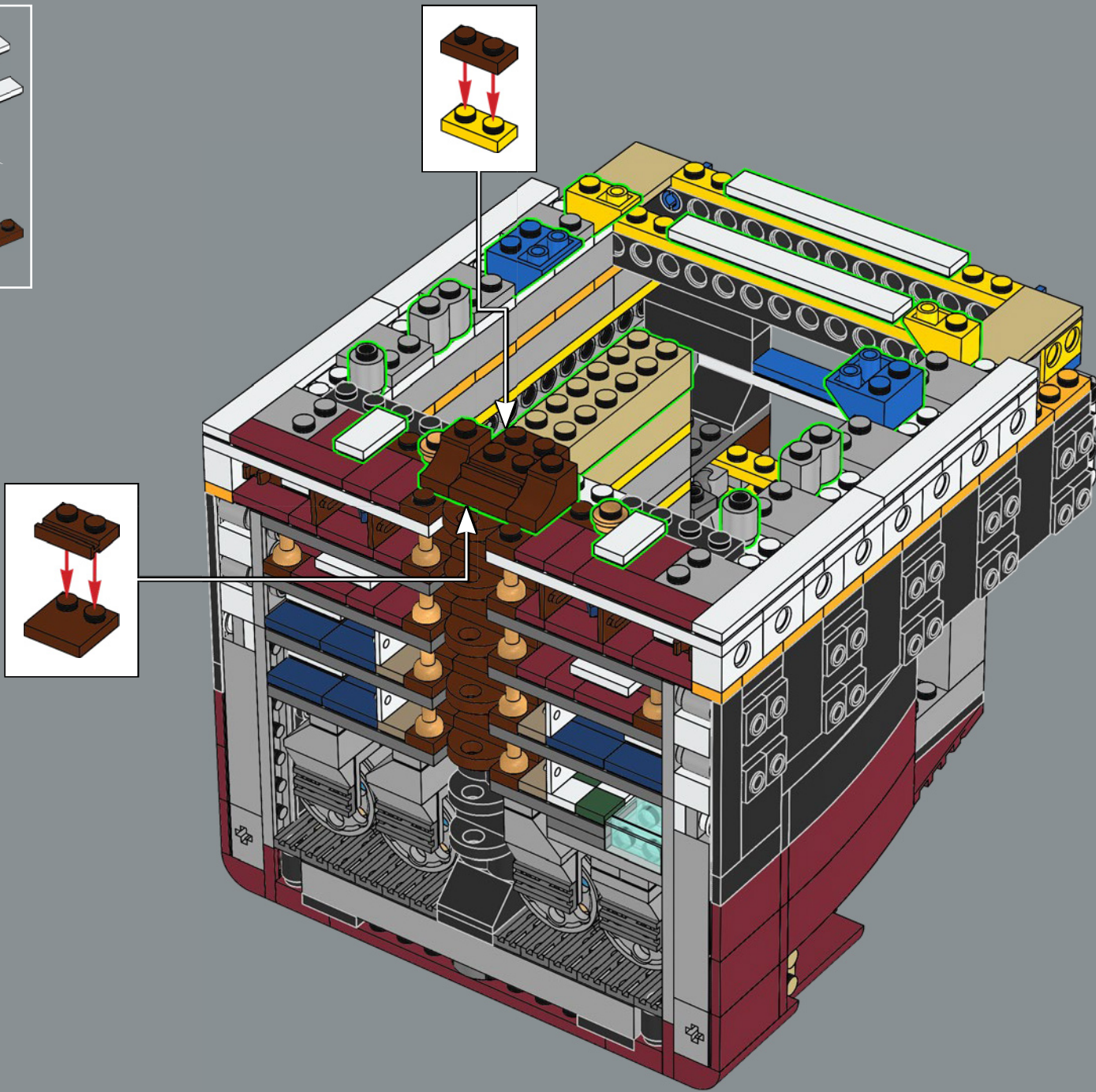

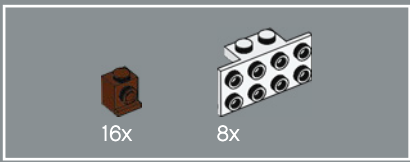

228

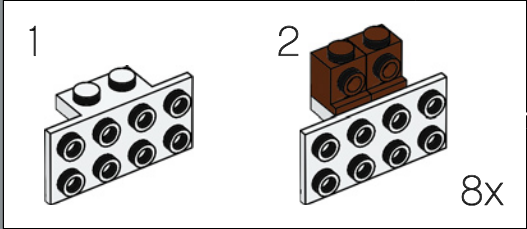
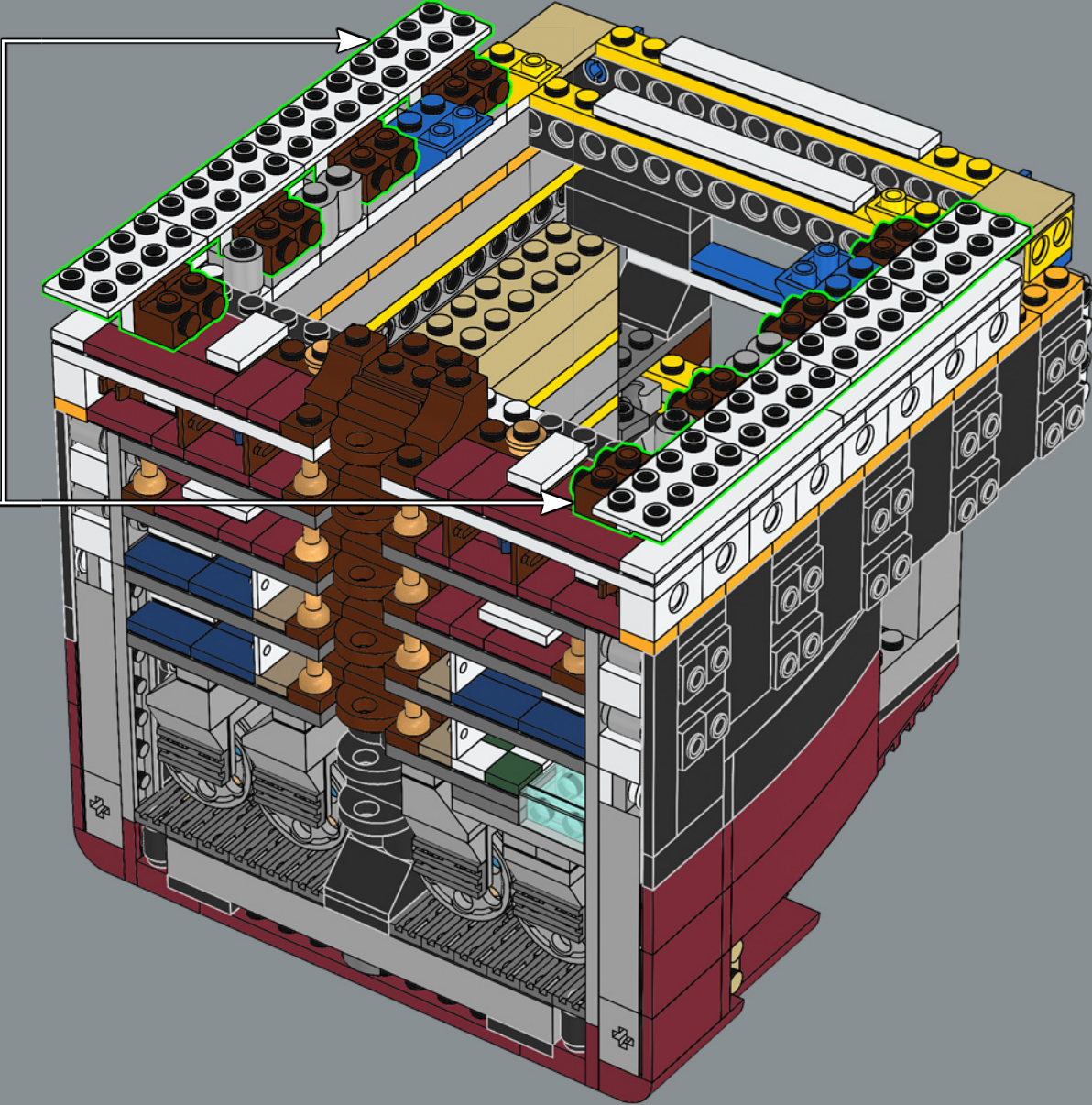

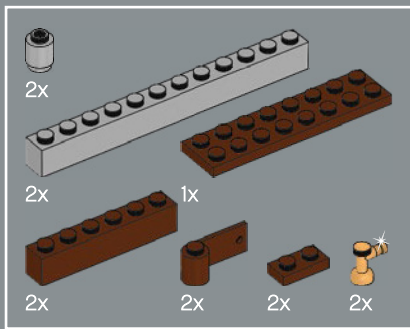

229

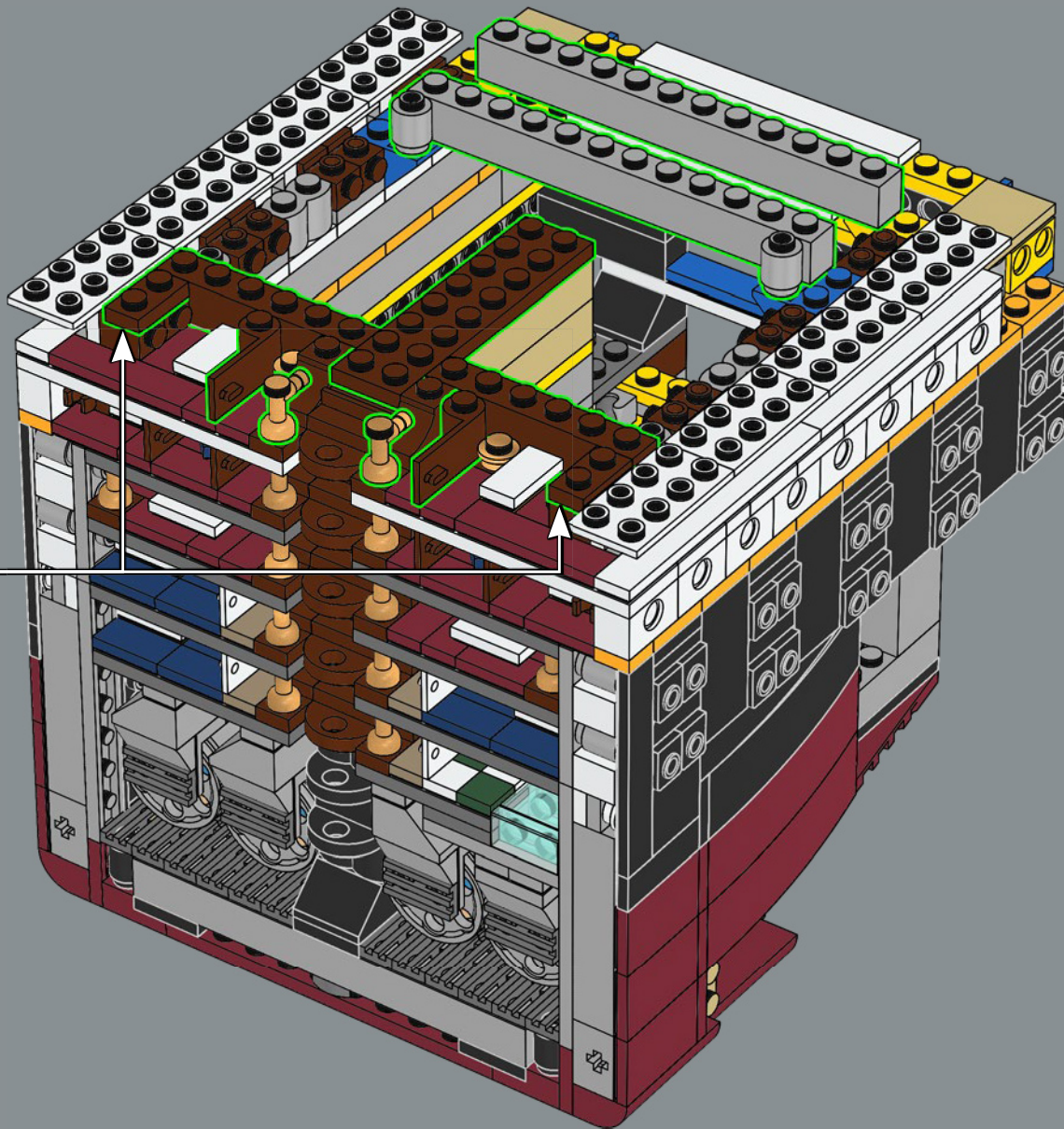

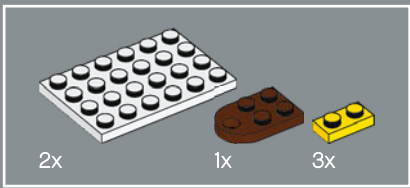

230

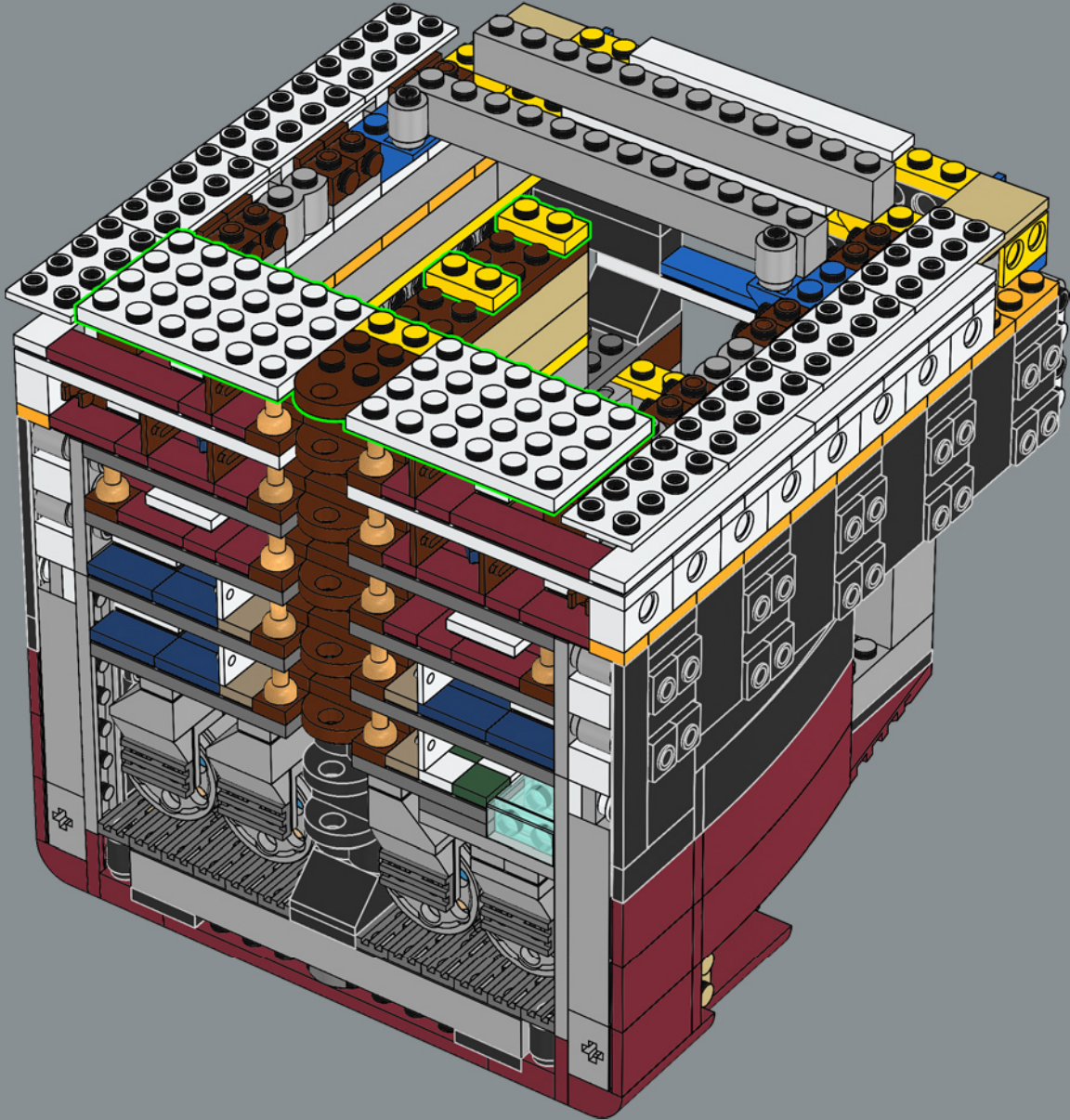

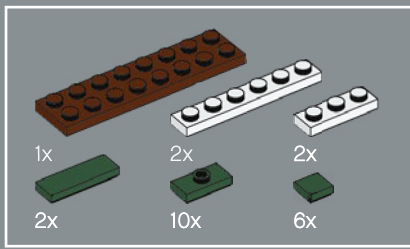

231

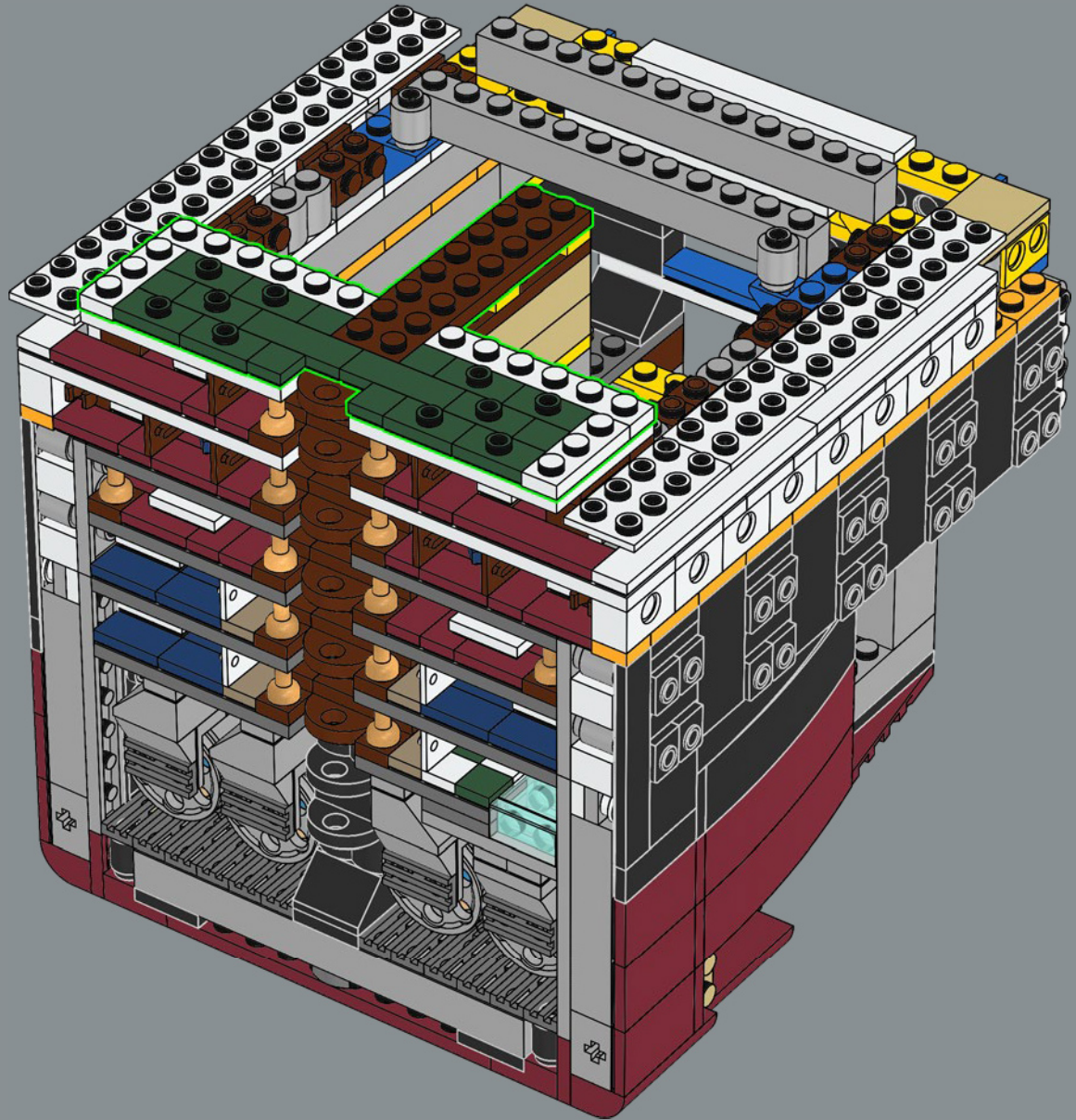

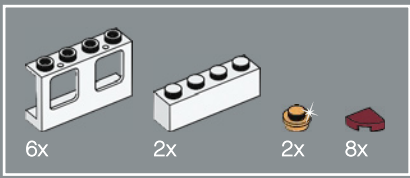

232

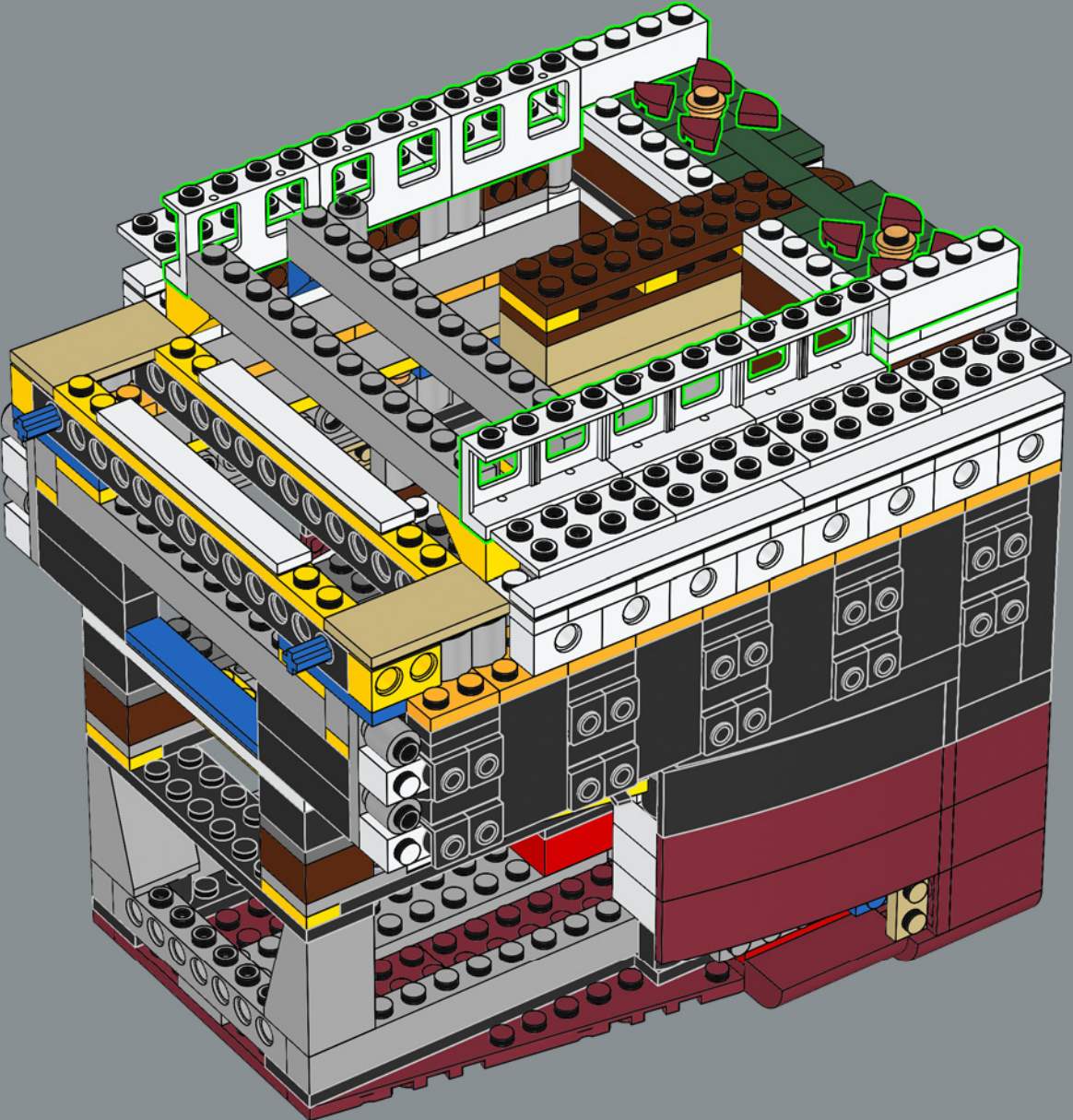

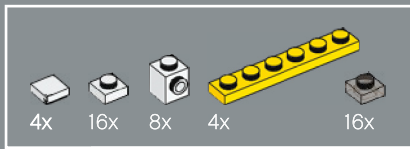

233

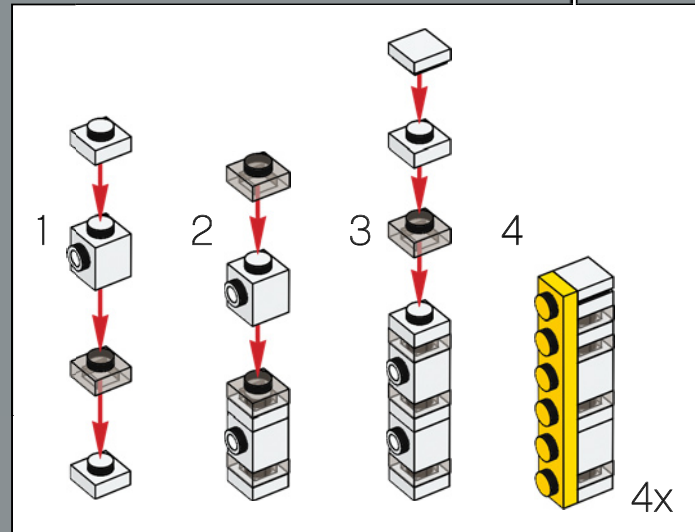
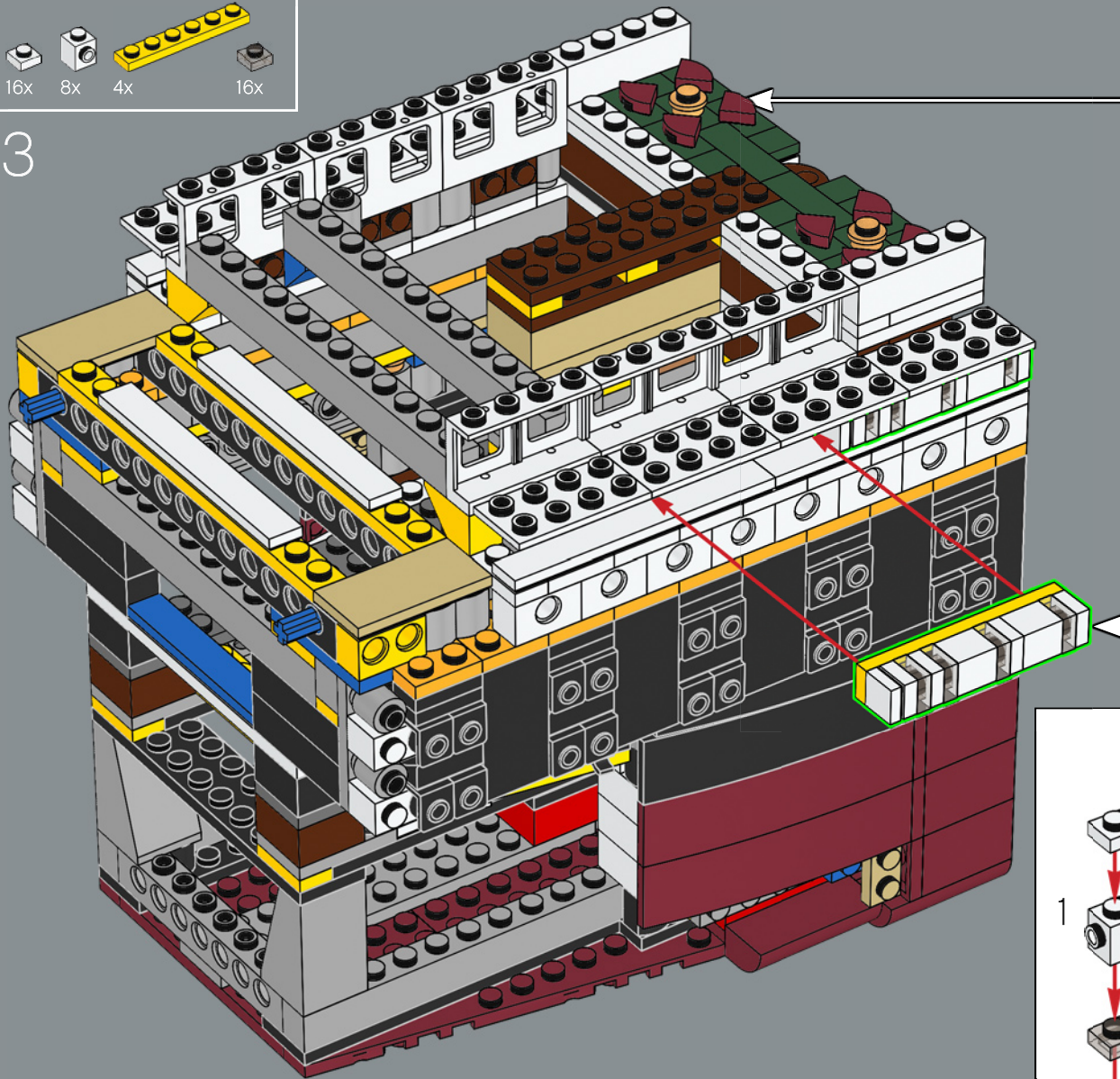

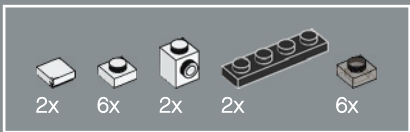

234

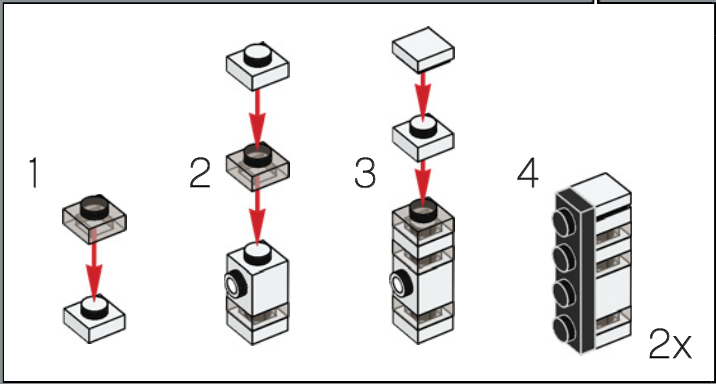
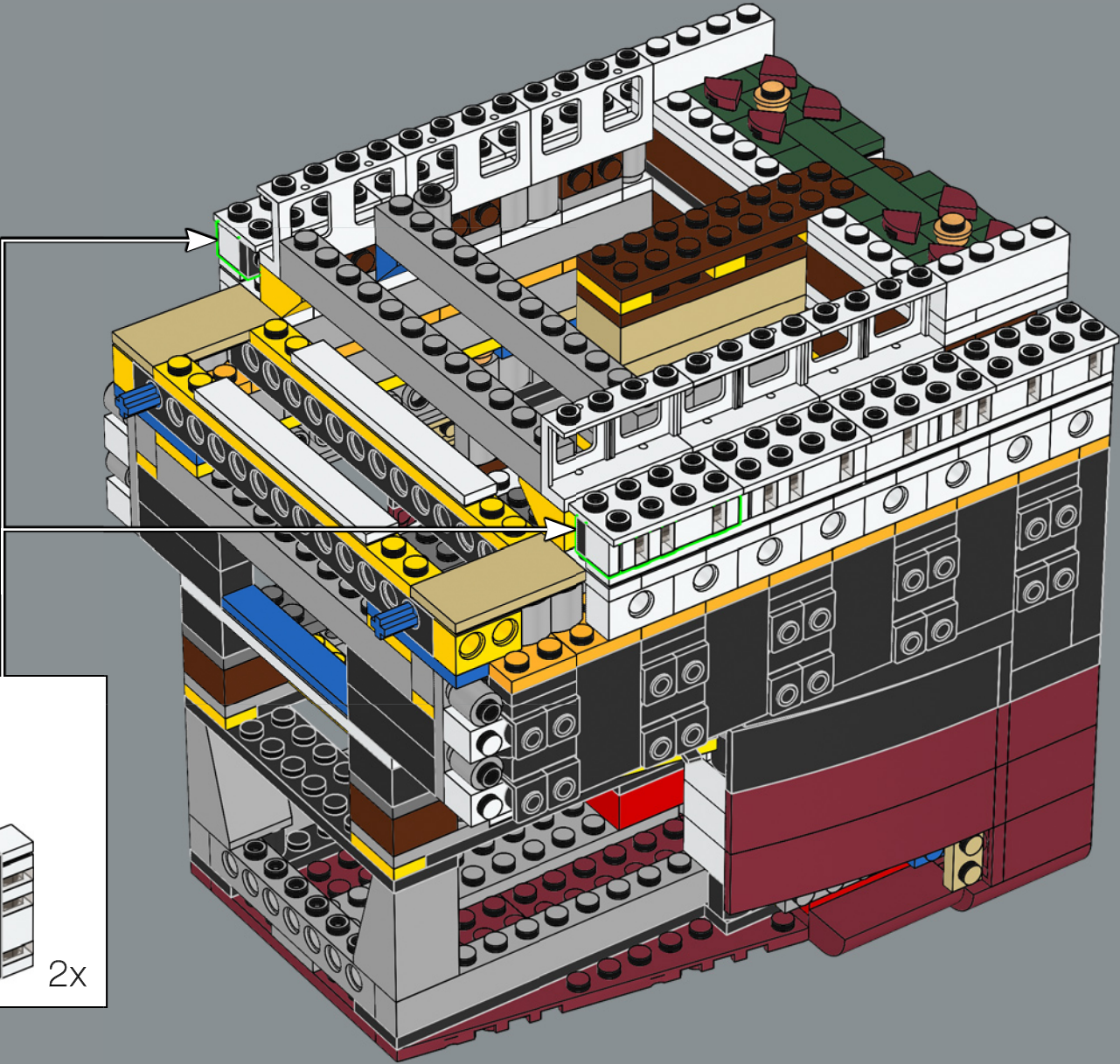

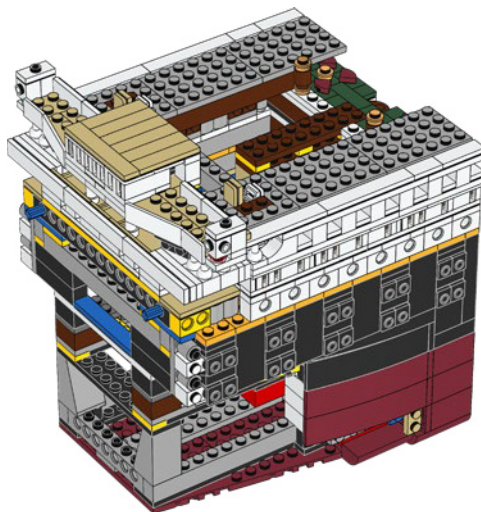
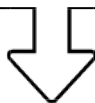

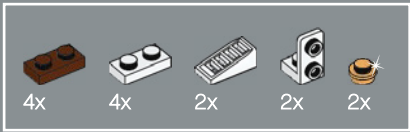

235

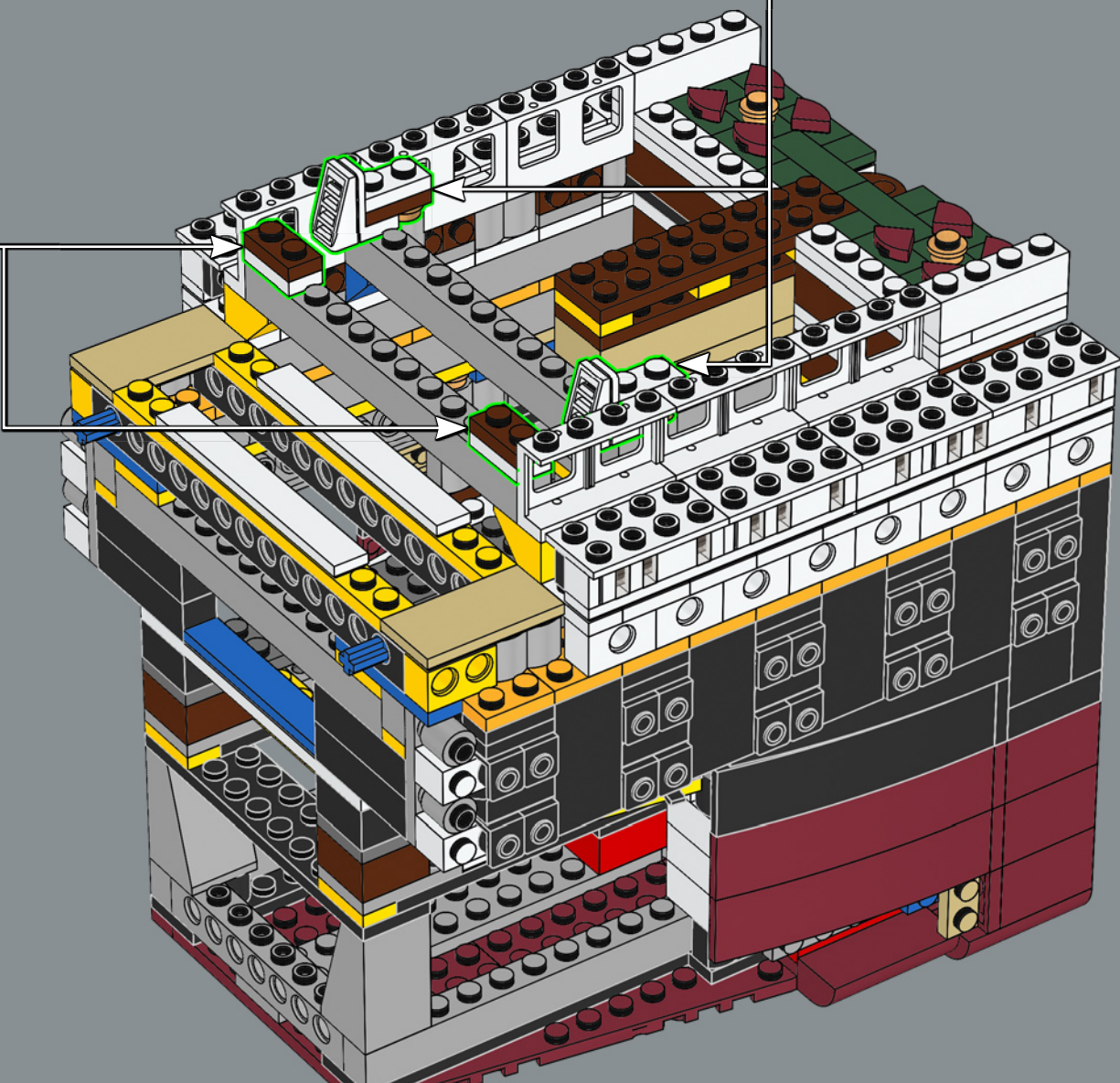
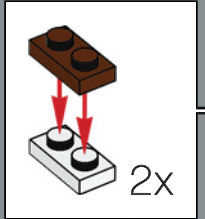
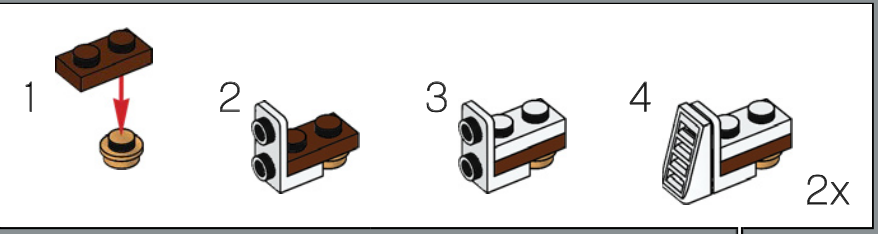

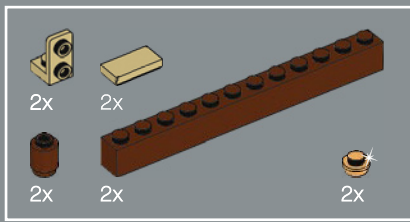

236

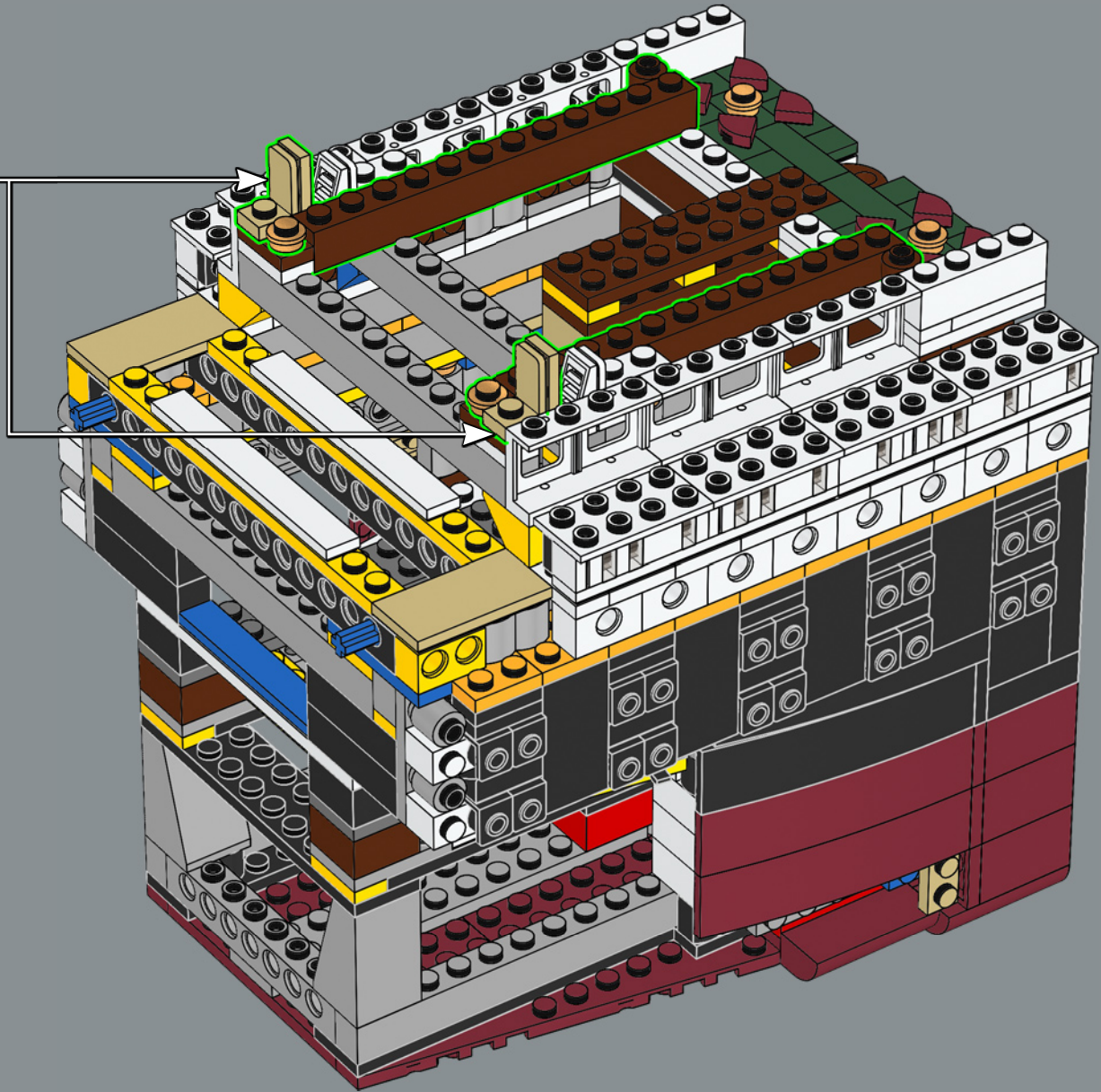
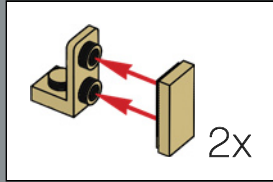

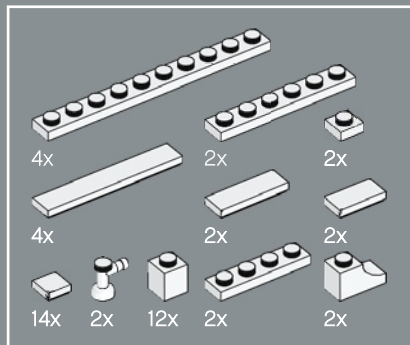
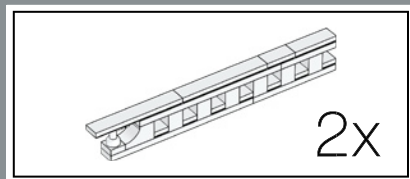

237

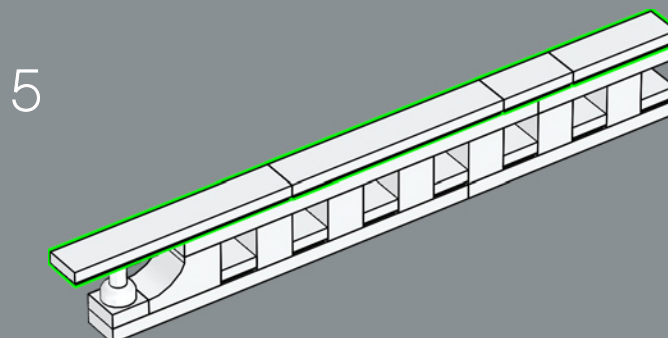
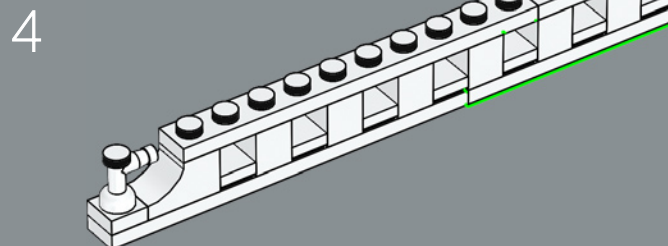
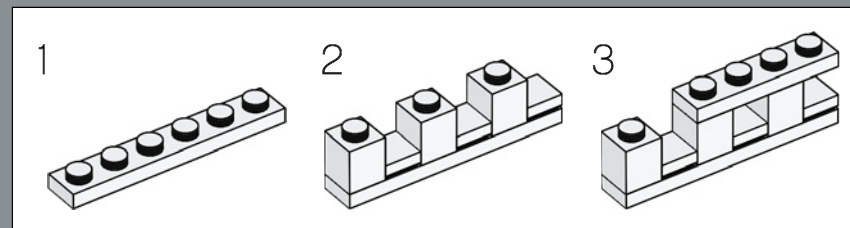
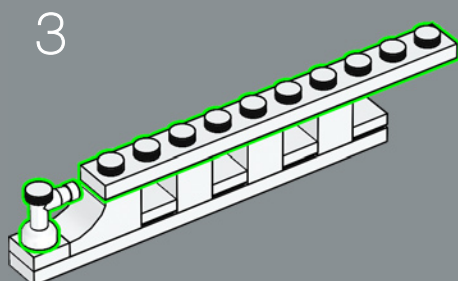
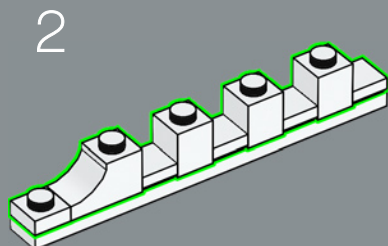
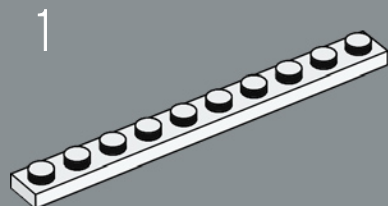

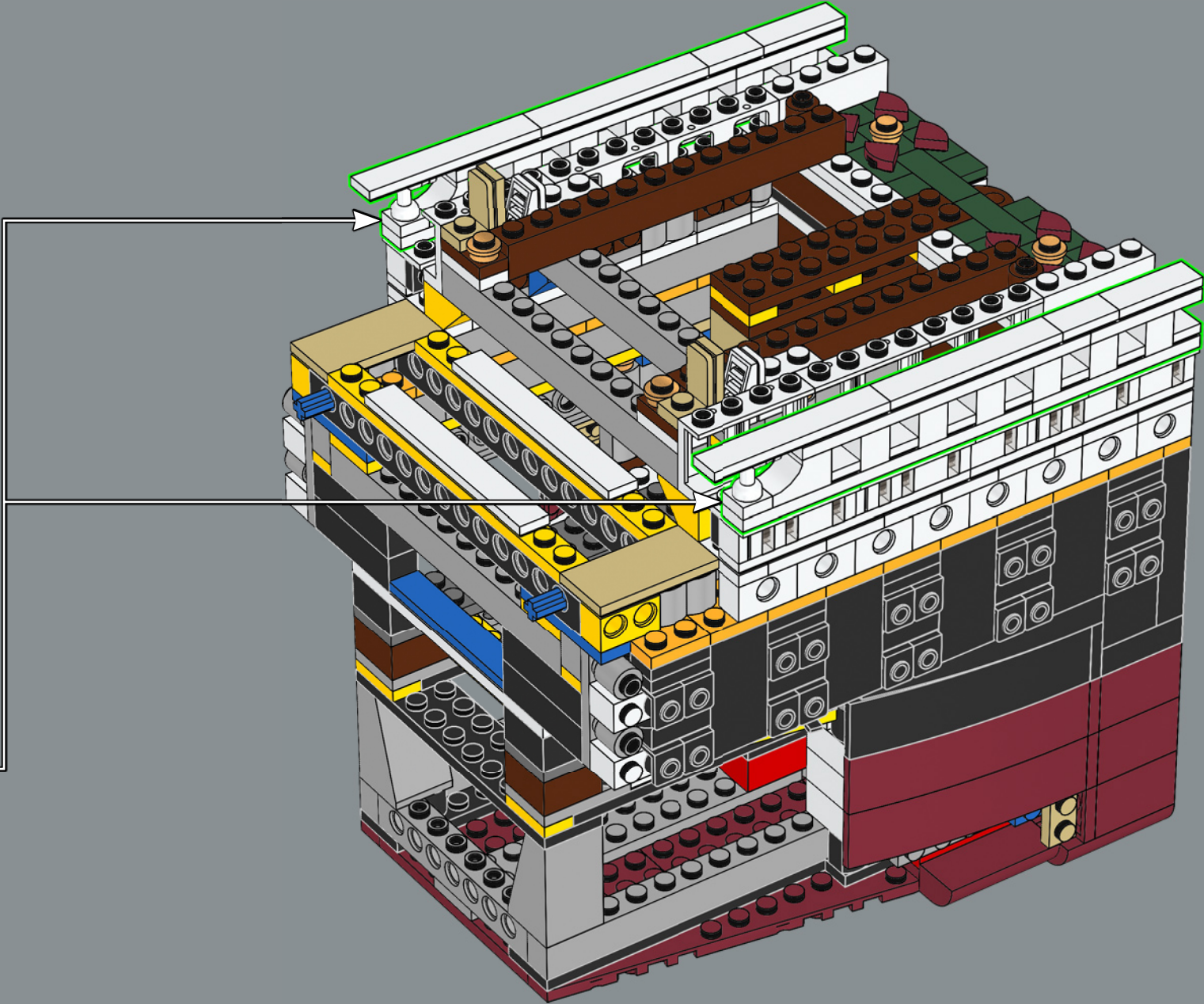

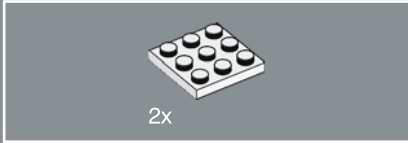
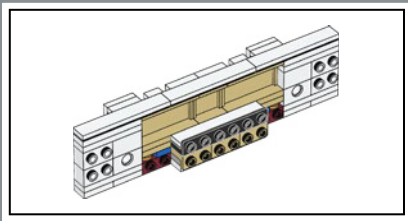

238

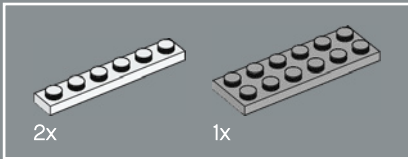
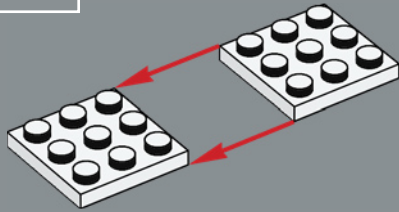

239

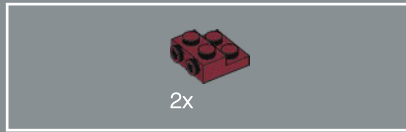
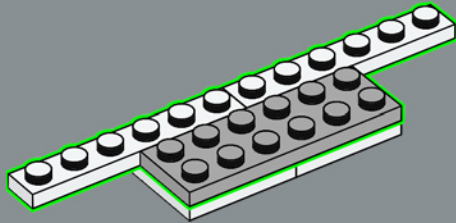

240

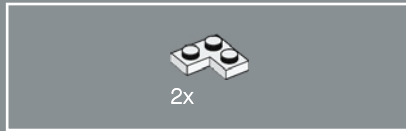
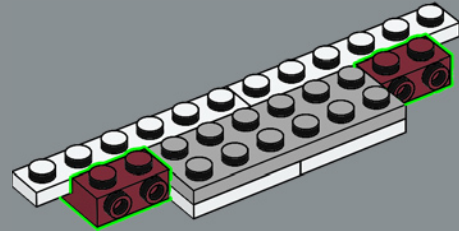

241

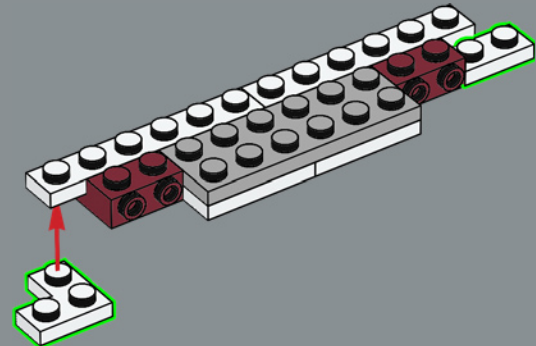

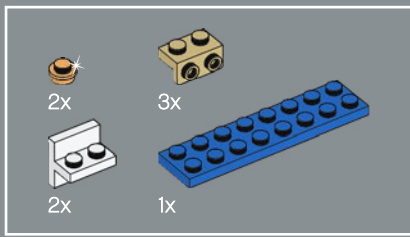

242

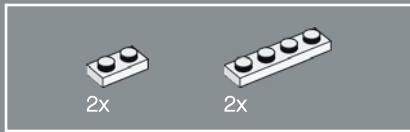
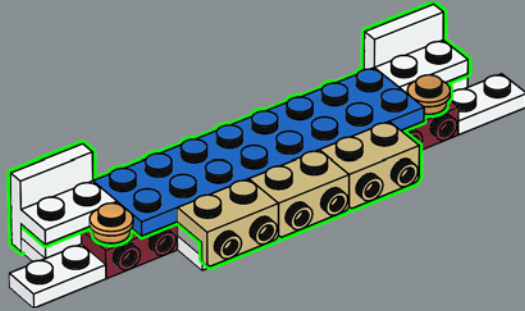

243

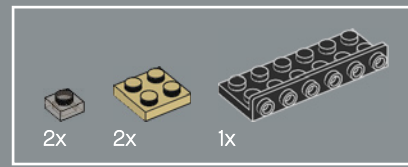
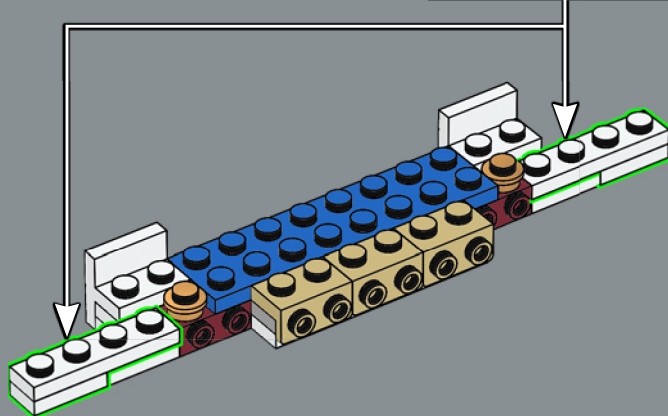
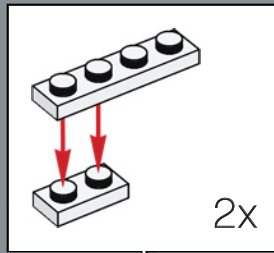

244

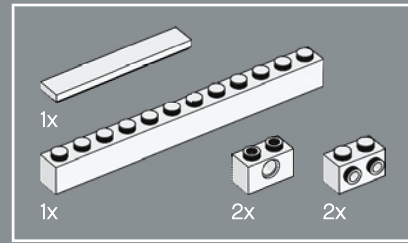
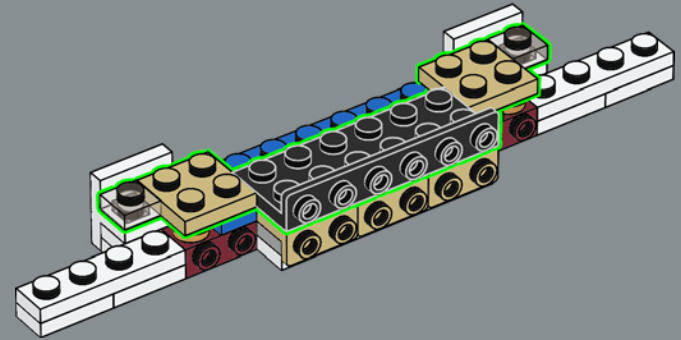

245

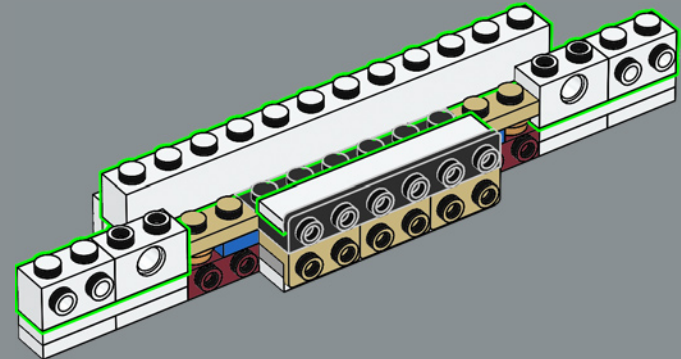

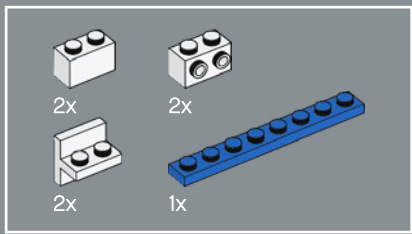

246

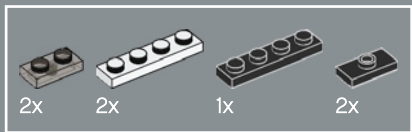
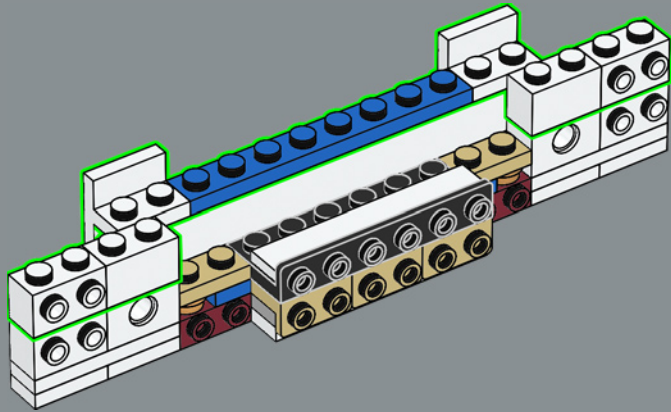

247

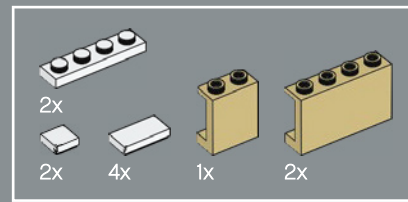
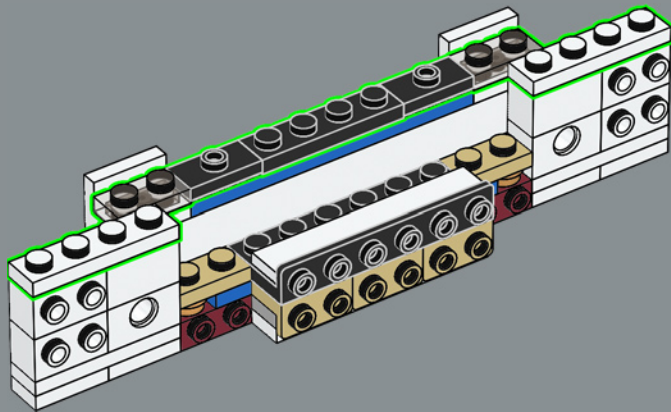

248

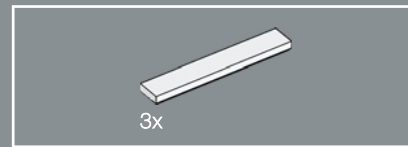
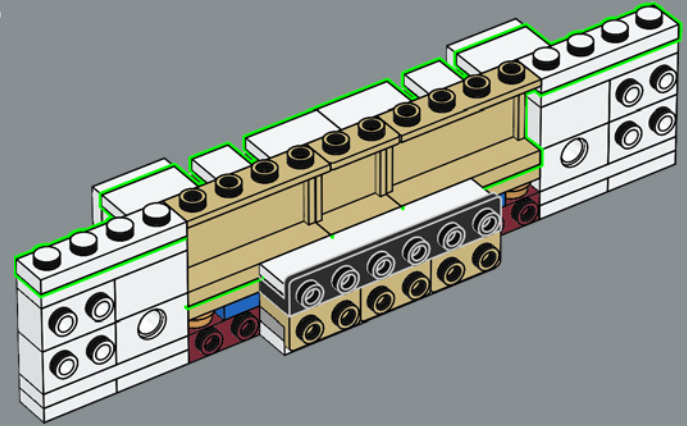

249

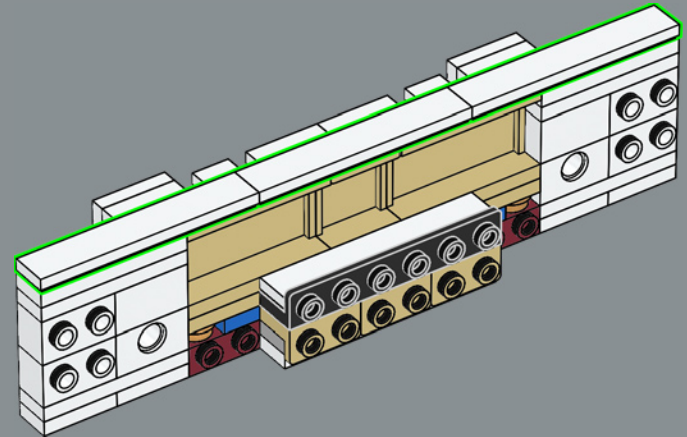

250

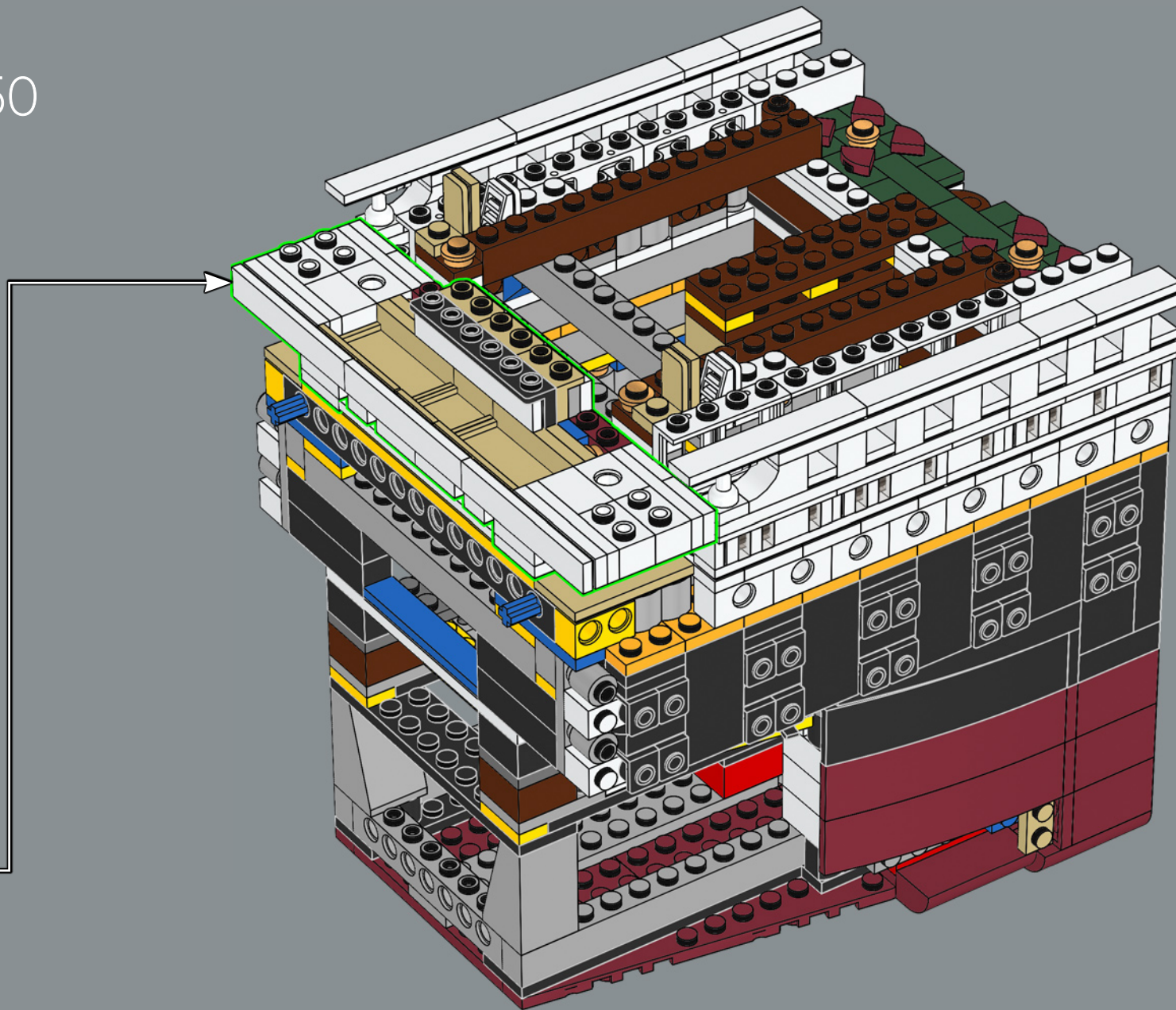

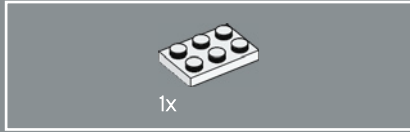
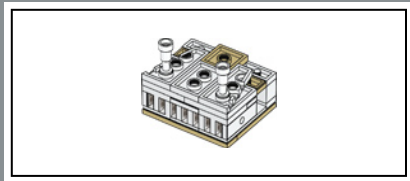

251

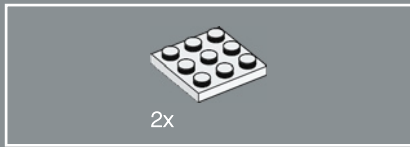

252

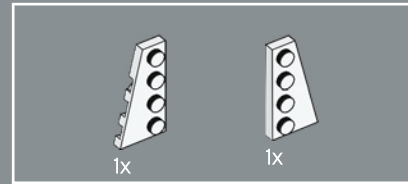
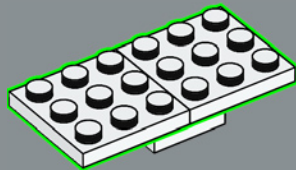

253

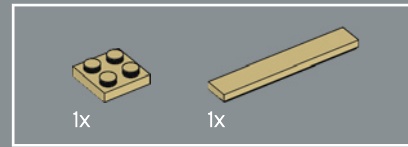
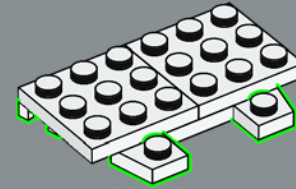

254

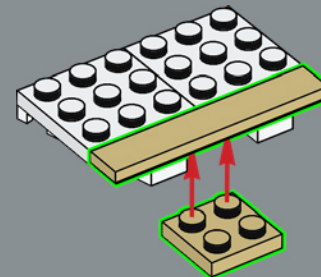

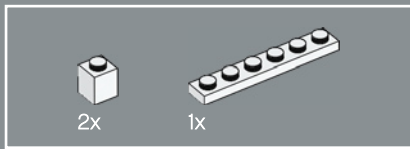

255

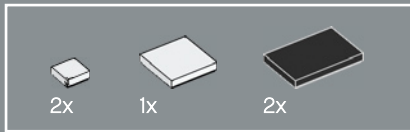
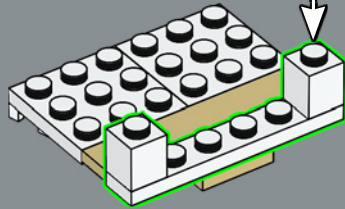
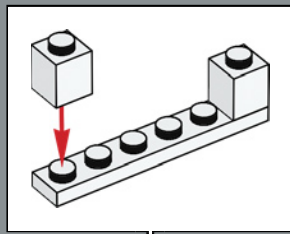

256

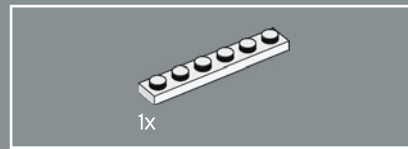
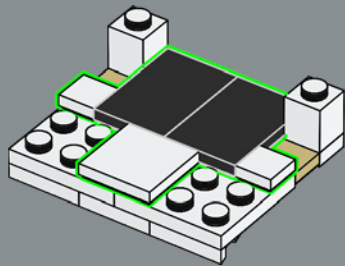

257

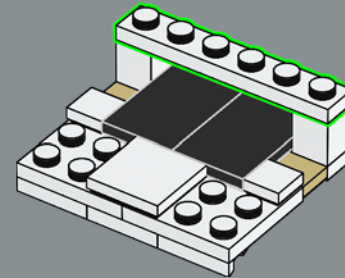

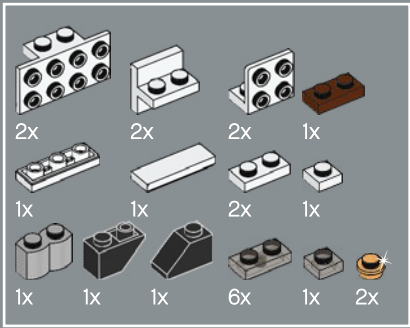

258

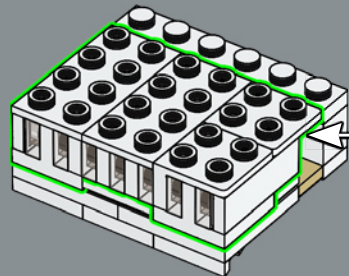
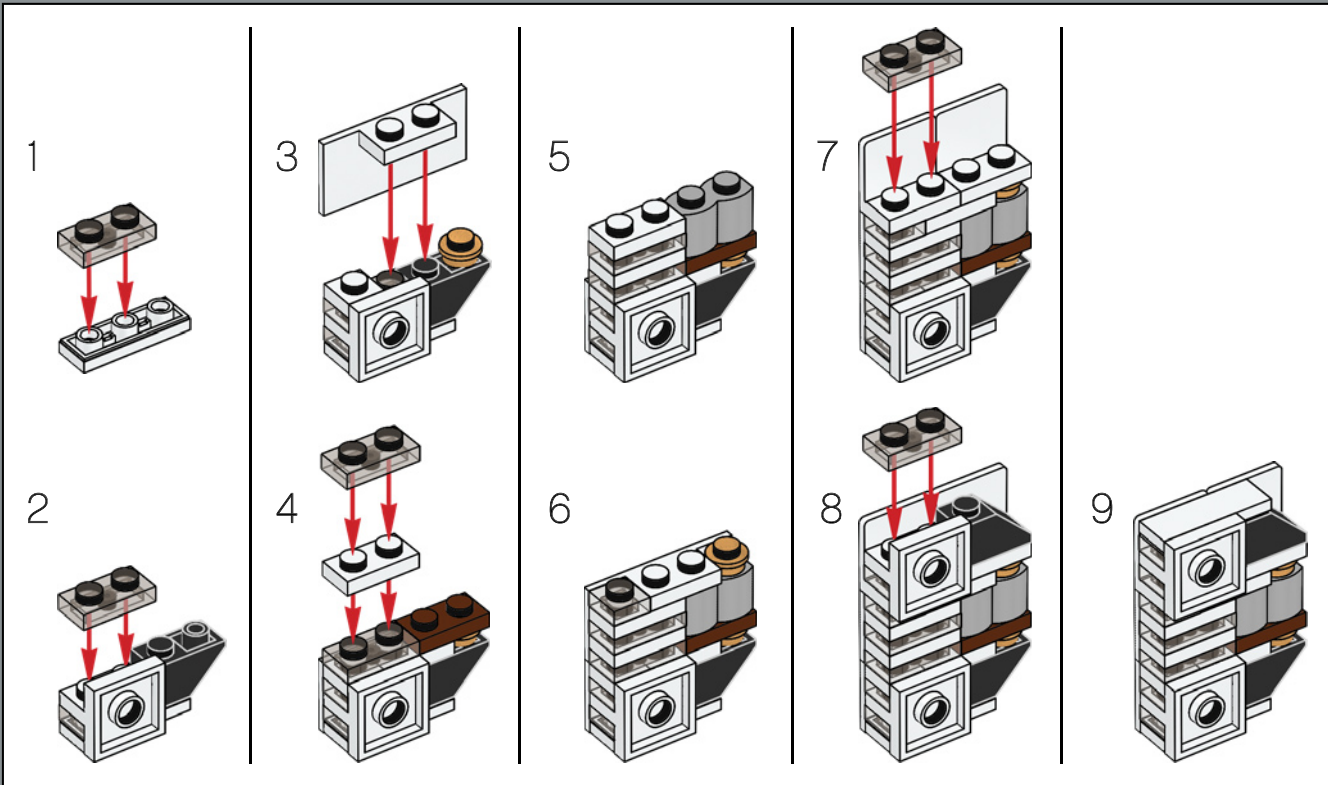

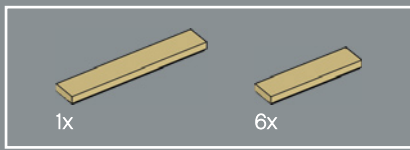

259

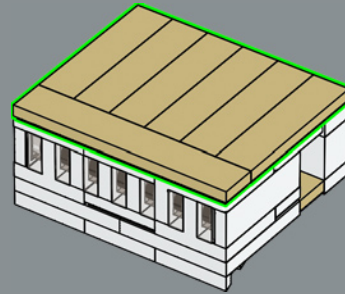

260

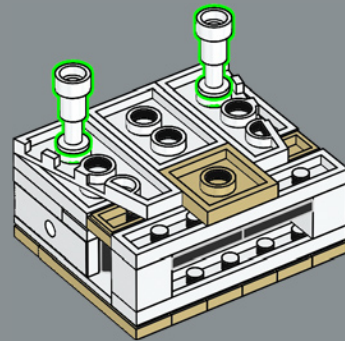

261

El puente se alza 2,4 m por encima de la cubierta y sobresalía por cada lado para poder controlar el barco durante el ataque.

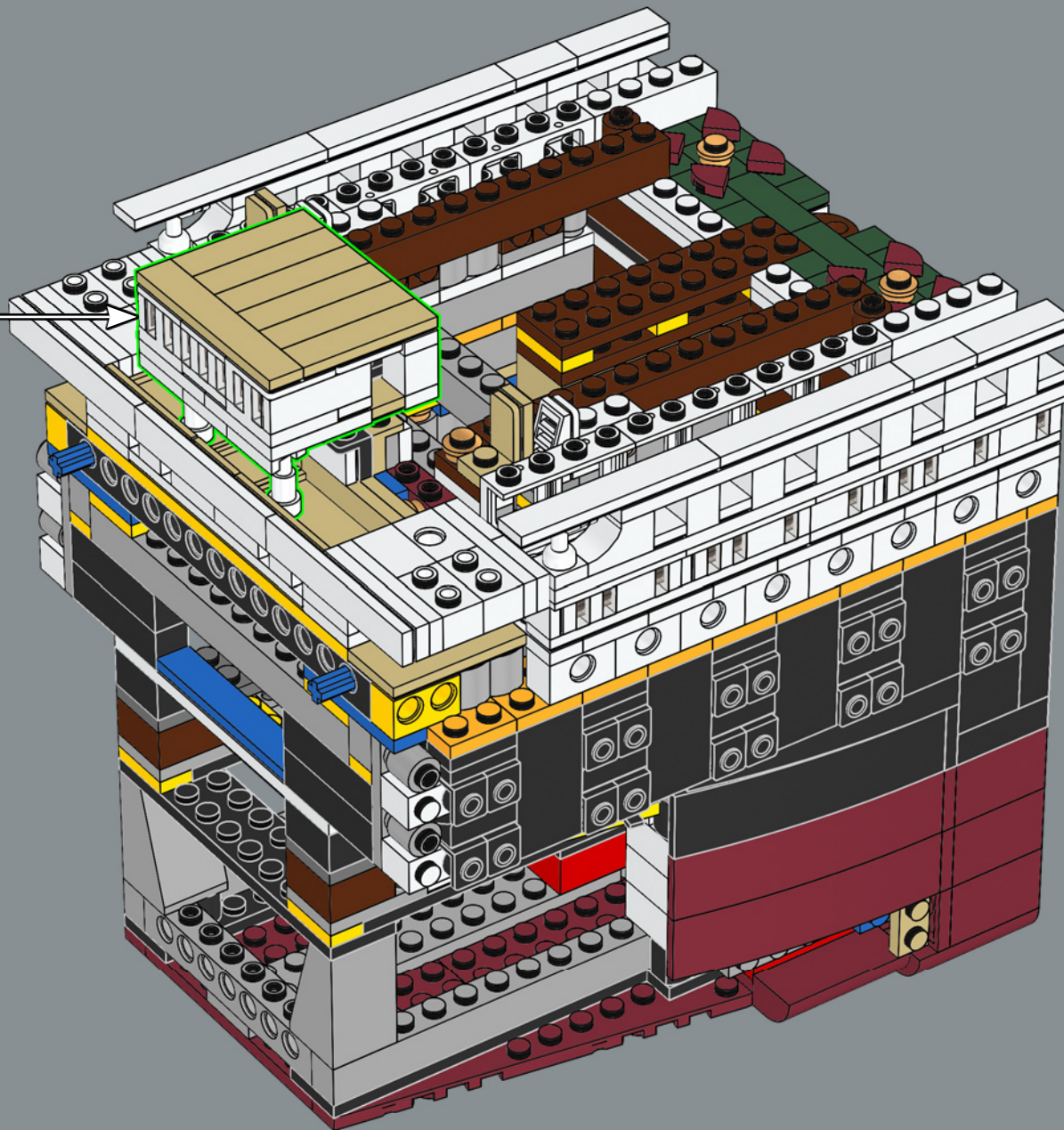



262

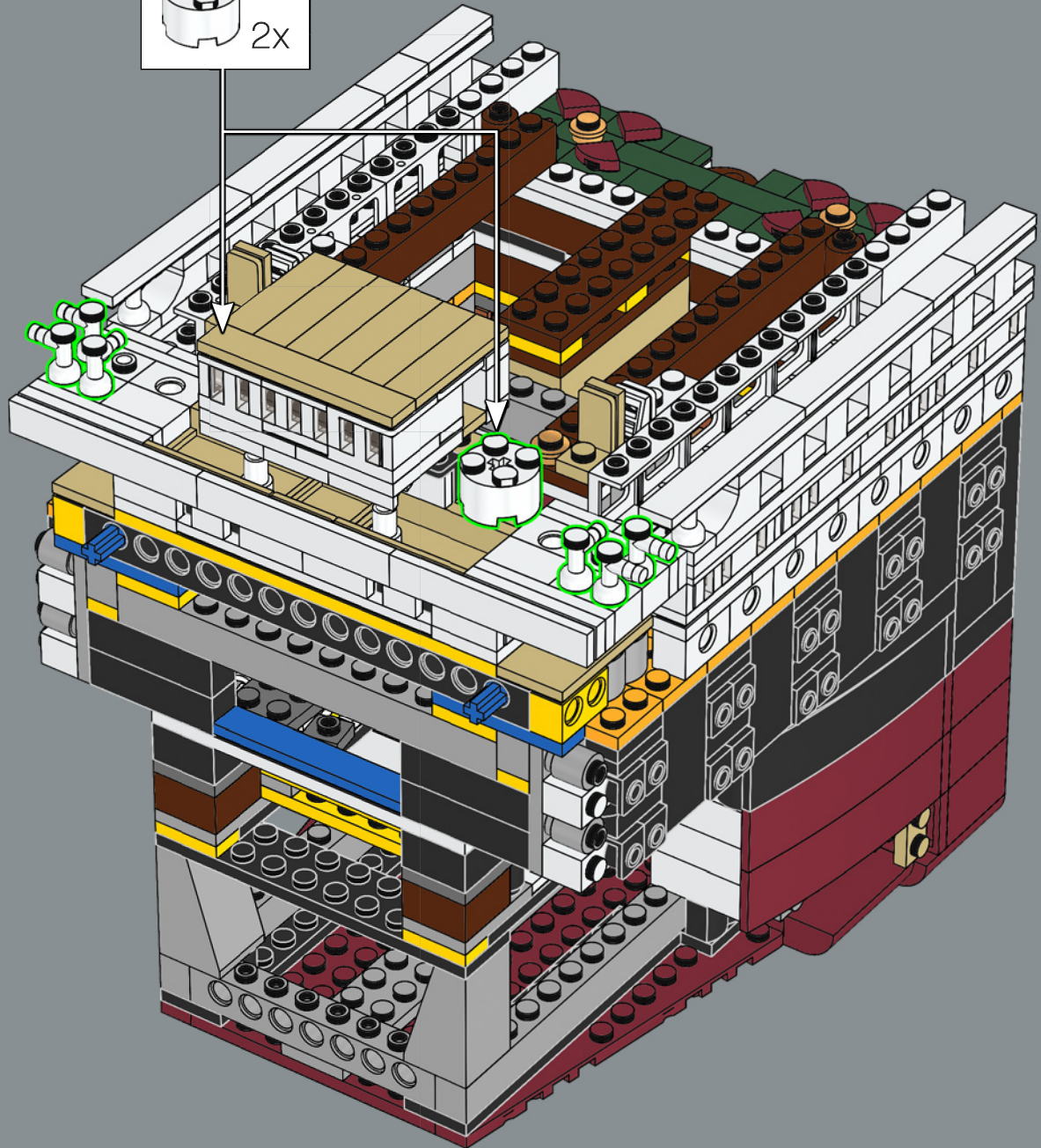
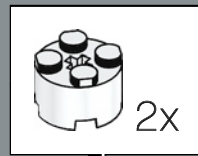

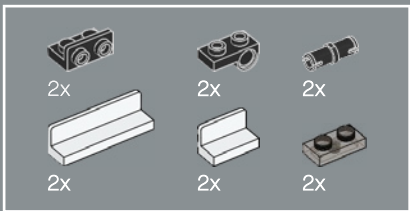

263

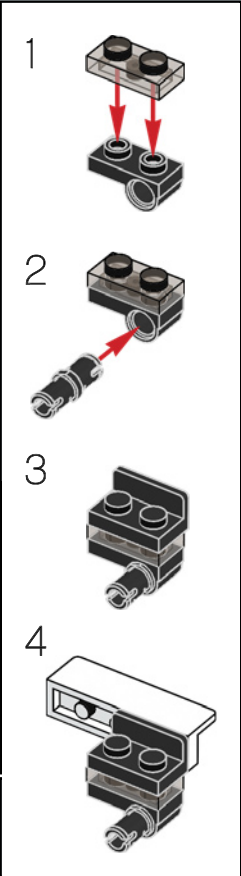
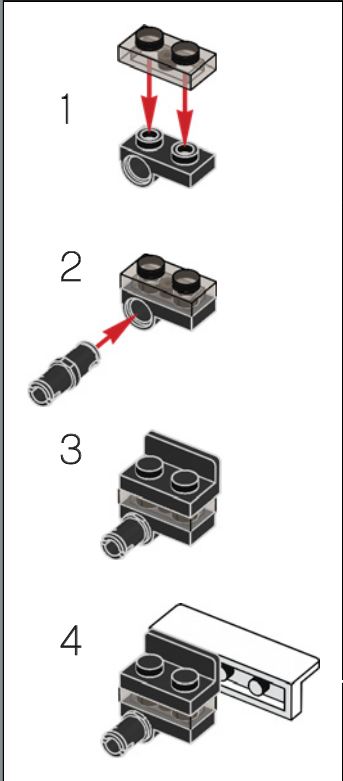

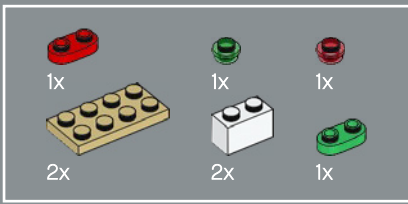

264

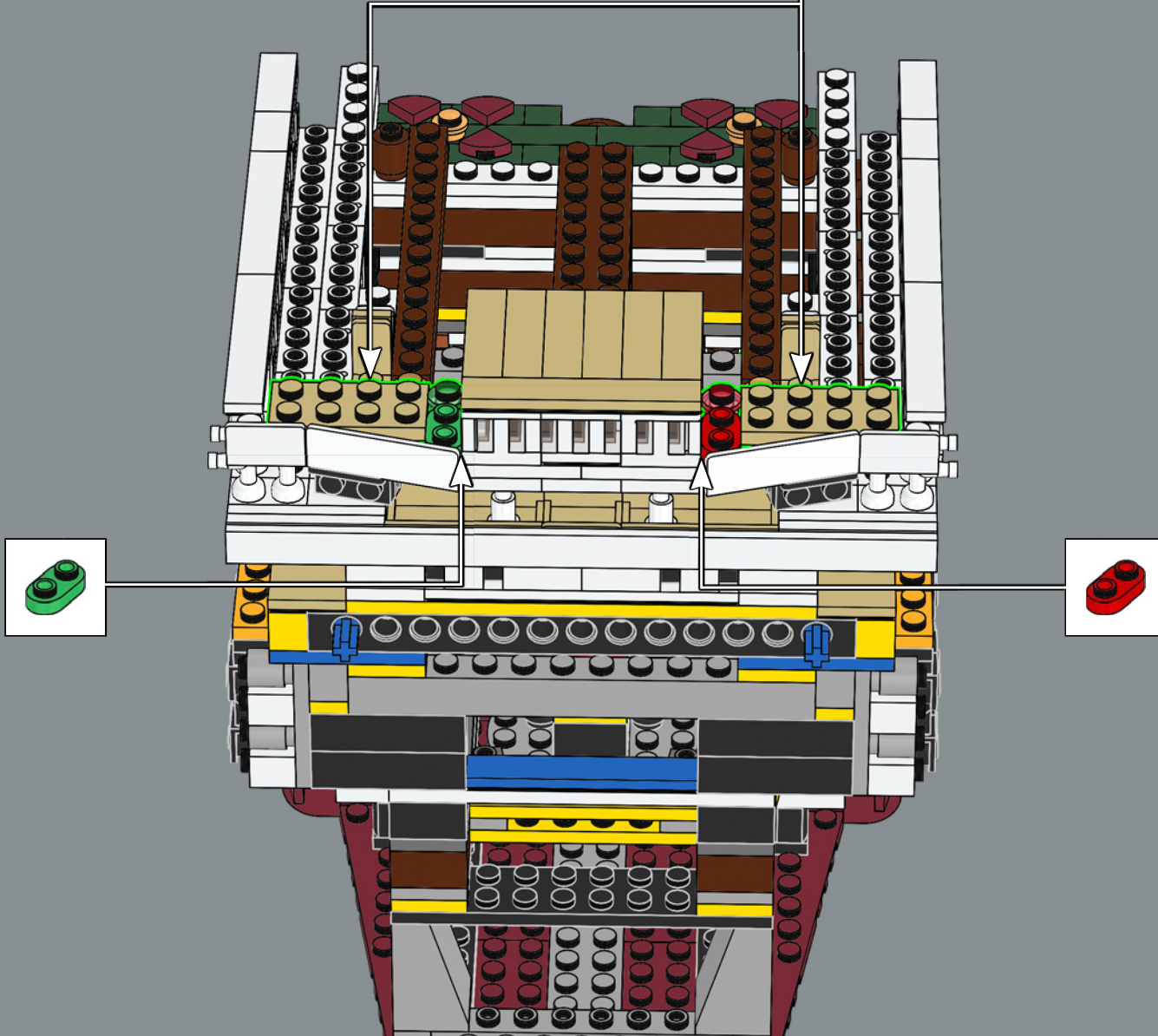
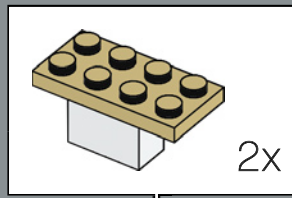

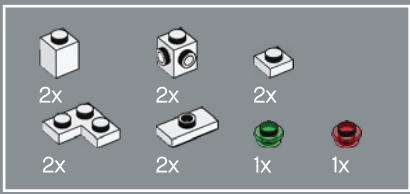

265

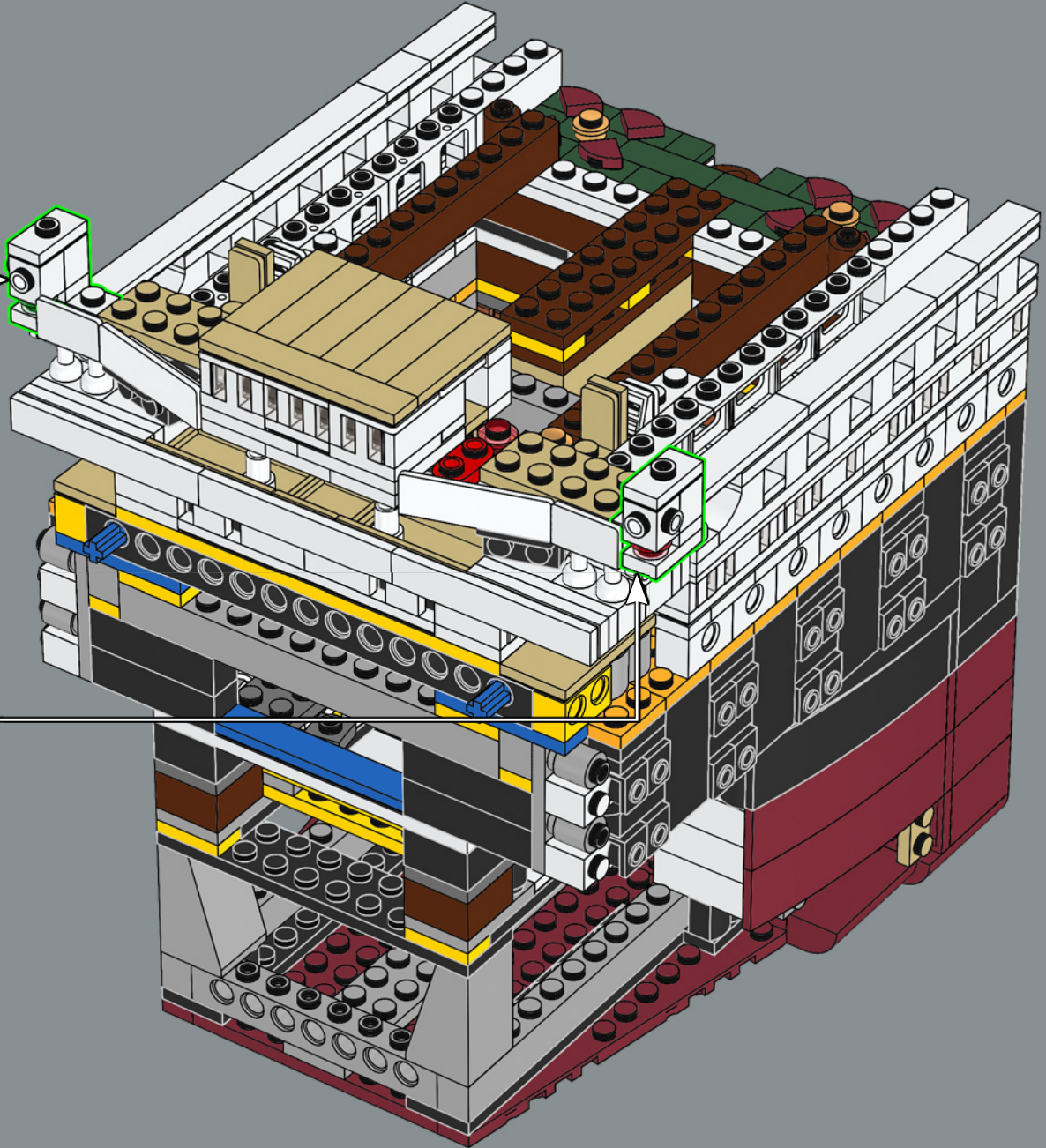
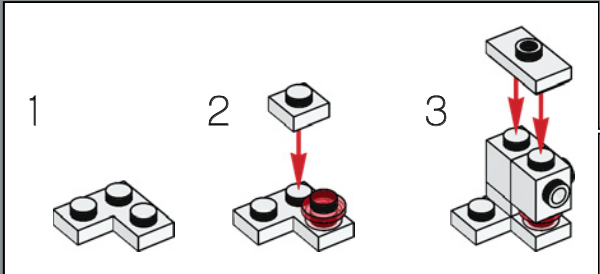
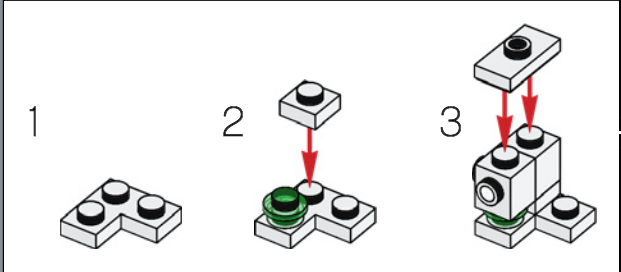

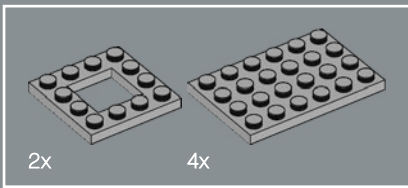

266

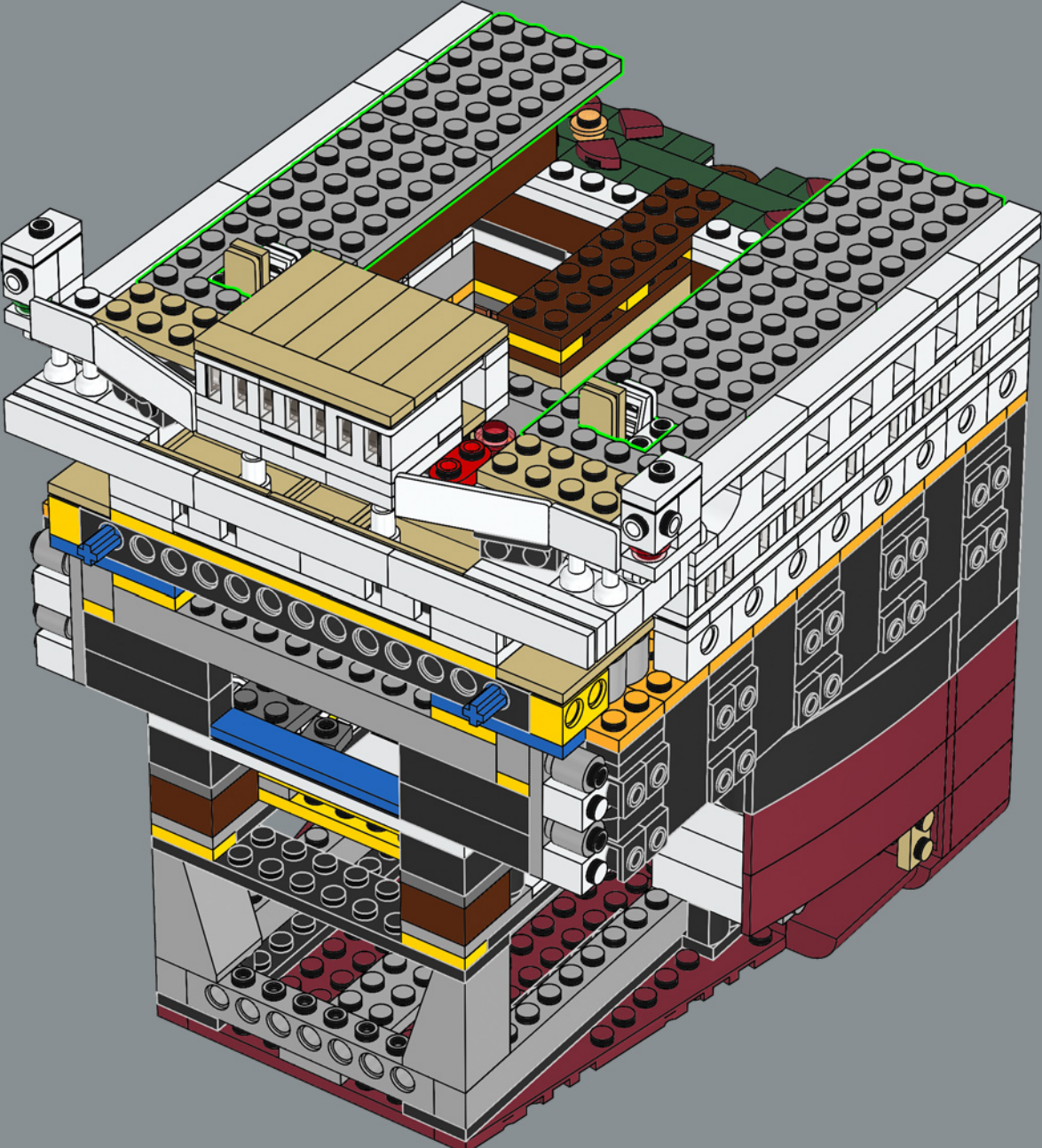

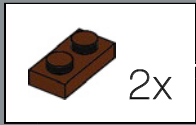
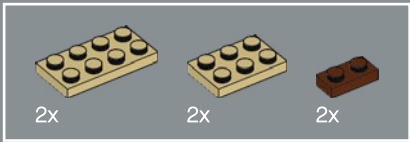

267

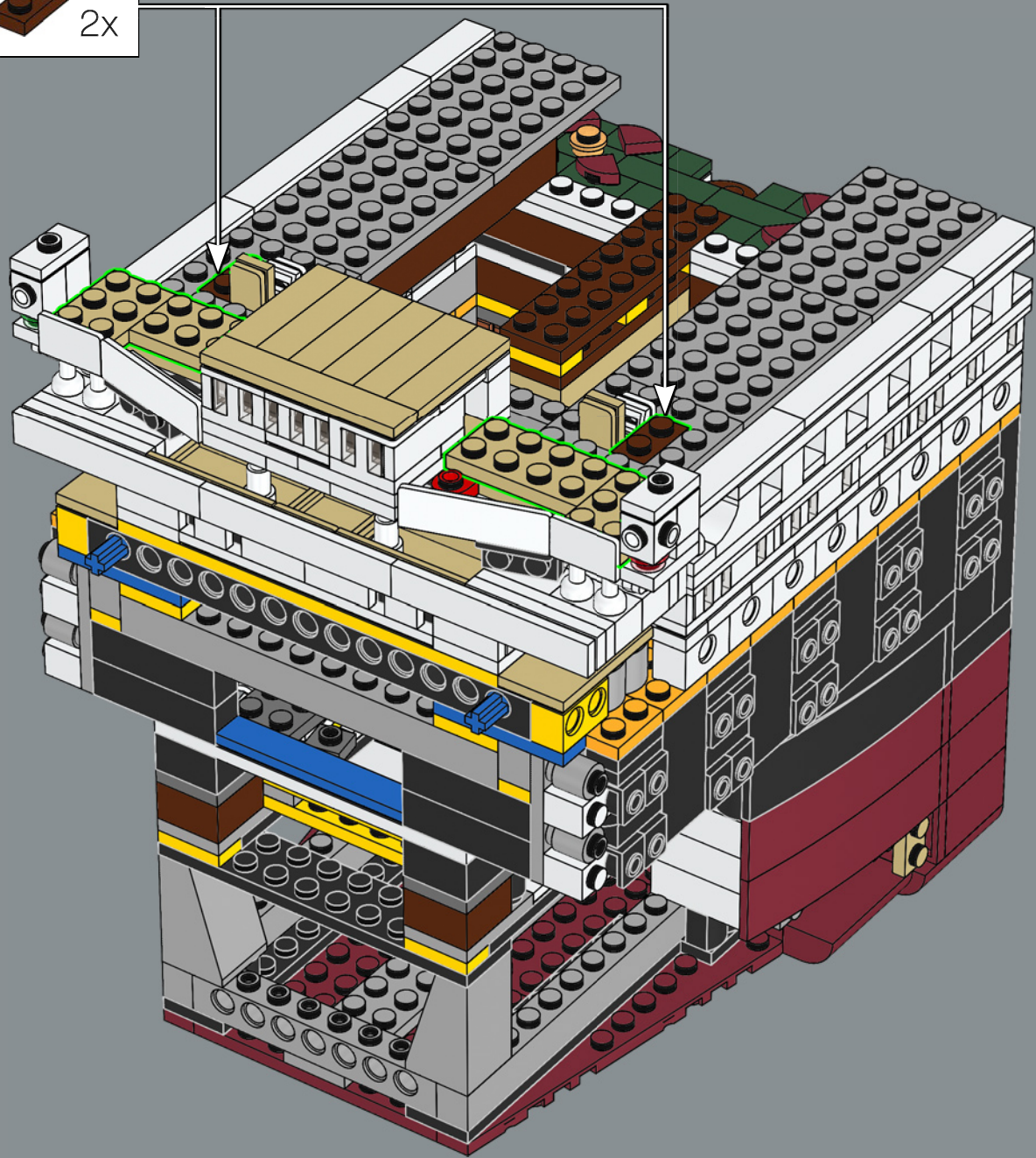

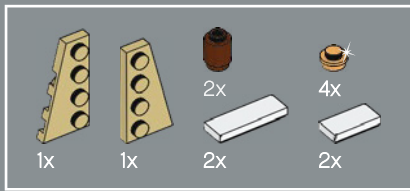

268

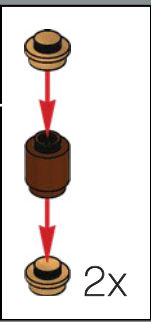
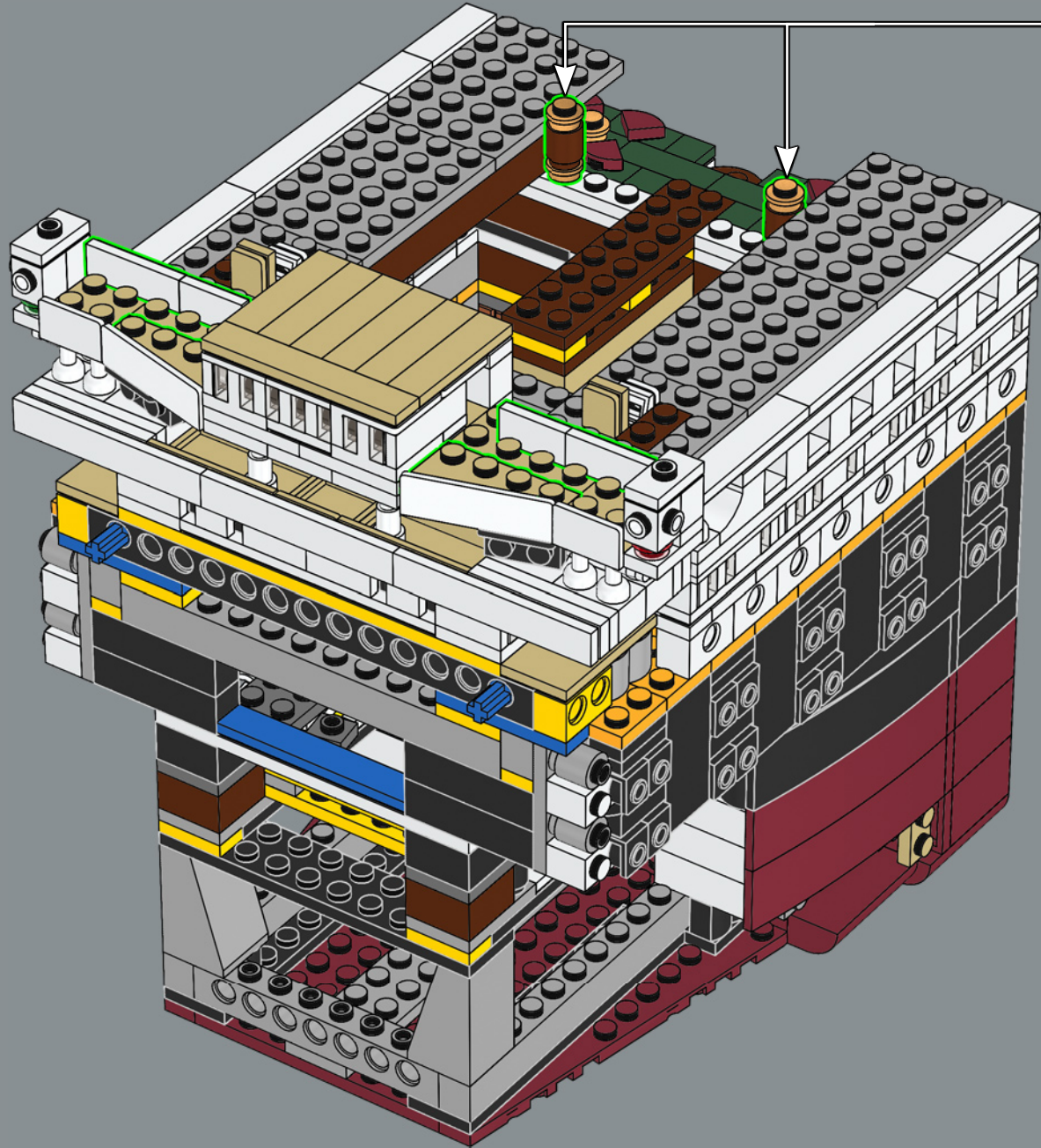
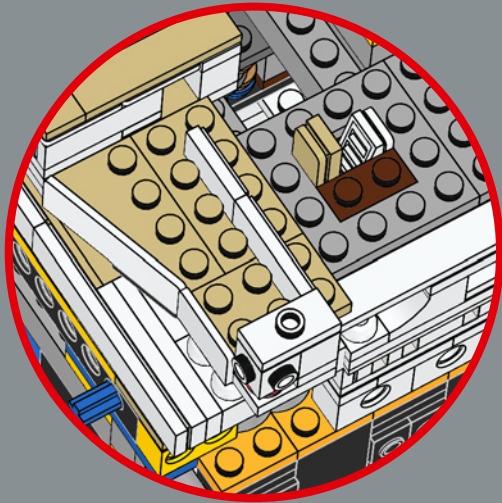
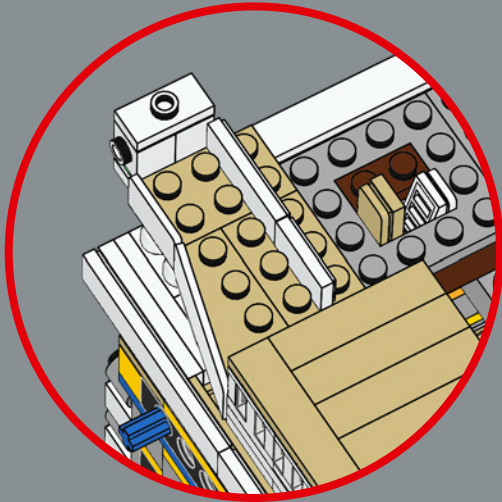

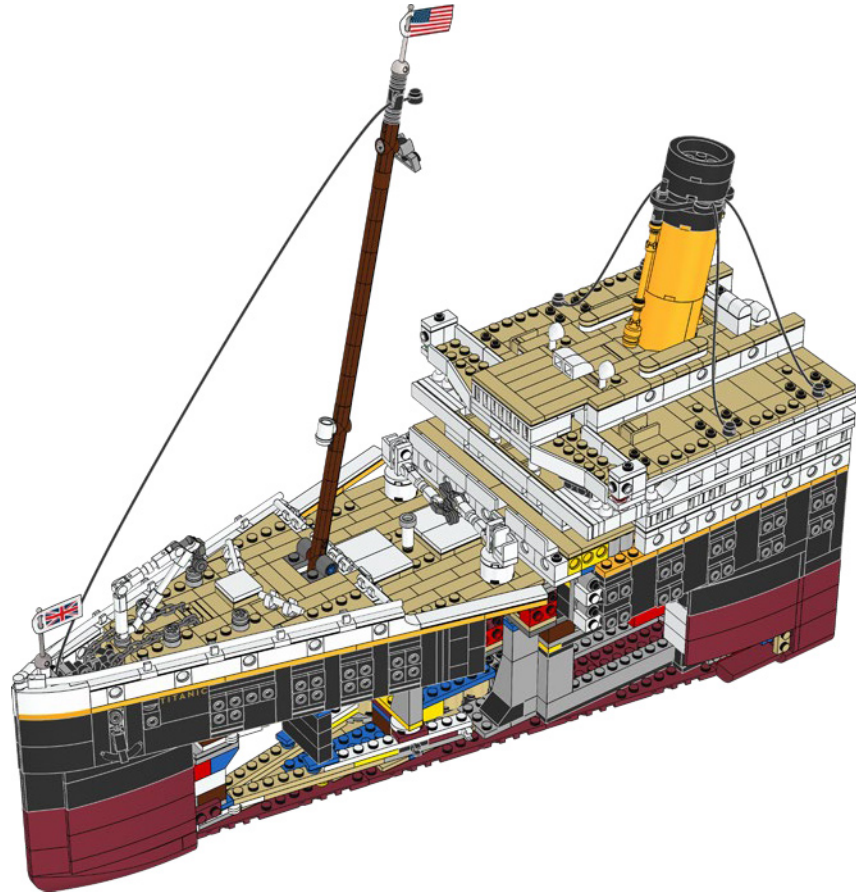
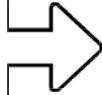

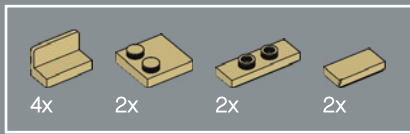

269

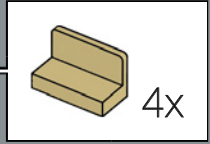
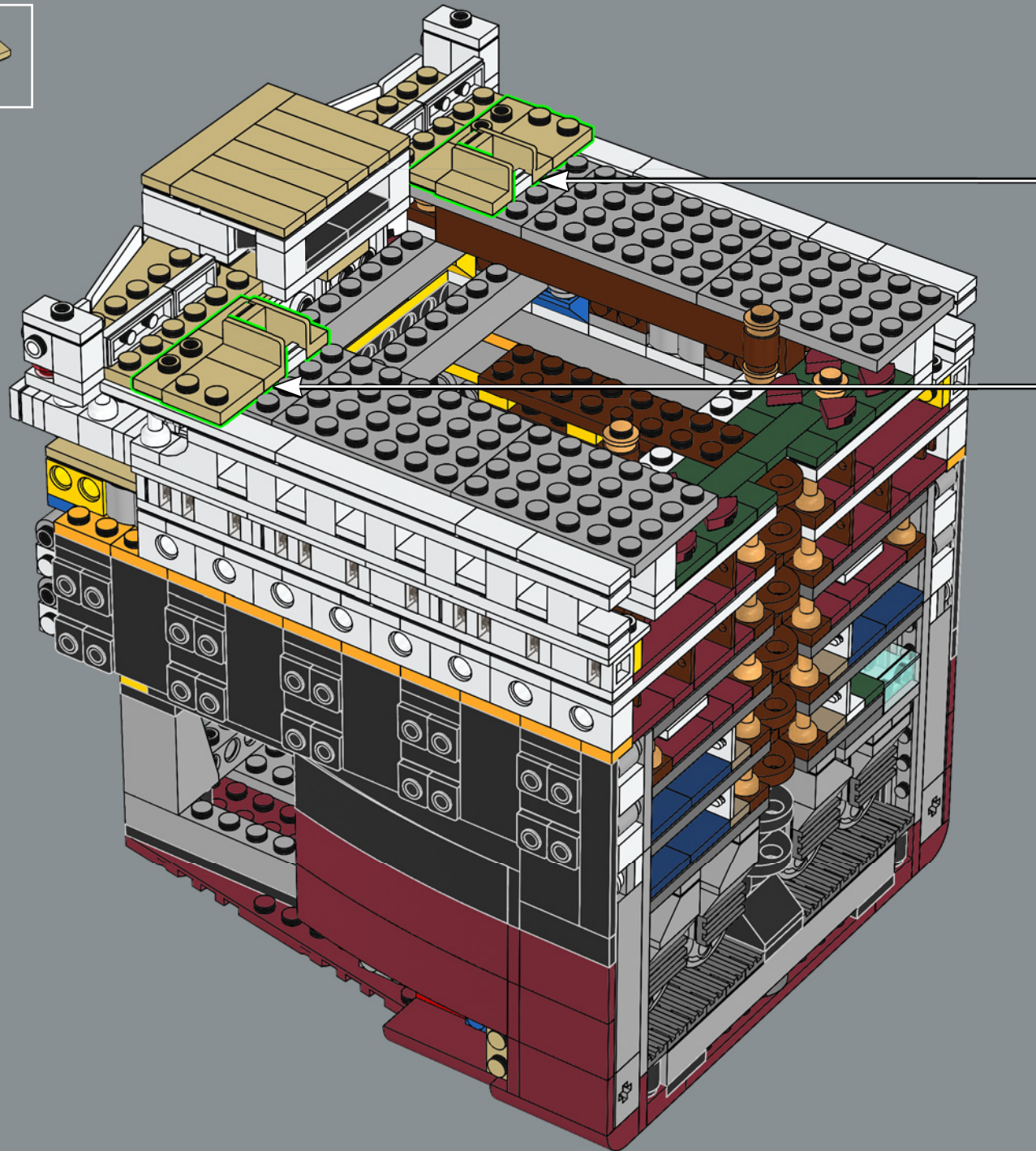

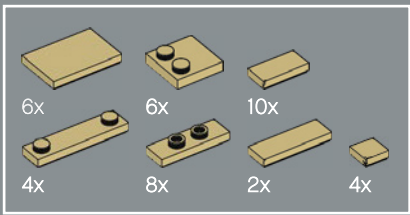

270

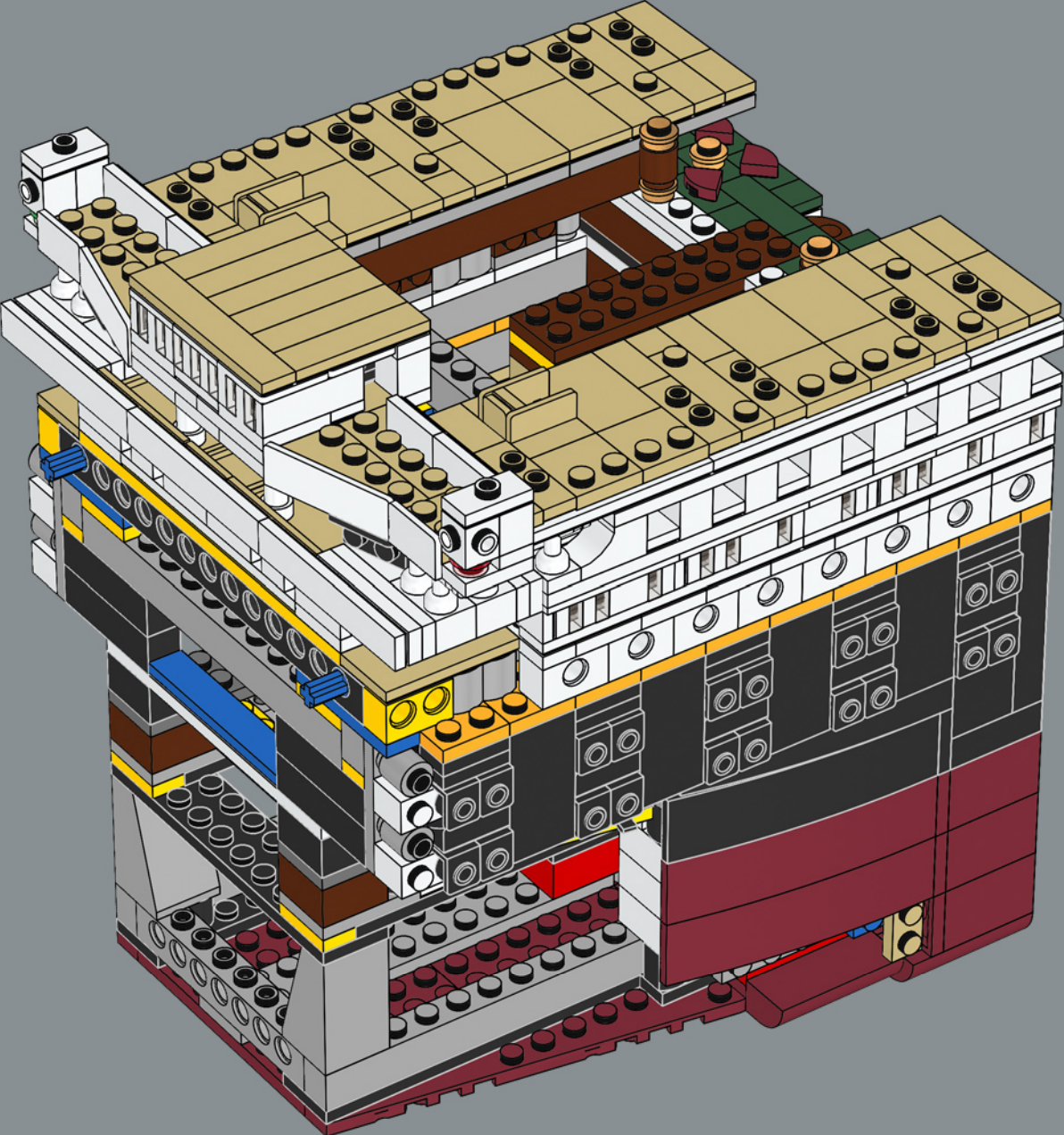

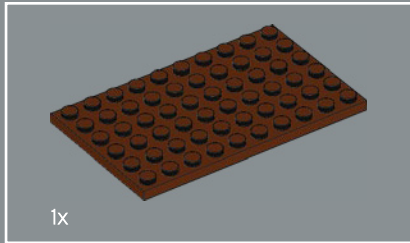
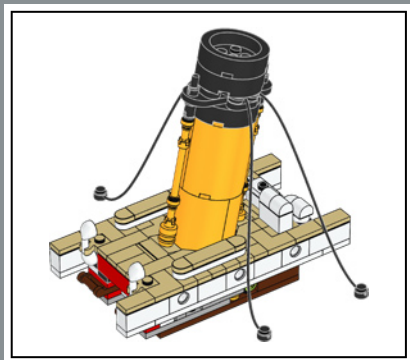

271

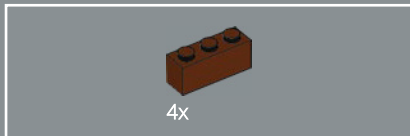

272

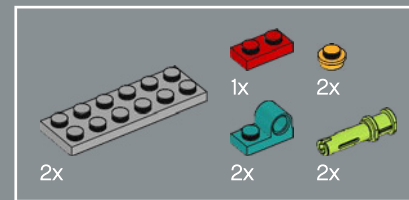
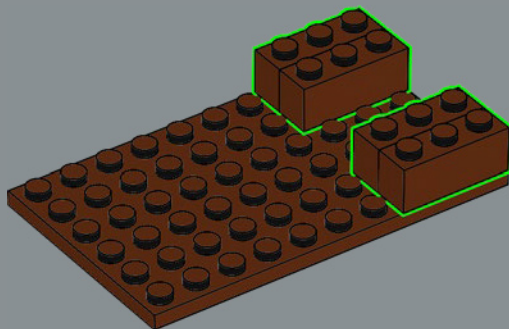
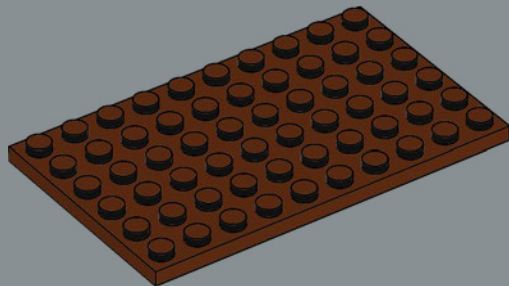

273

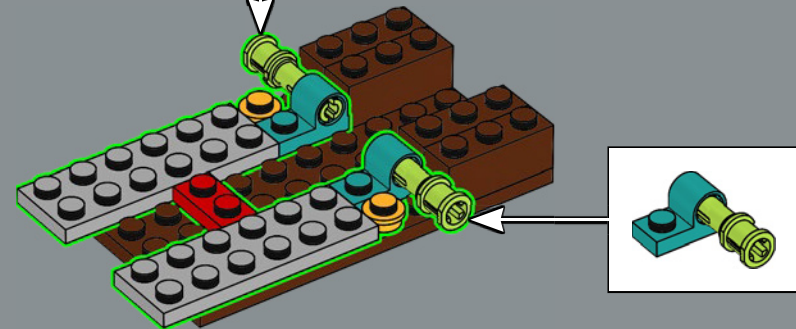
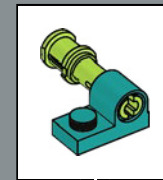

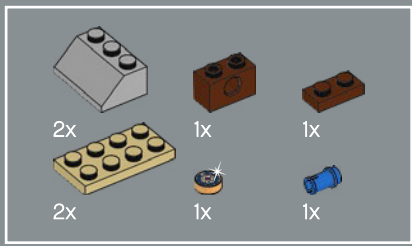

274

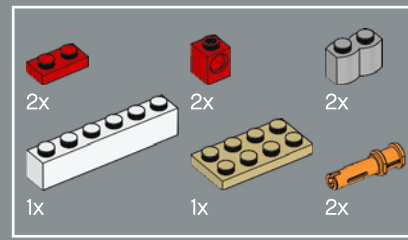
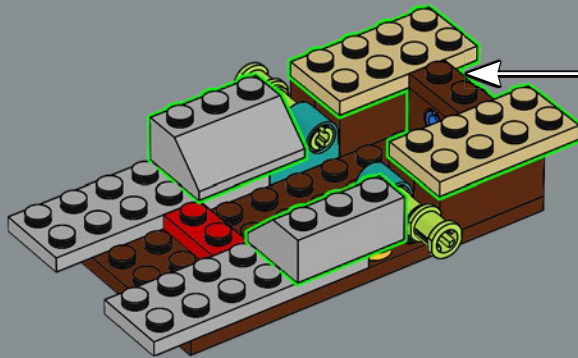
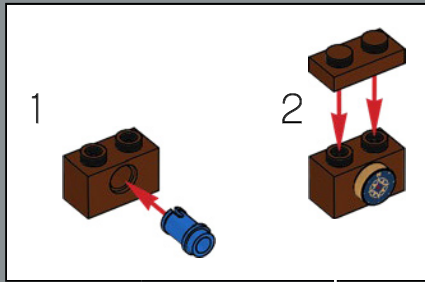

275

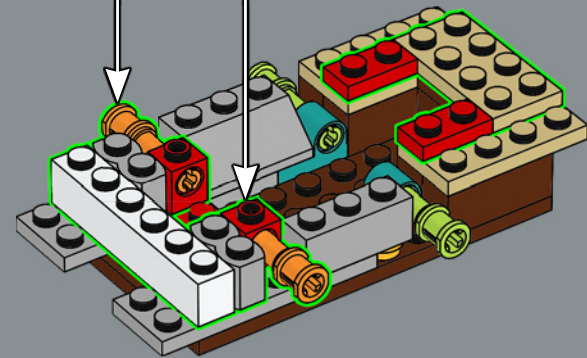
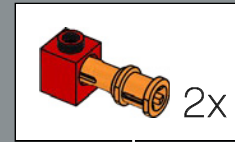

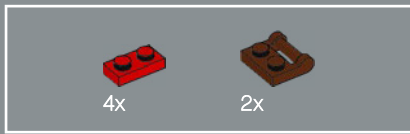

276

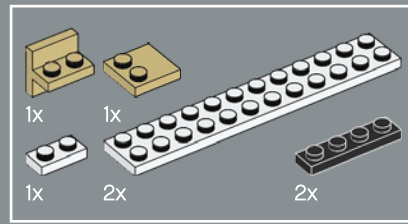
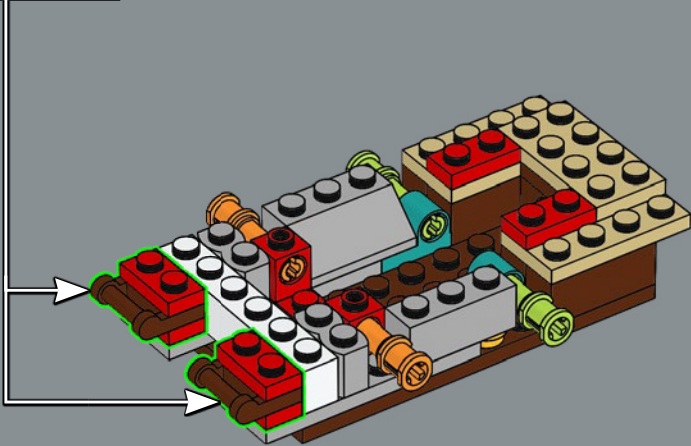
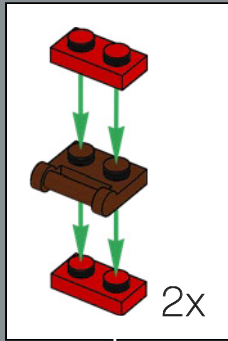

277

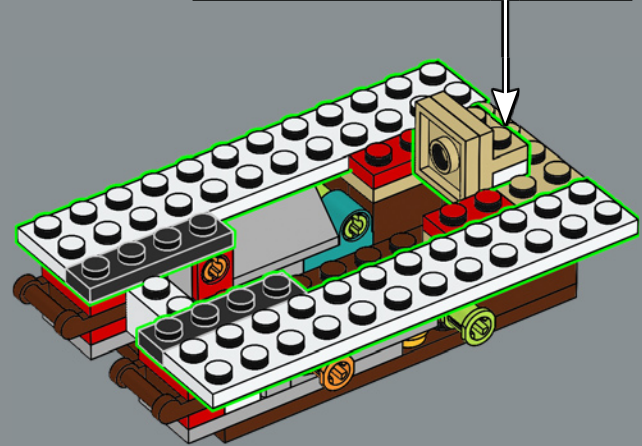
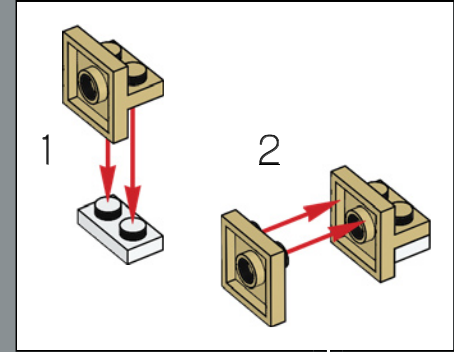

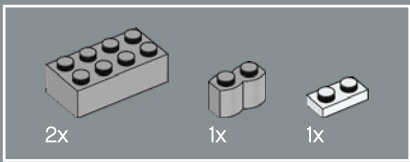

278

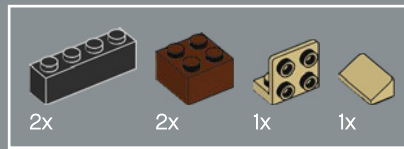
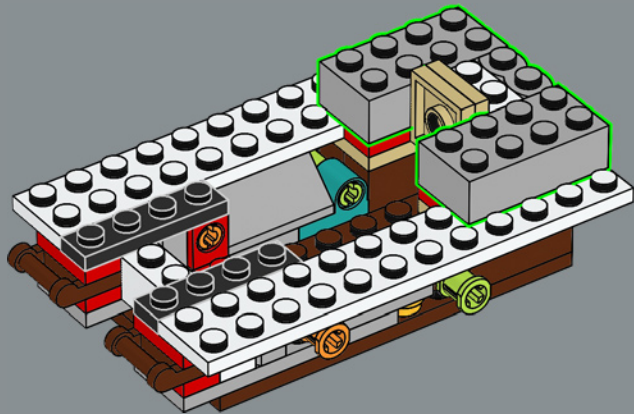

279

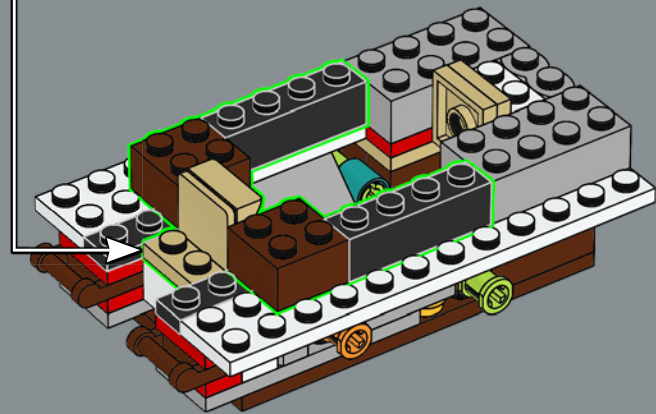
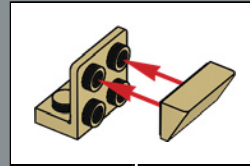

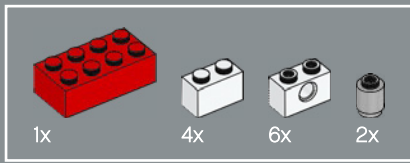

280

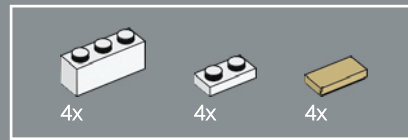
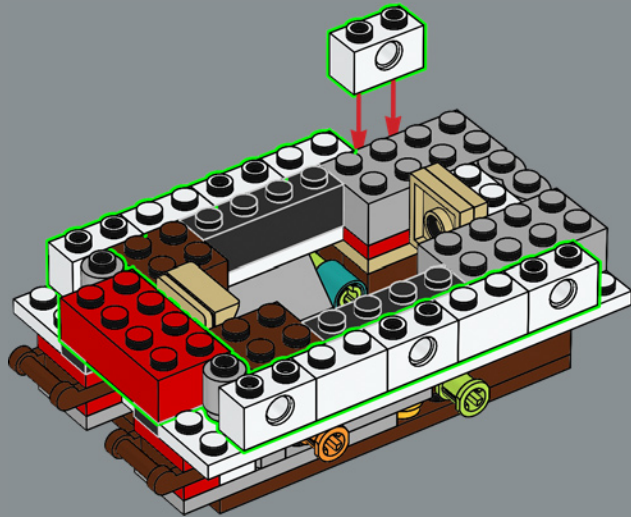

281

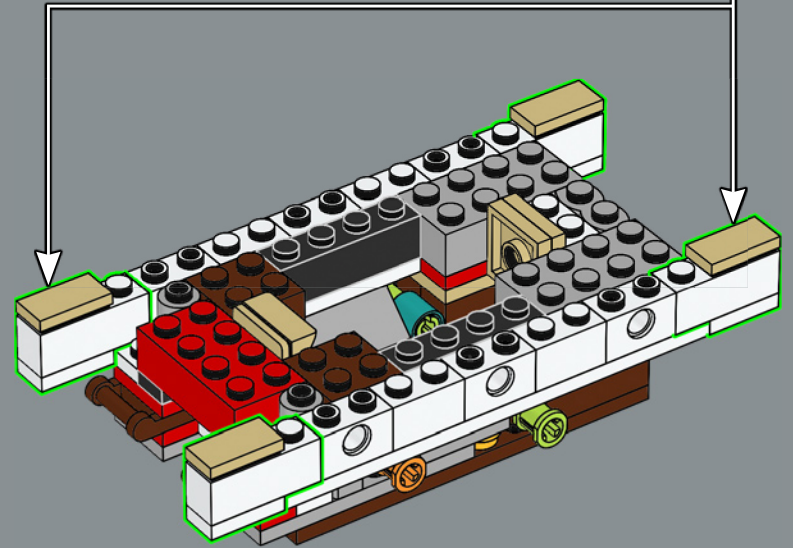
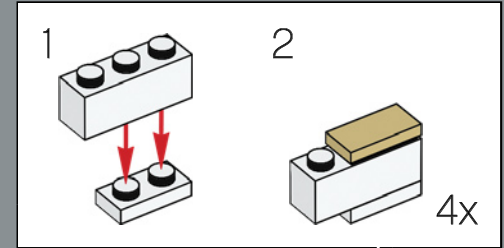

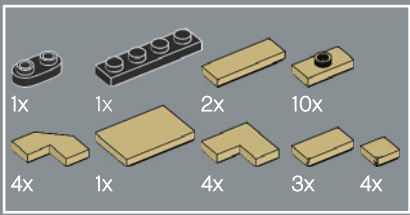

282

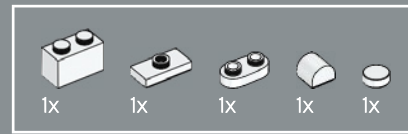
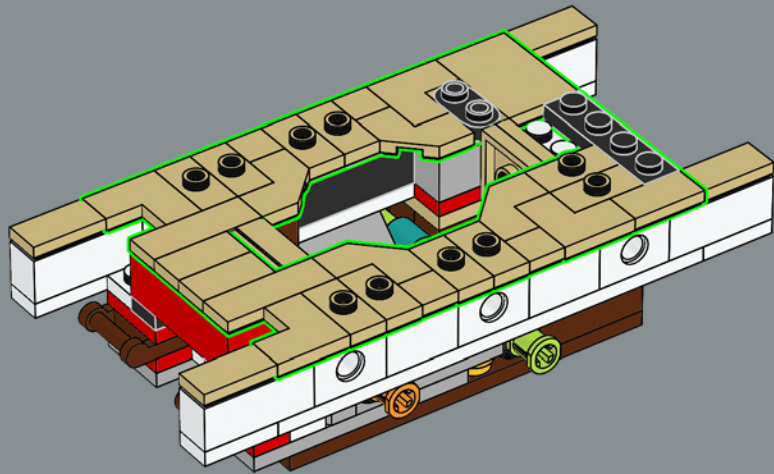

283

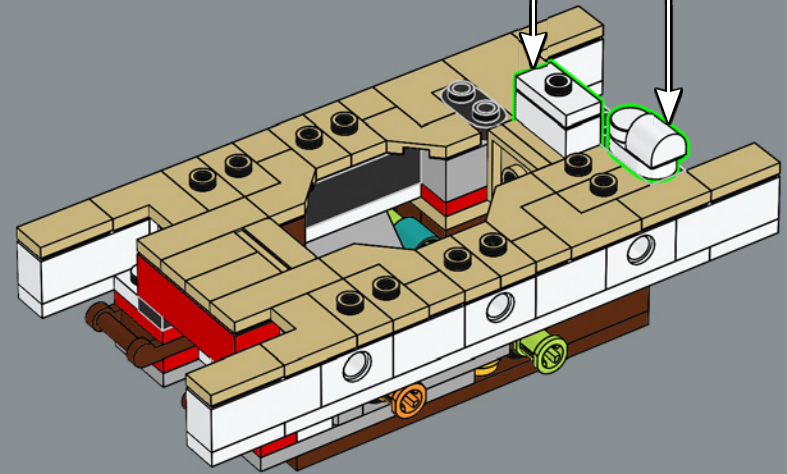
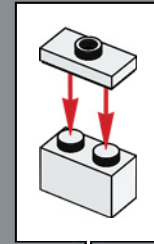
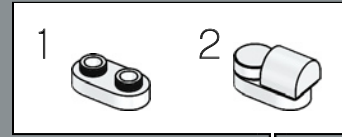

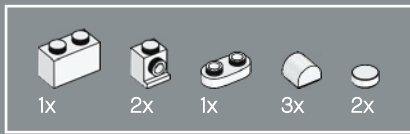

284

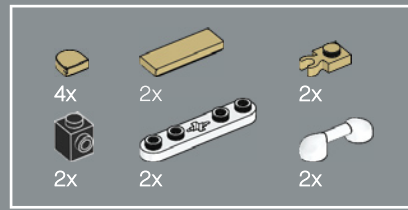
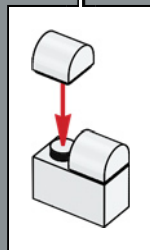
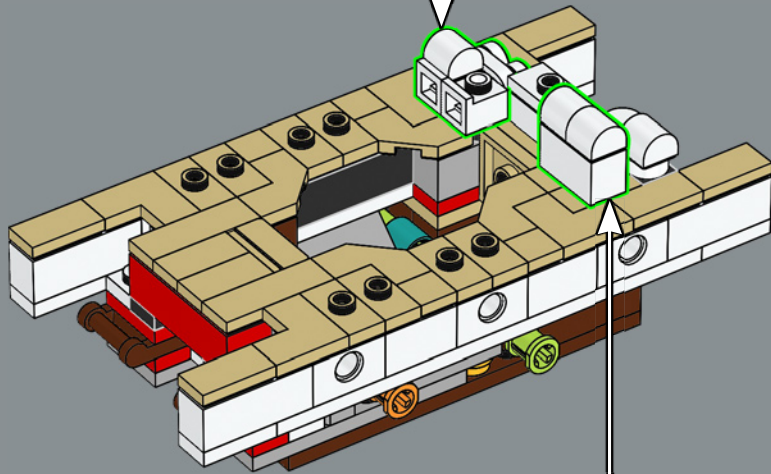
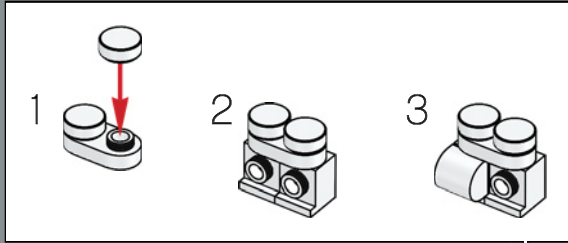

285

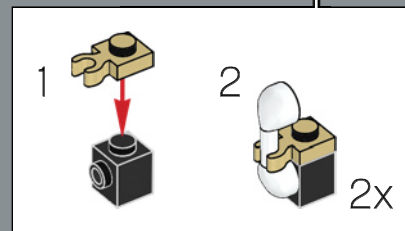
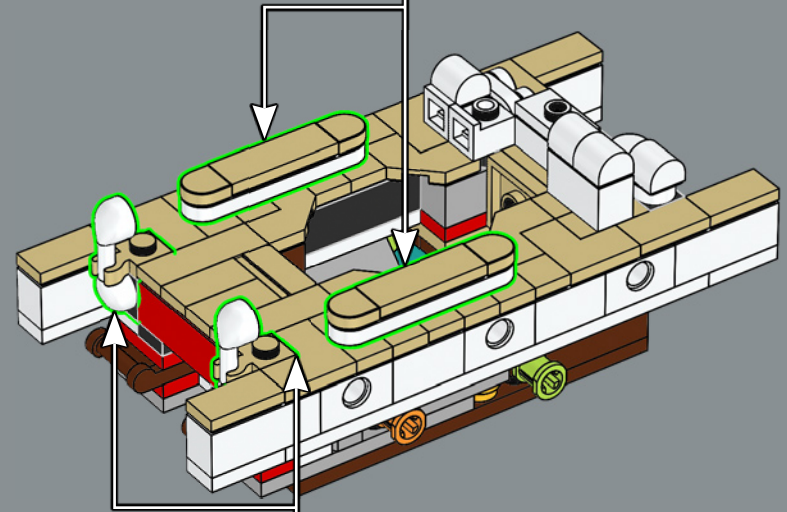
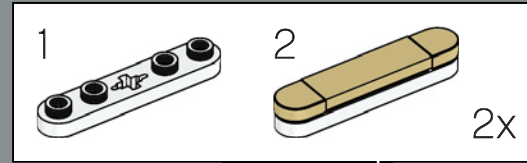

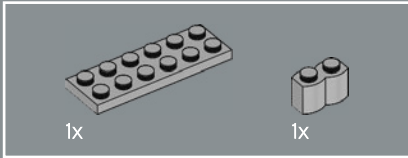
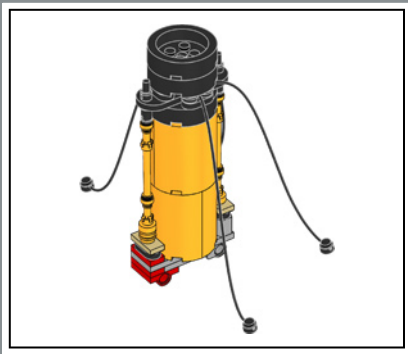

286

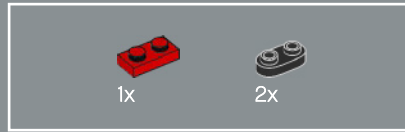
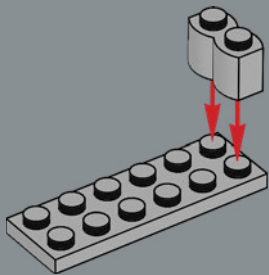

287

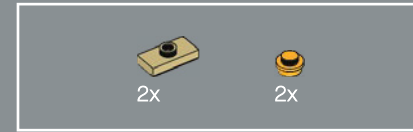
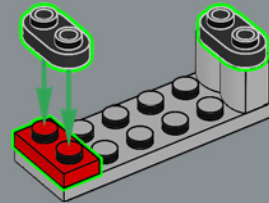

288

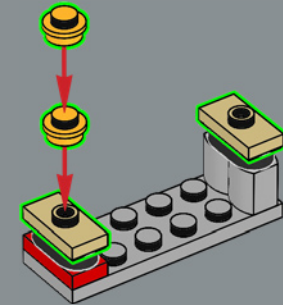

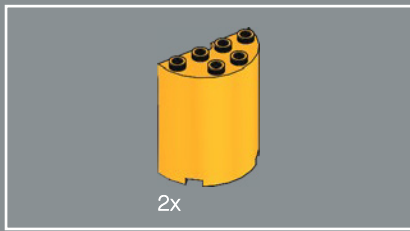

289

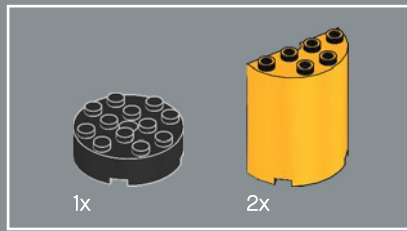
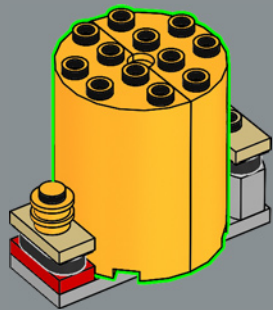

290

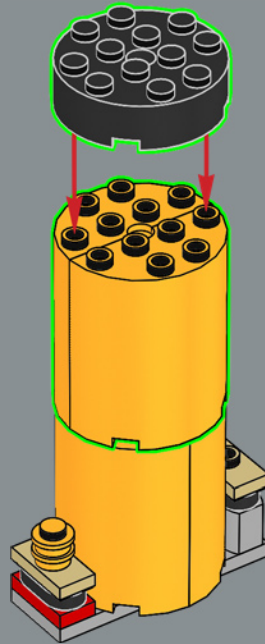

291

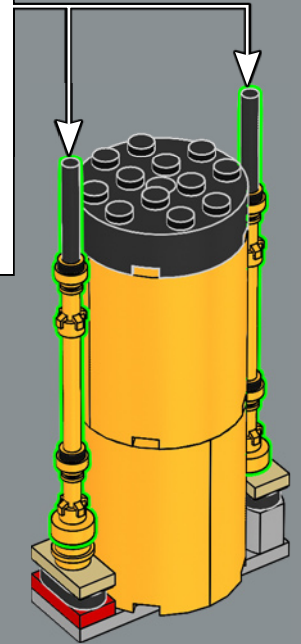
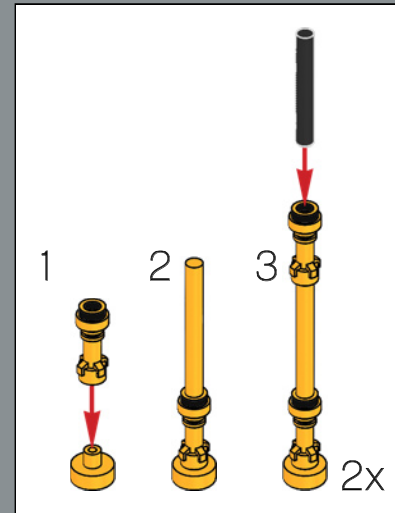

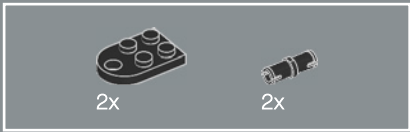

292

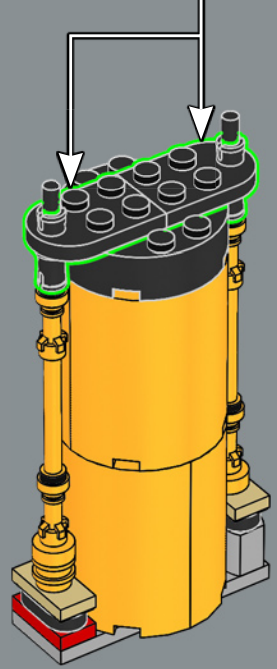
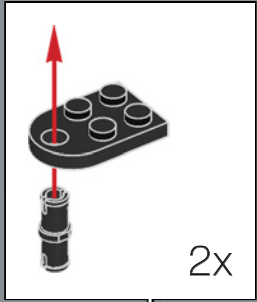

293

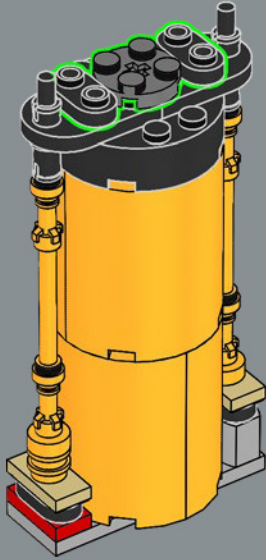

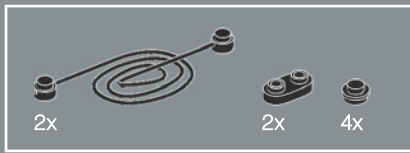

294

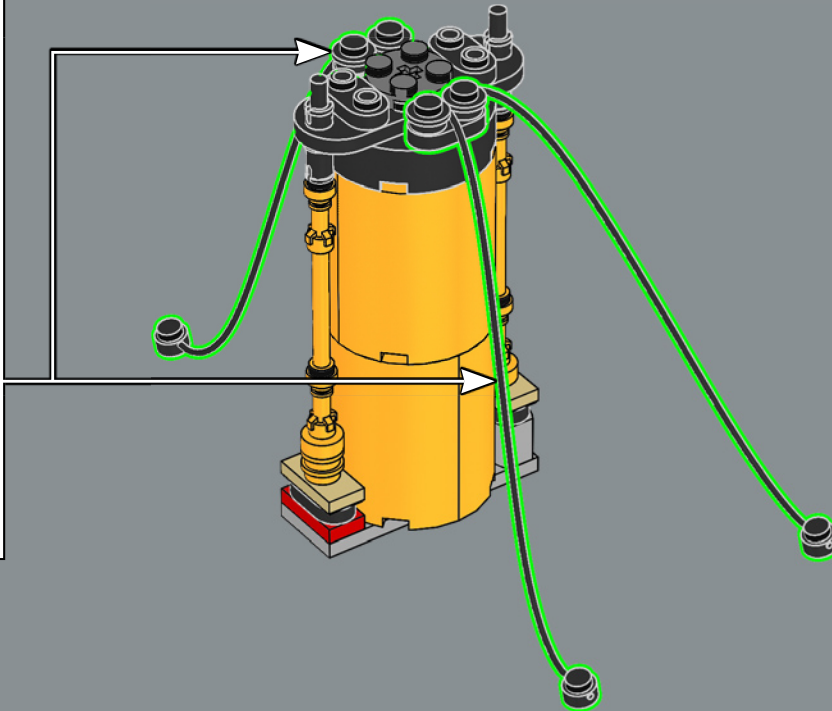
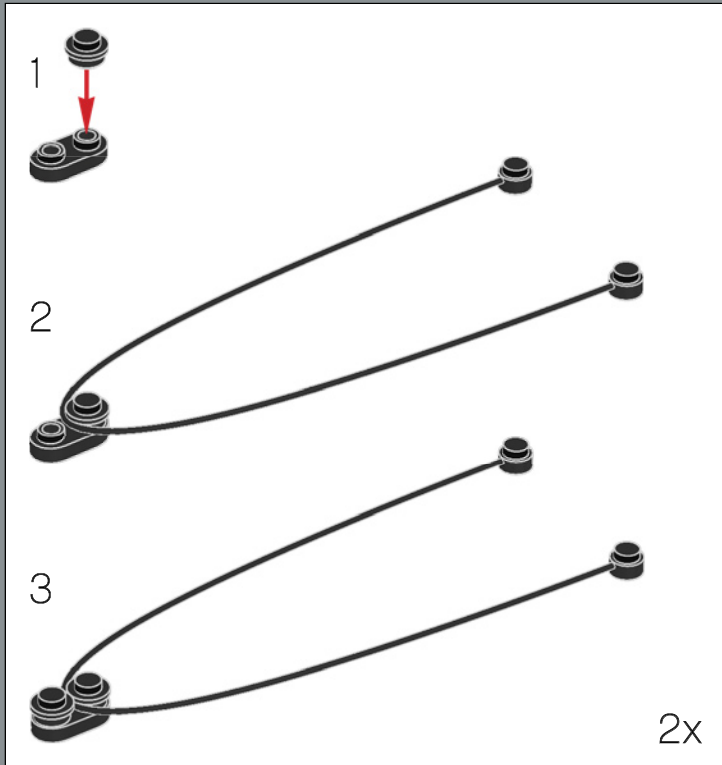

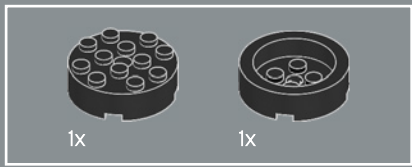

295

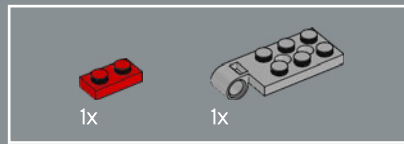
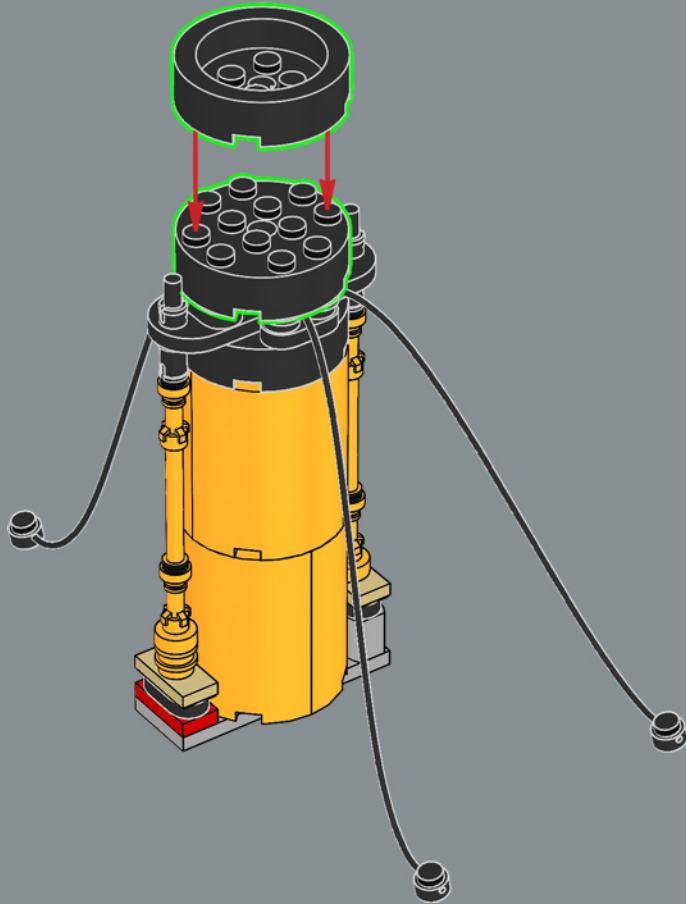

296

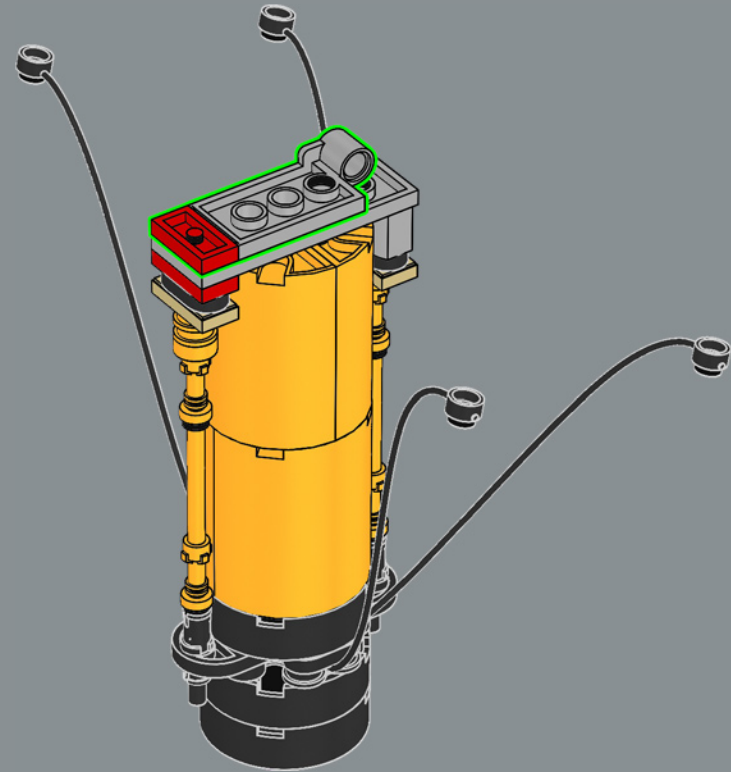

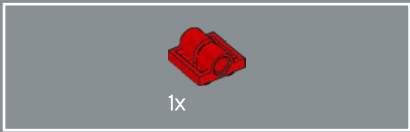

297

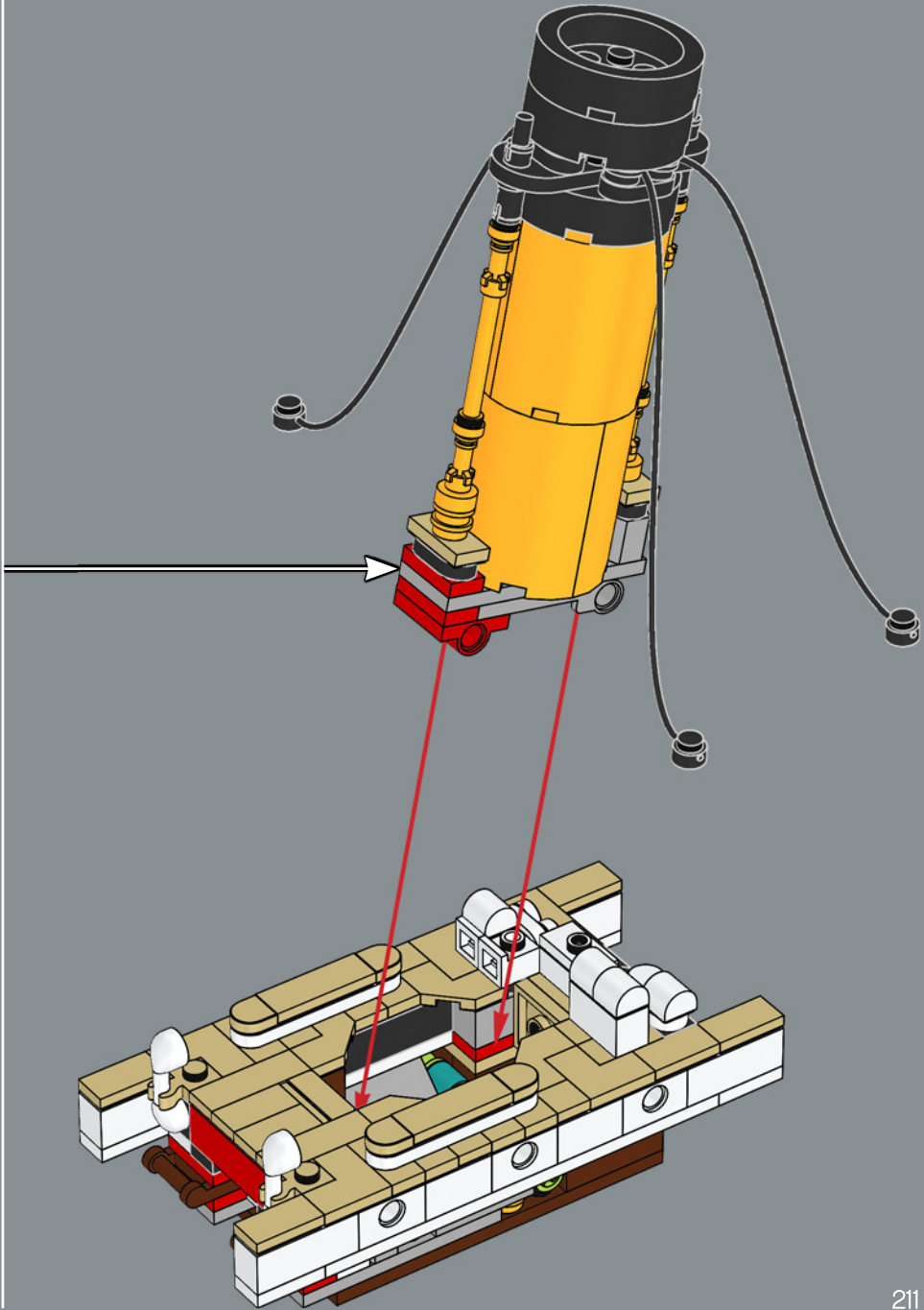
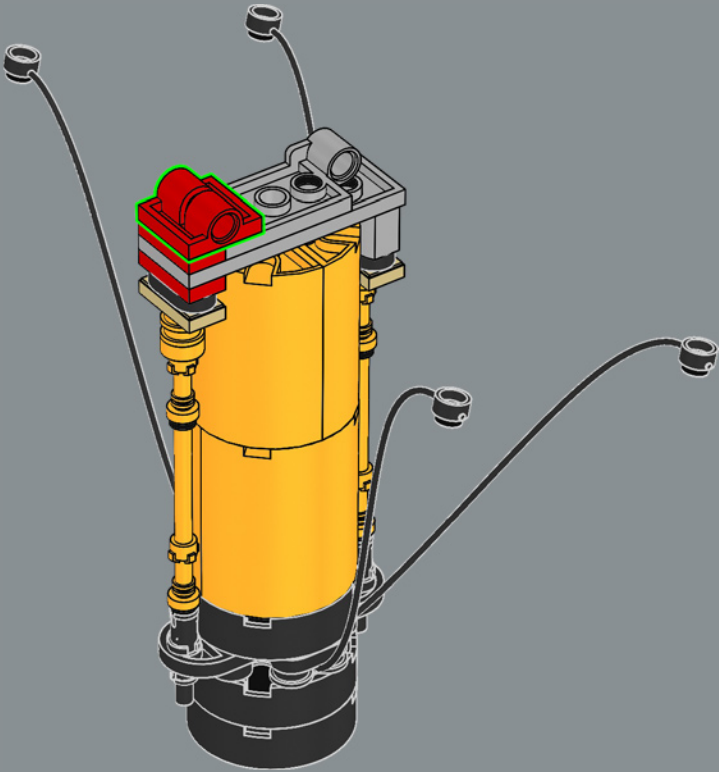

La sala de comunicaciones del barco contenía uno de los transmisores más potentes del mundo, con un radio de alcance garantizado de 563 km.

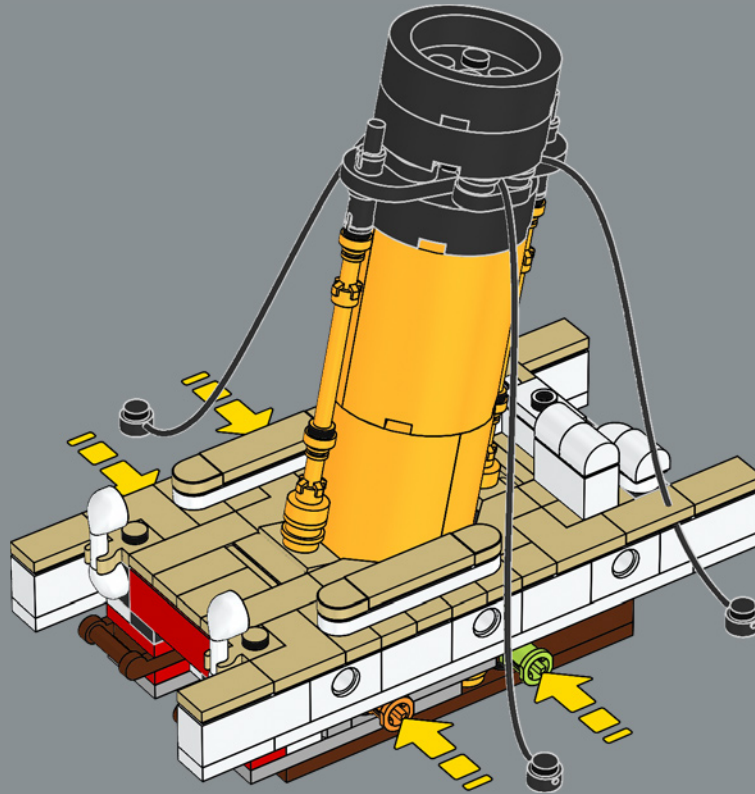

299

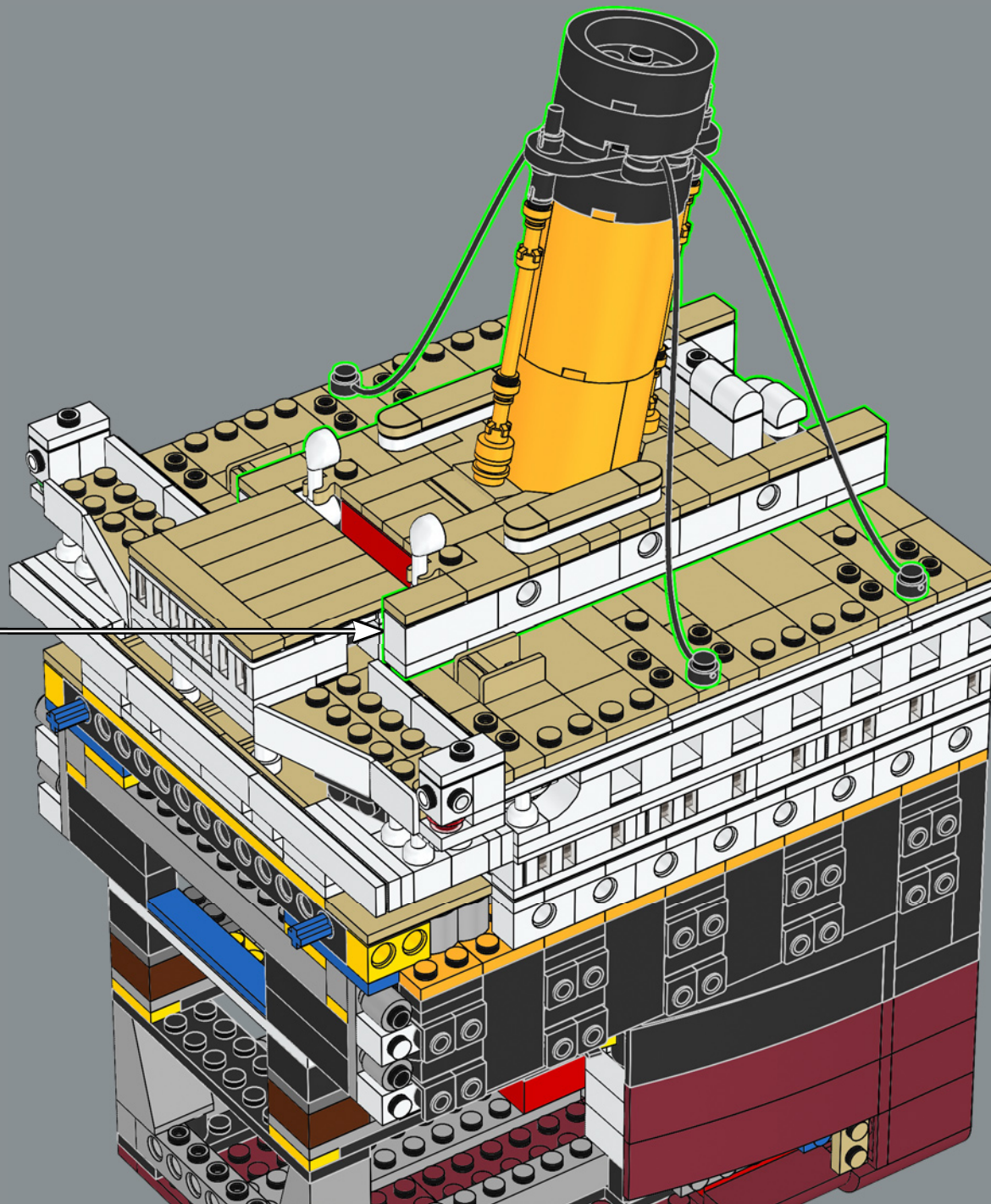

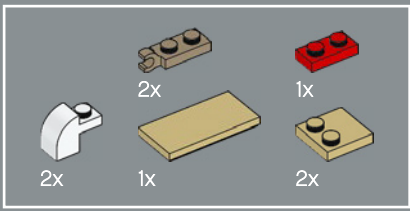

300

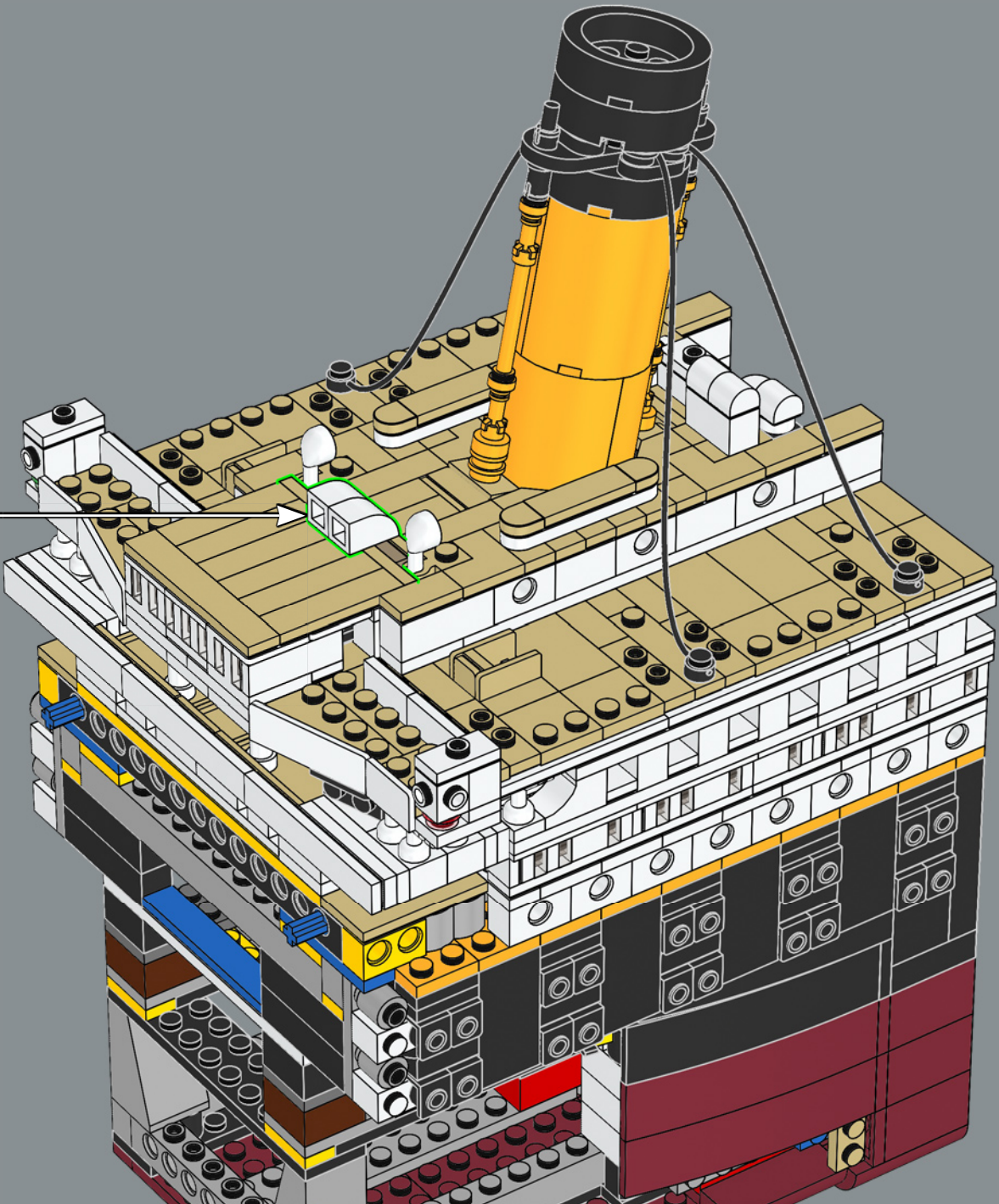
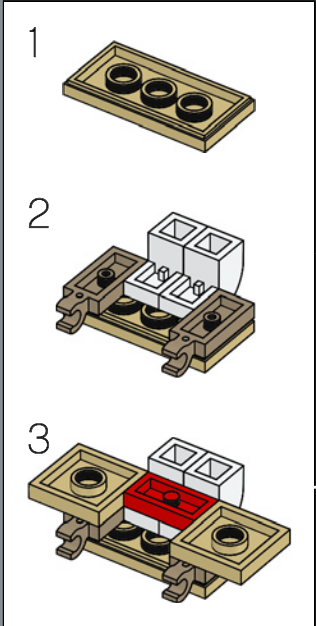

301

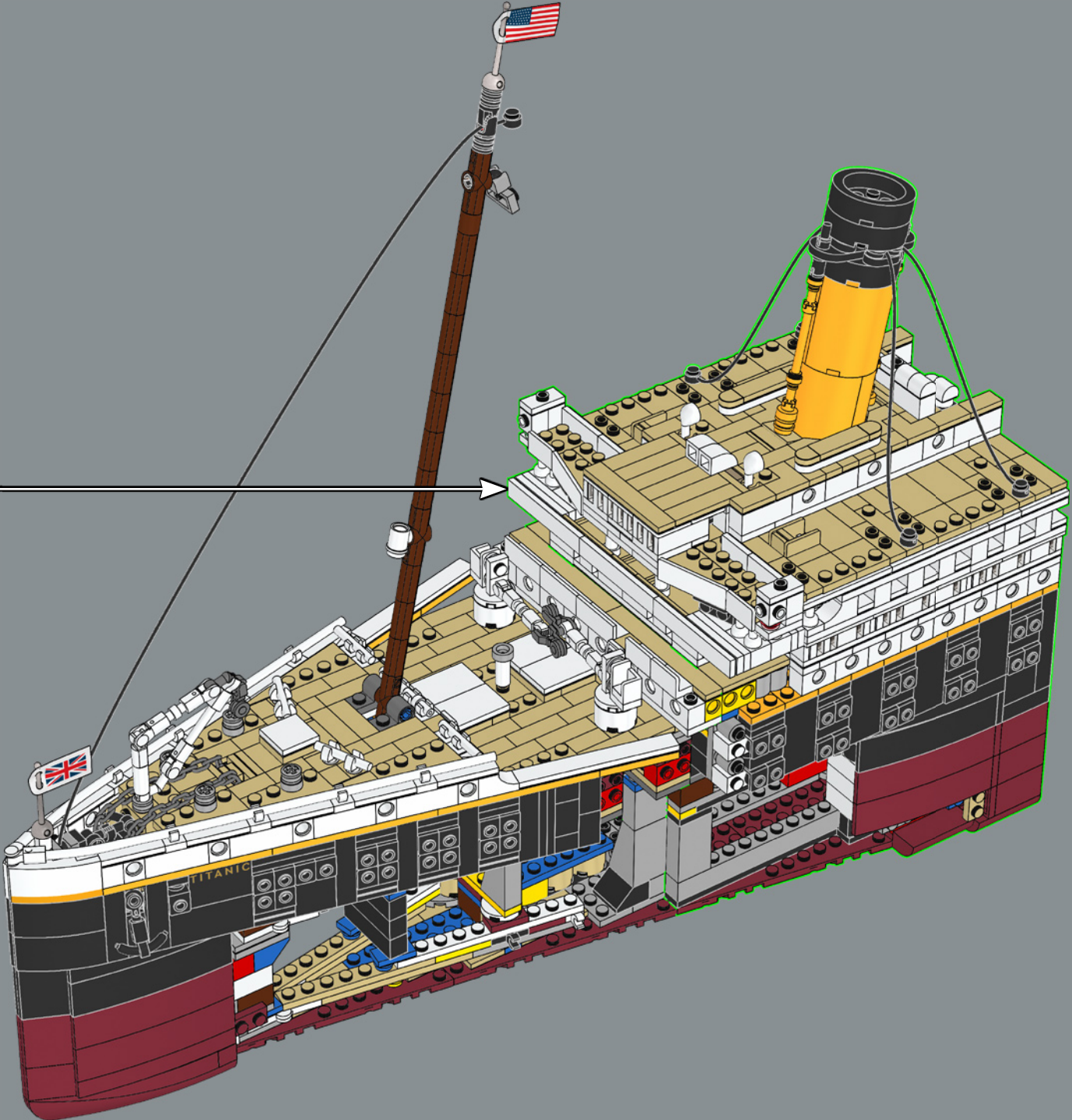

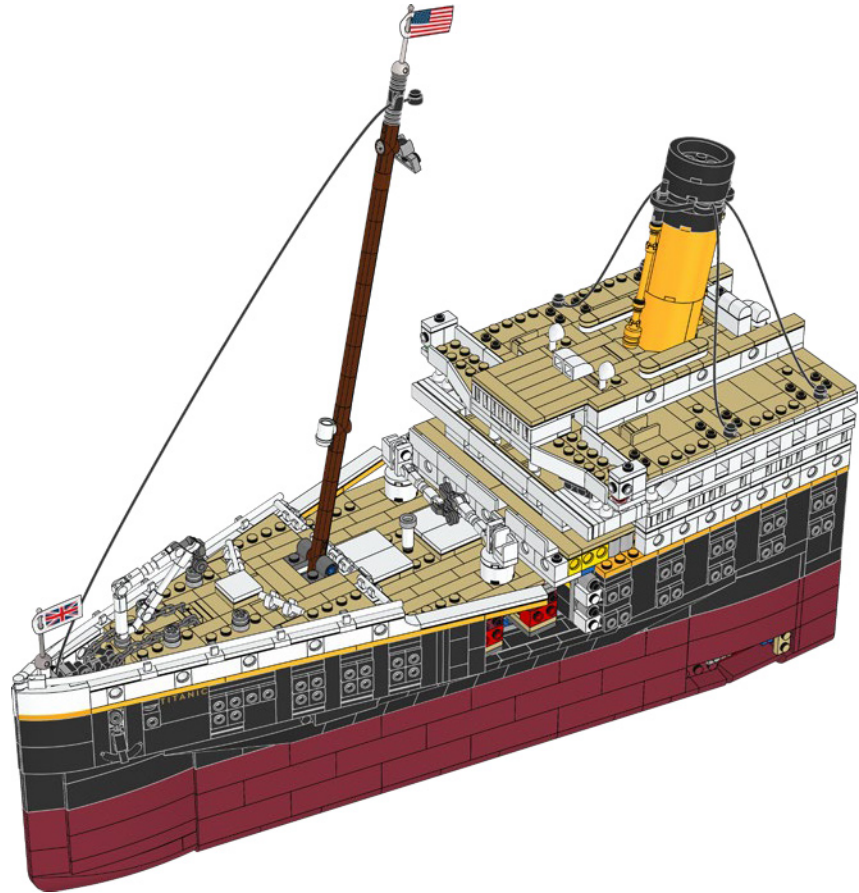
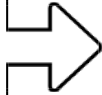

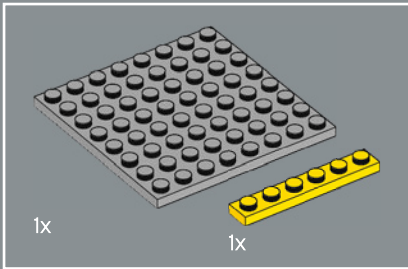
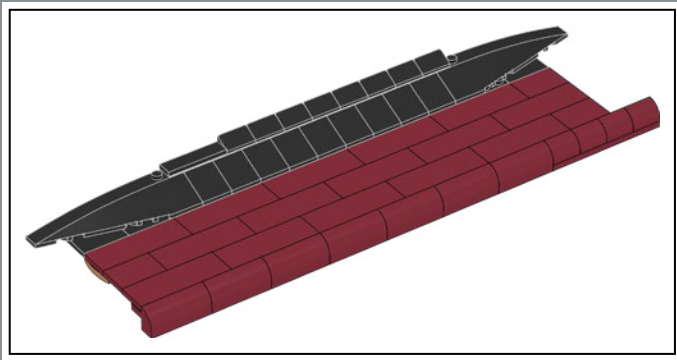

302

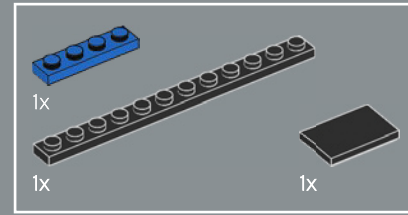
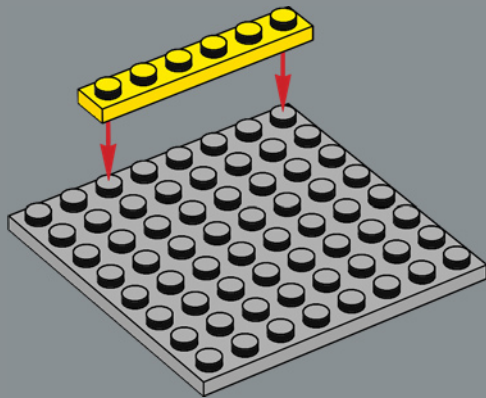

303

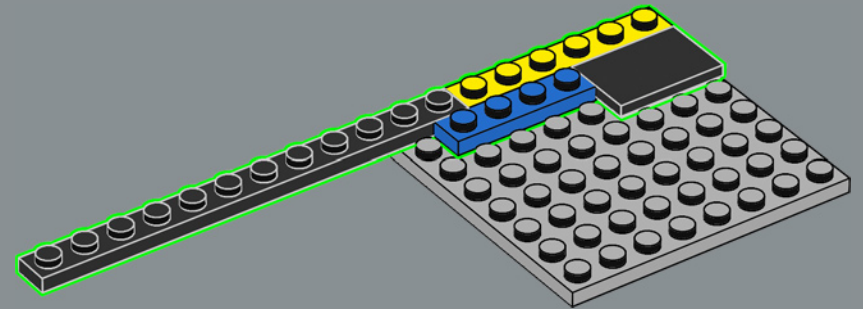

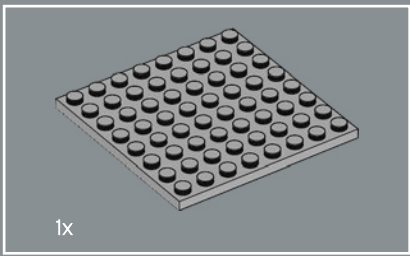

304

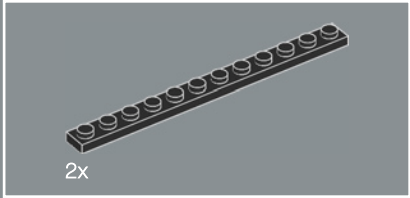
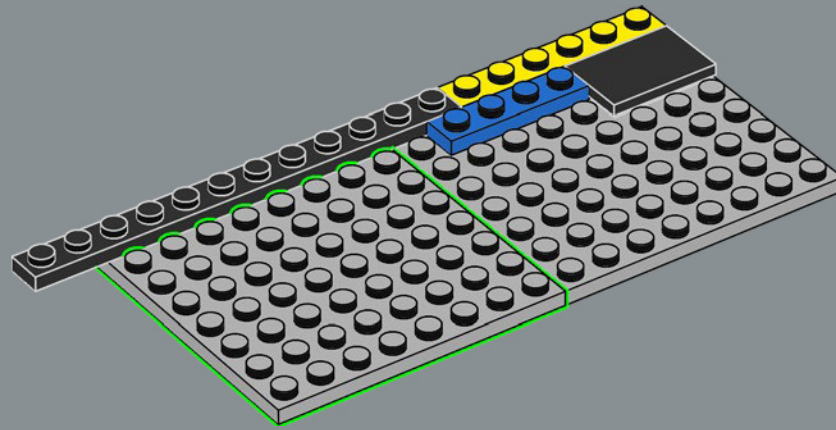

305

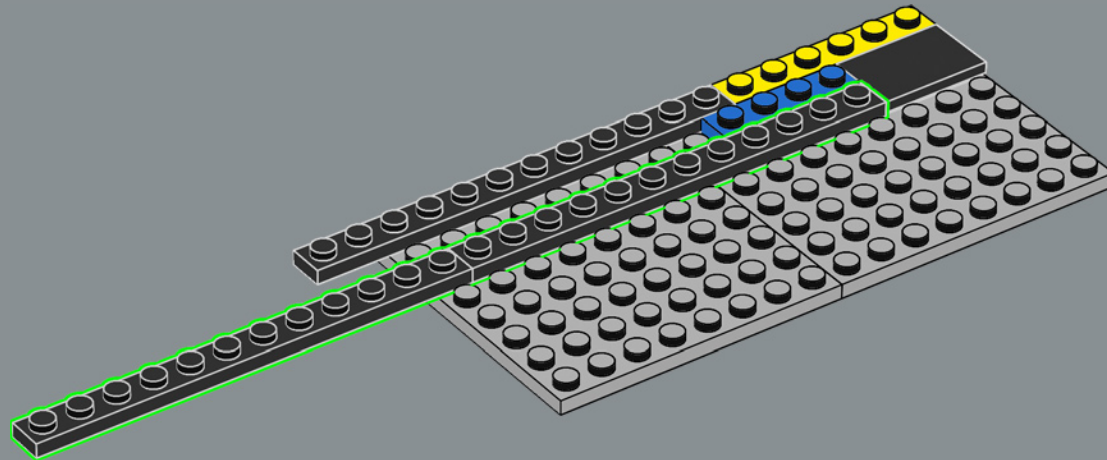

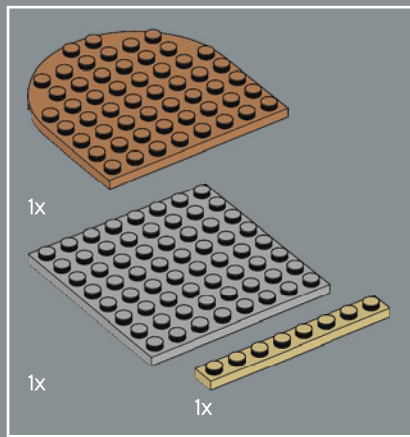

306

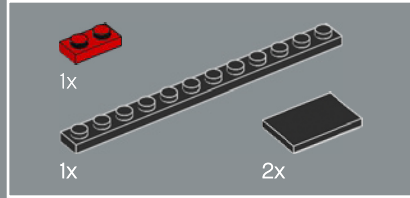
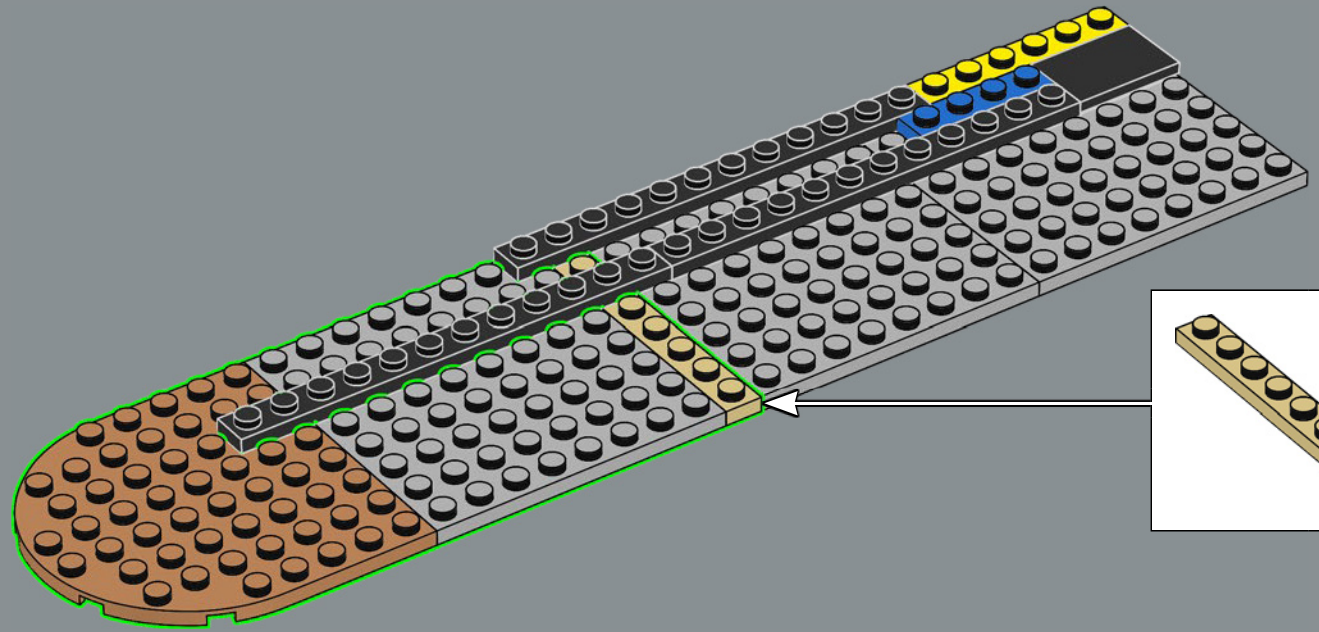

307

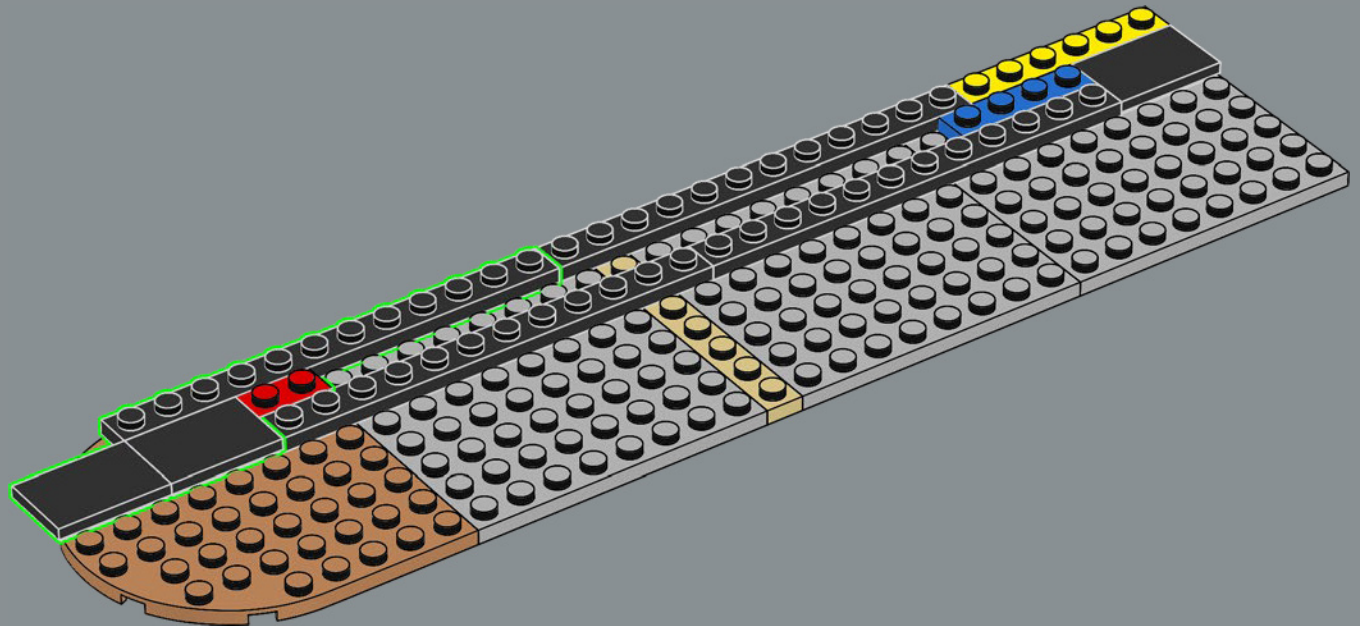

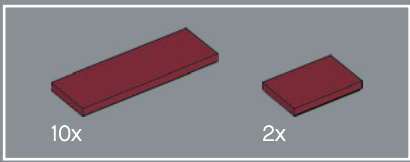

308

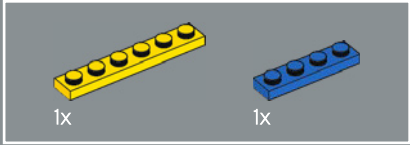
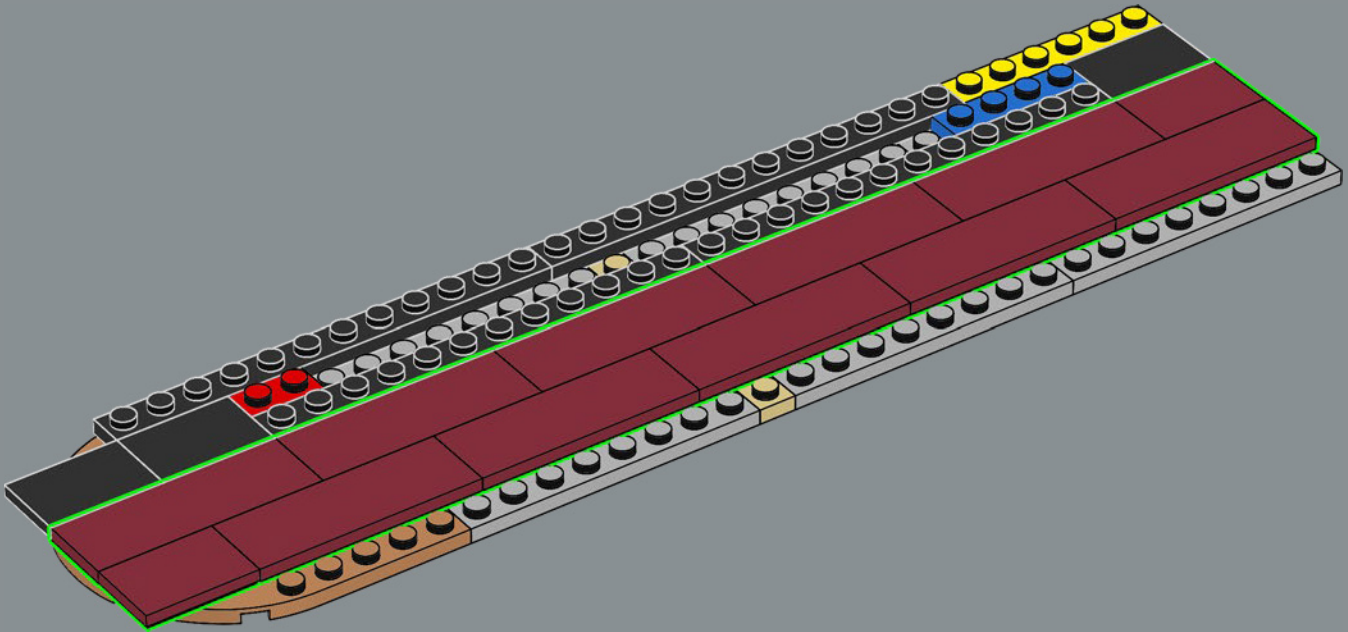

309

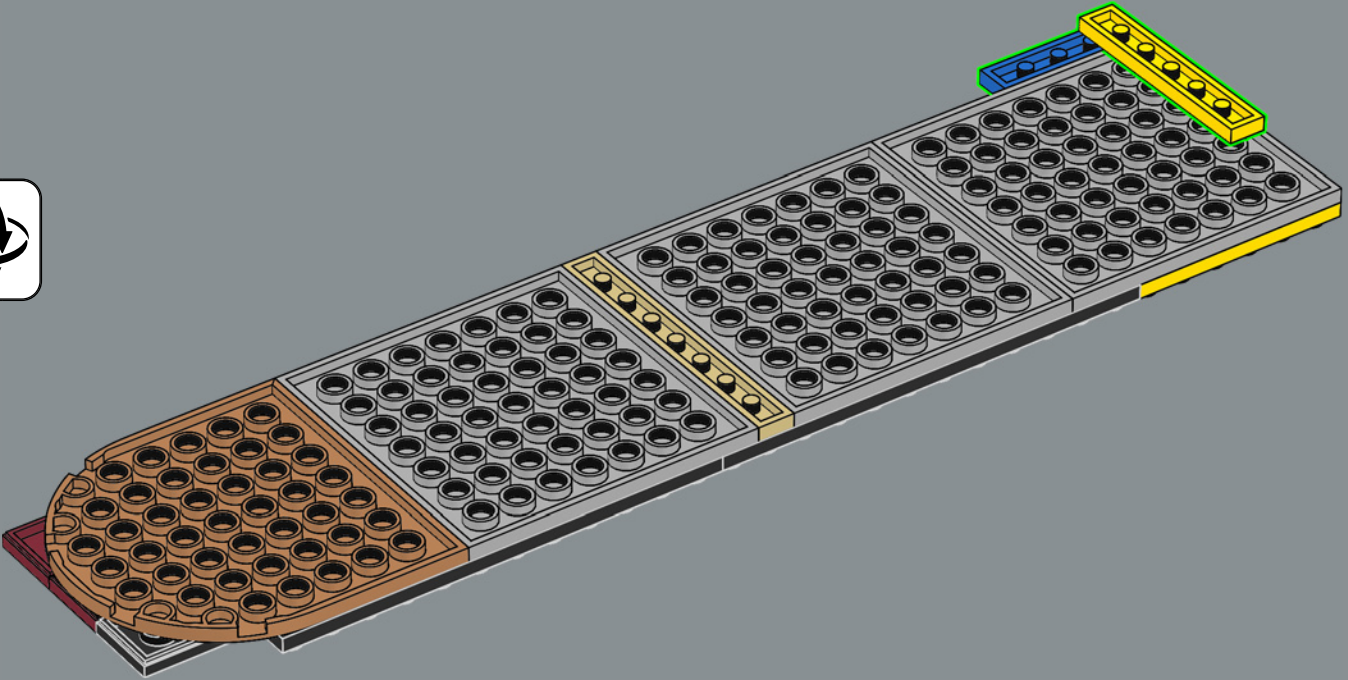

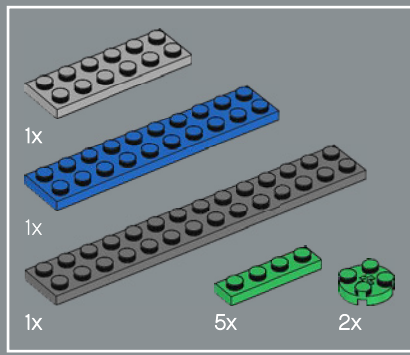

310

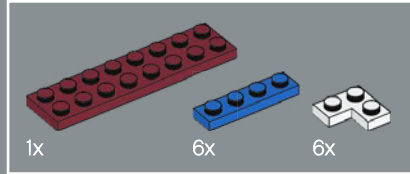
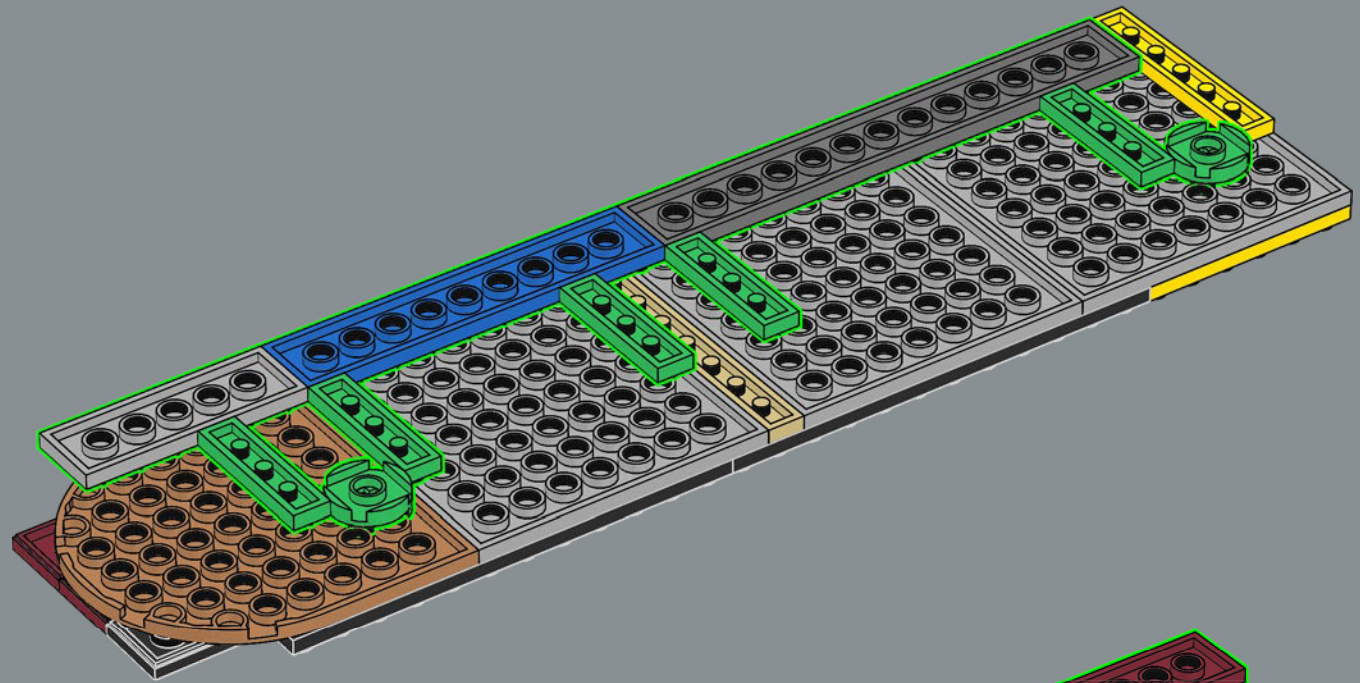

311

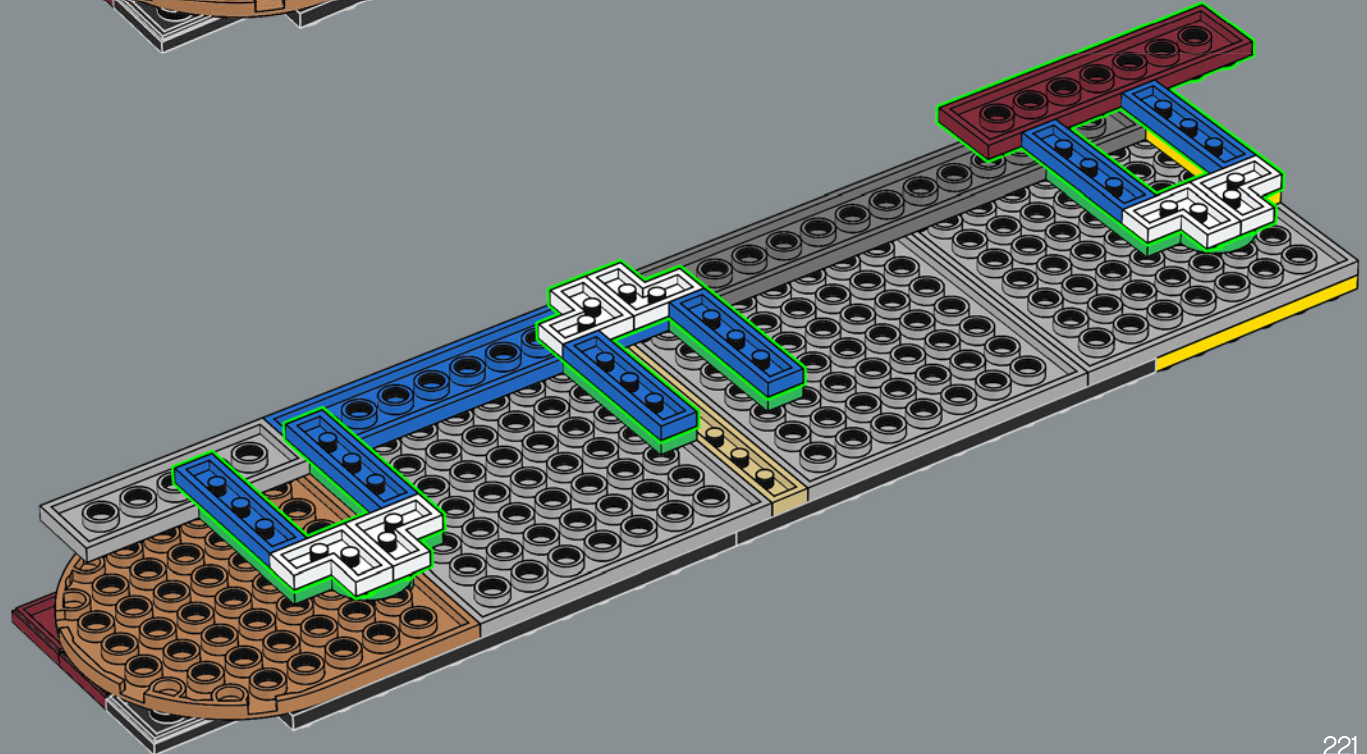

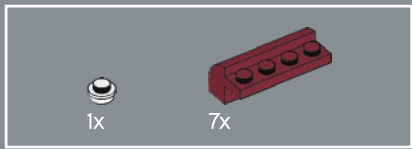

312

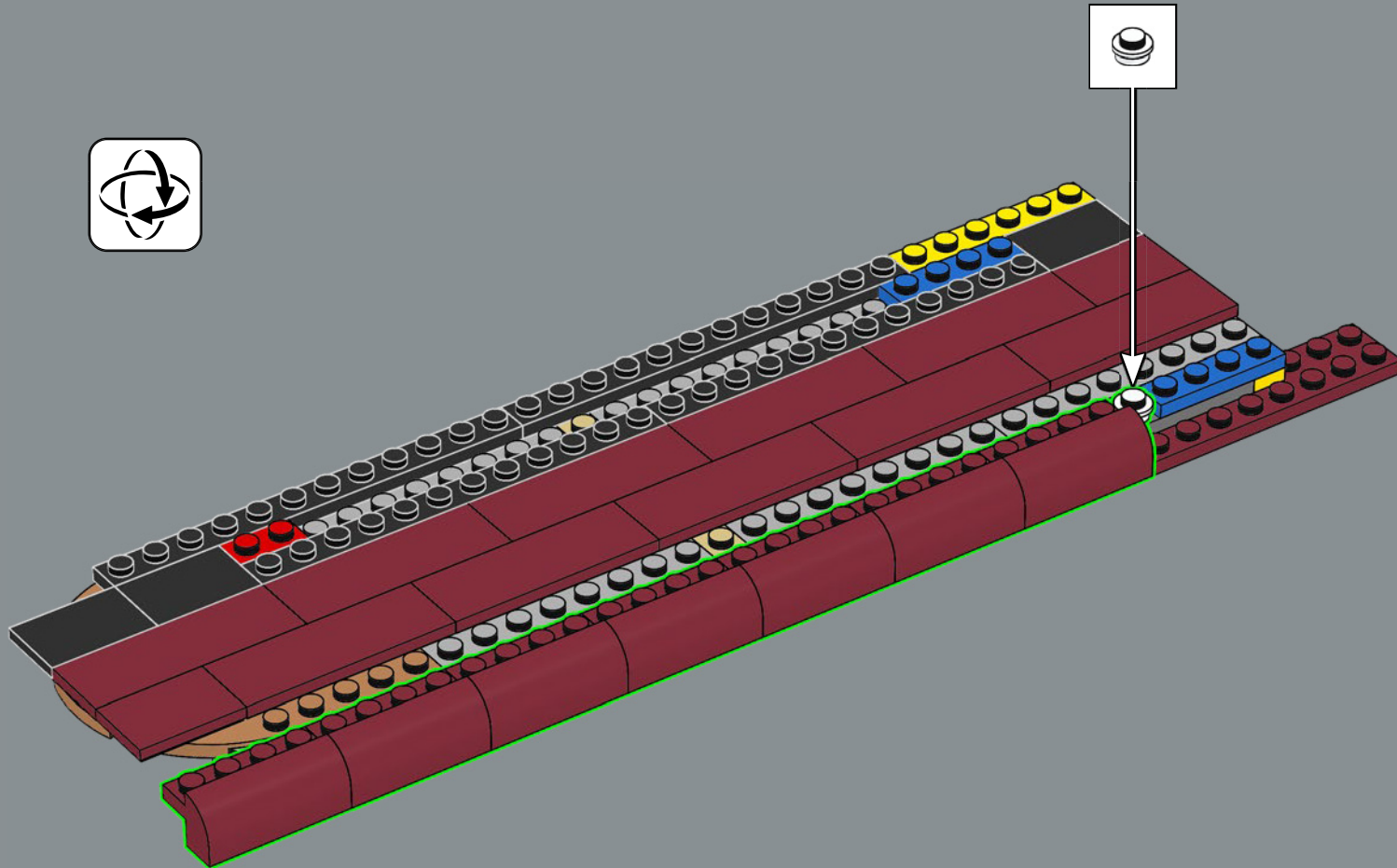

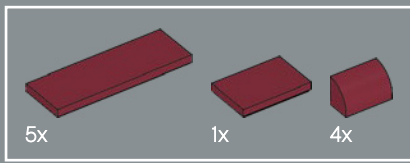

313

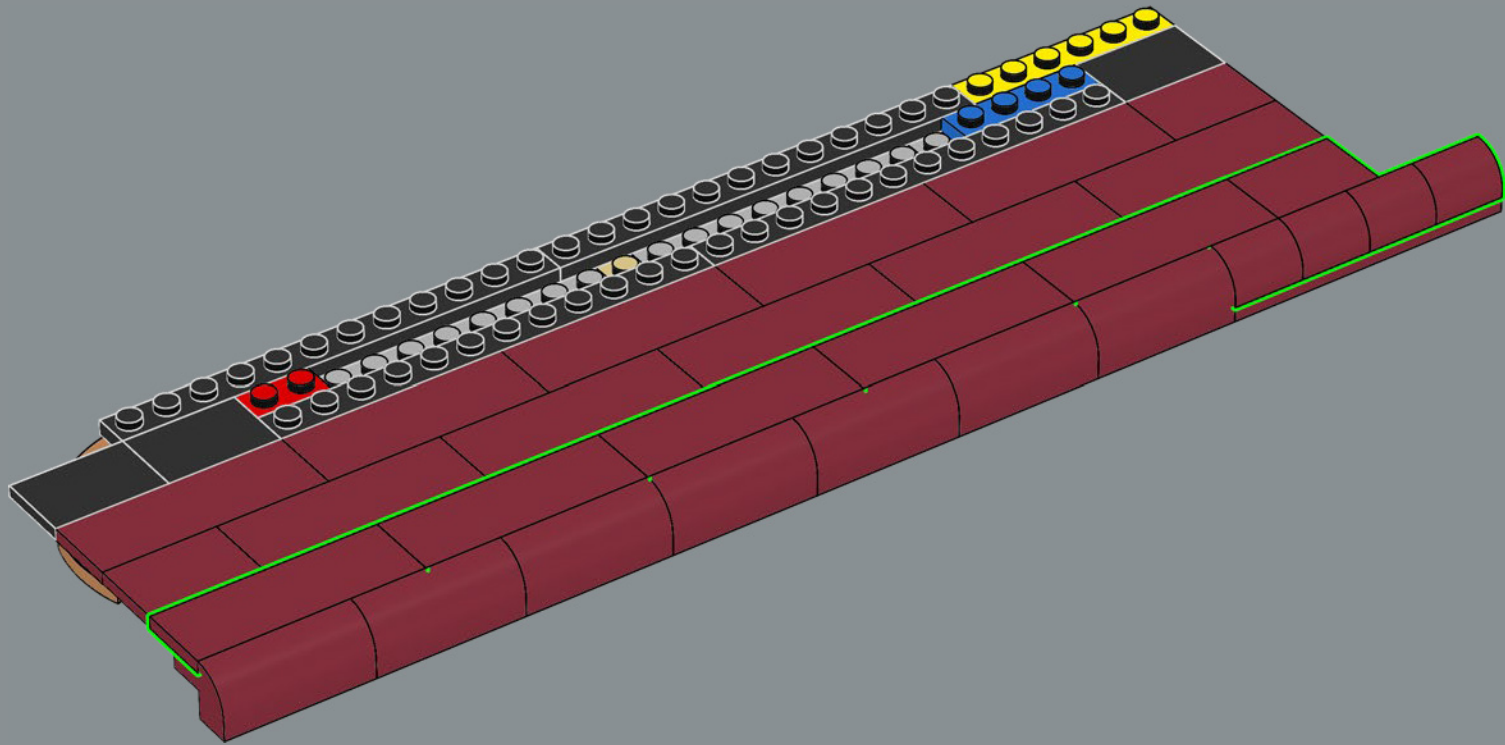



314

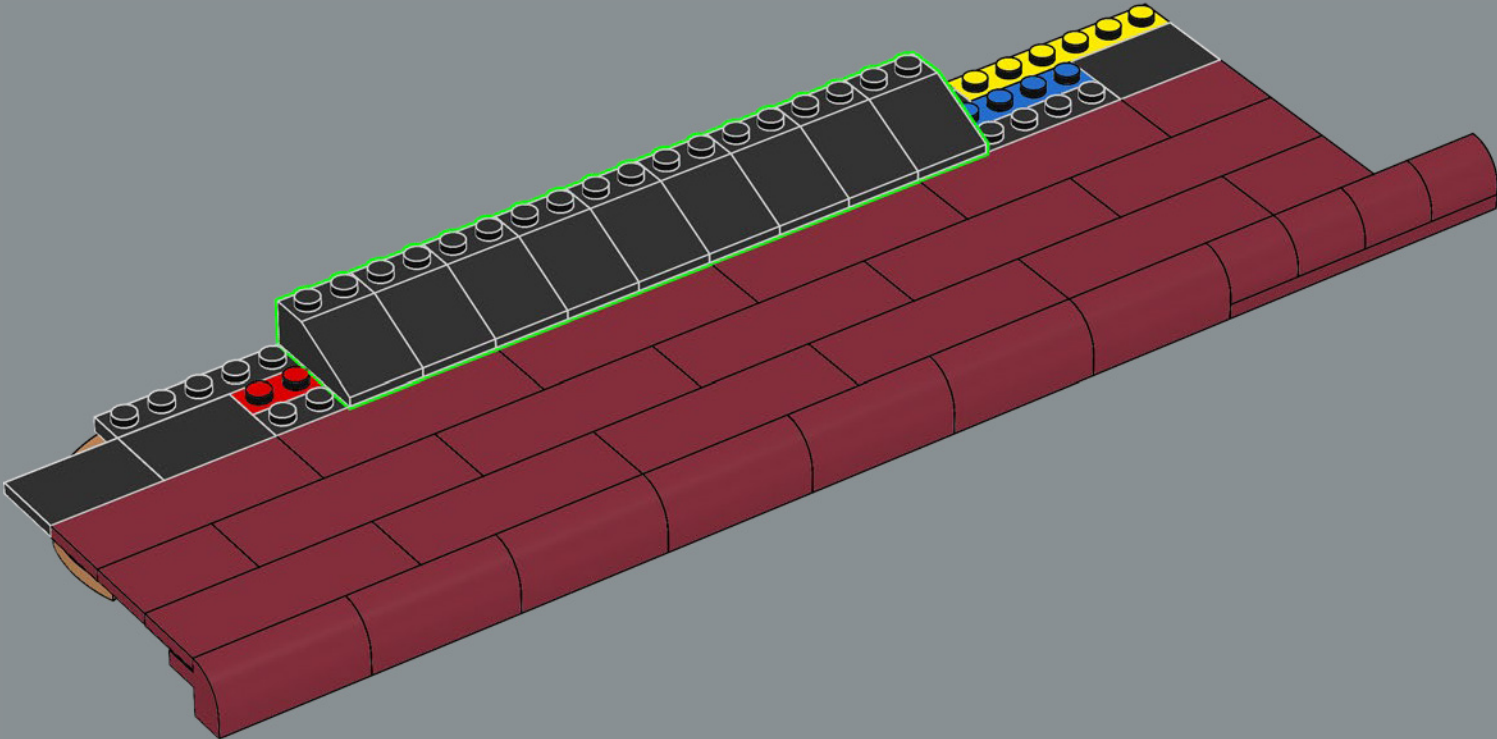

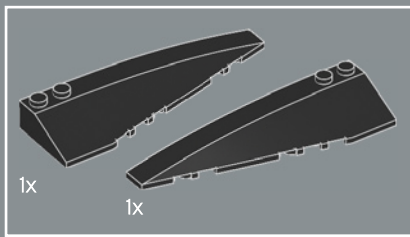

315

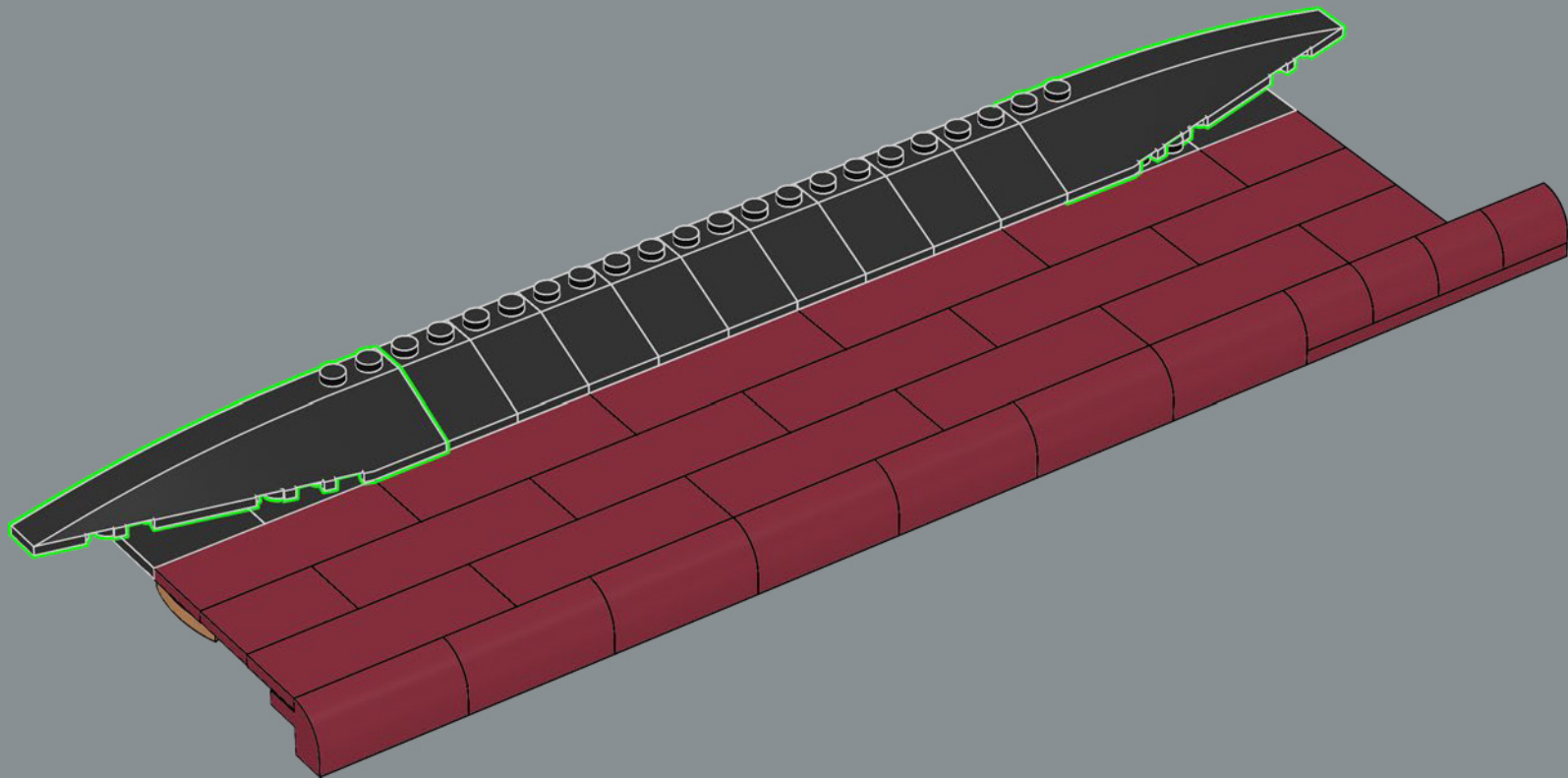

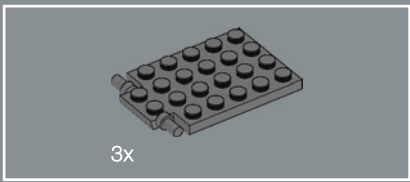

316

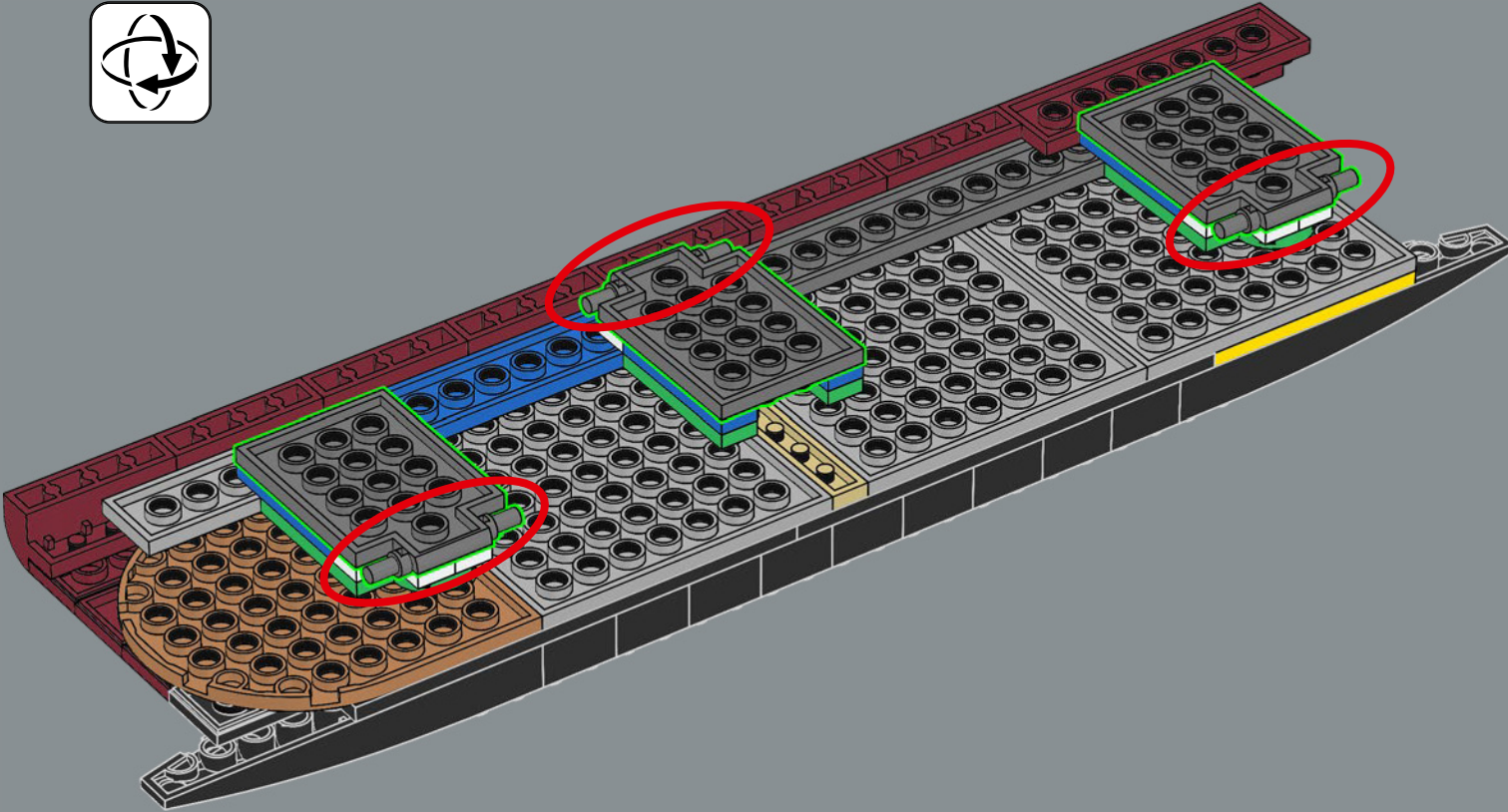



317

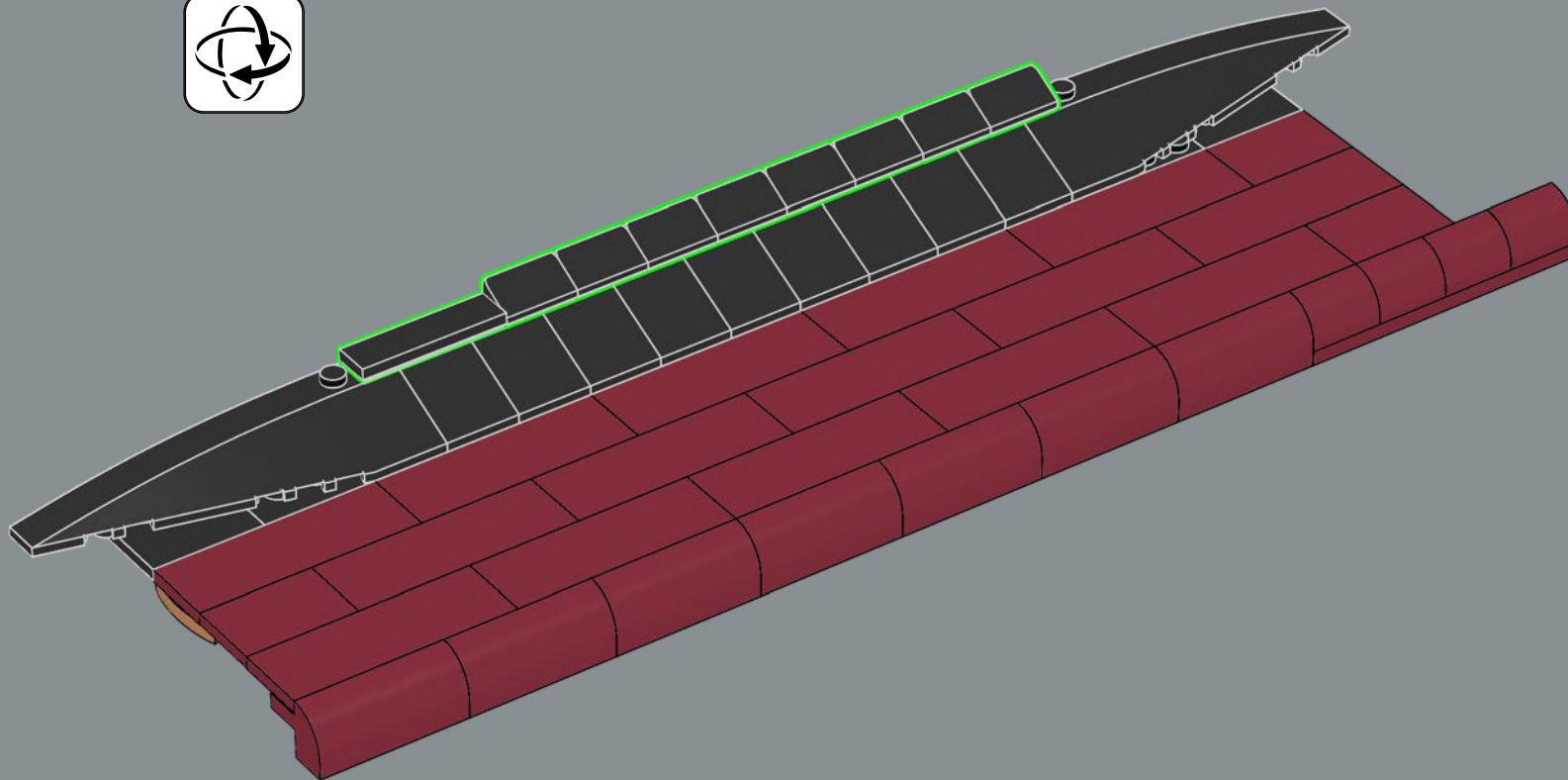

318

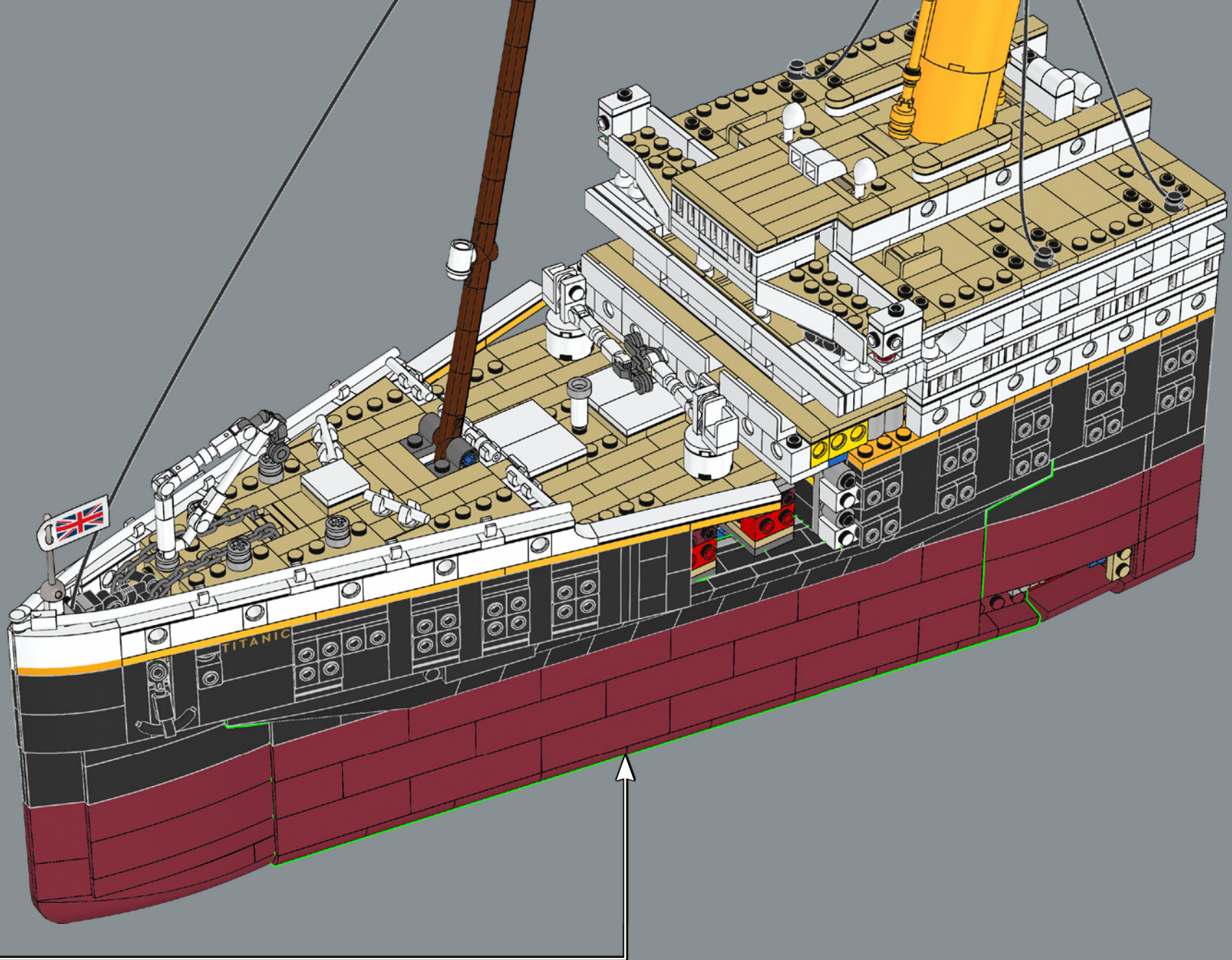

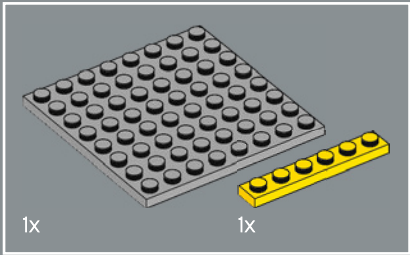
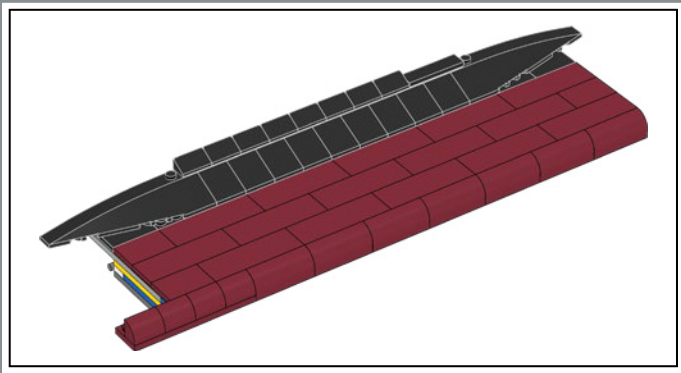

319

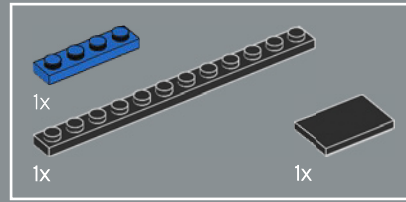
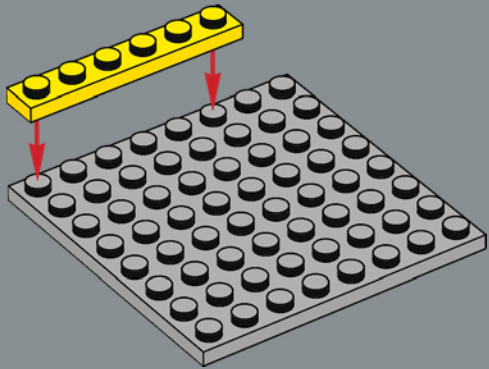

320

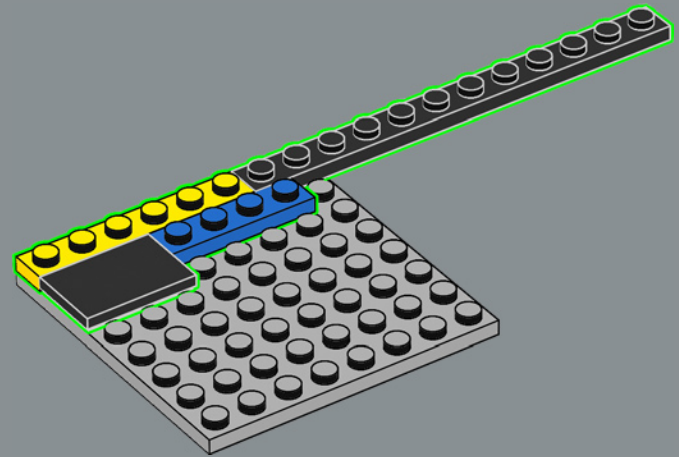

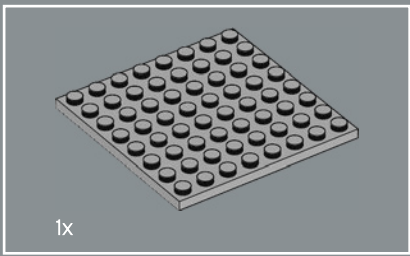

321

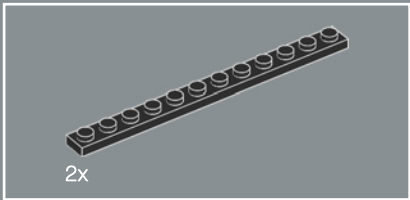
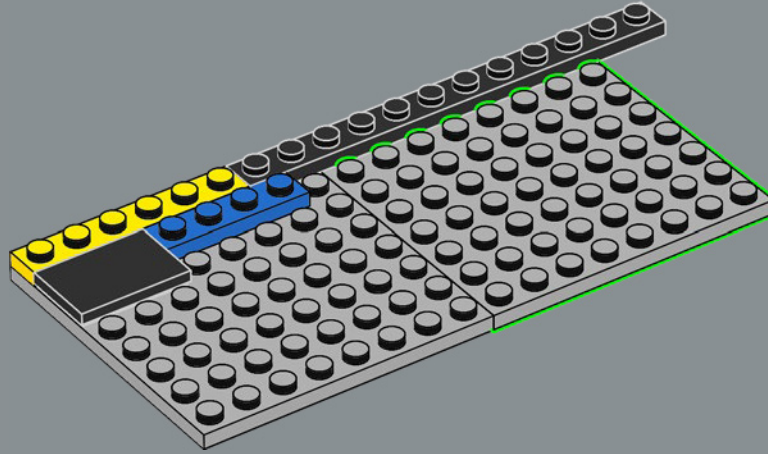

322

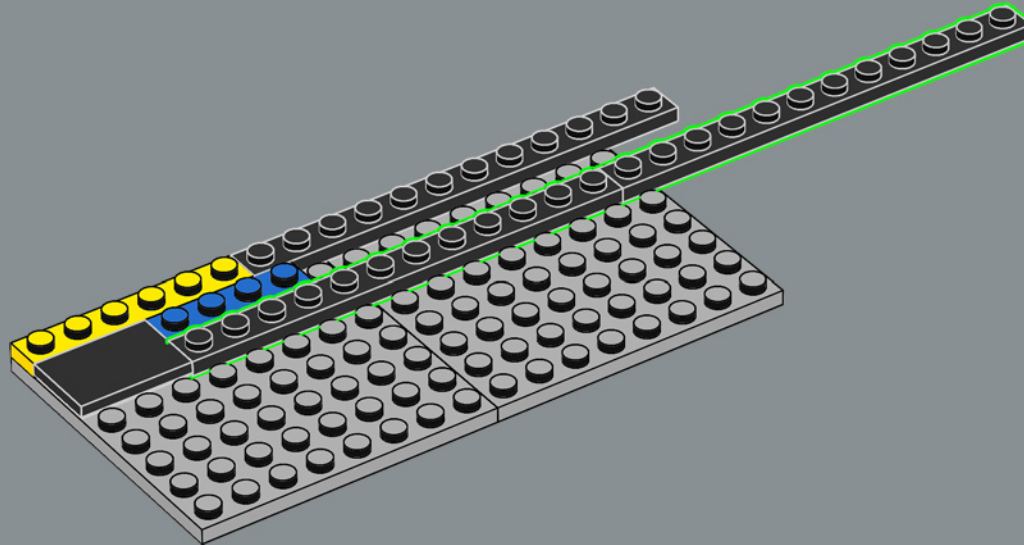

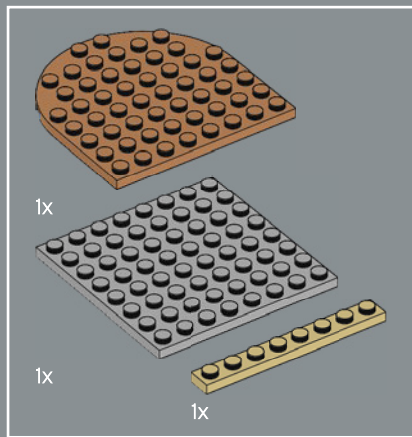

323

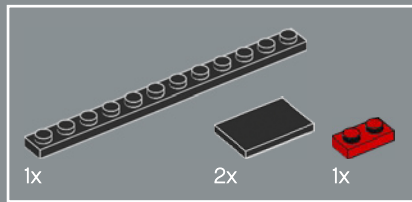
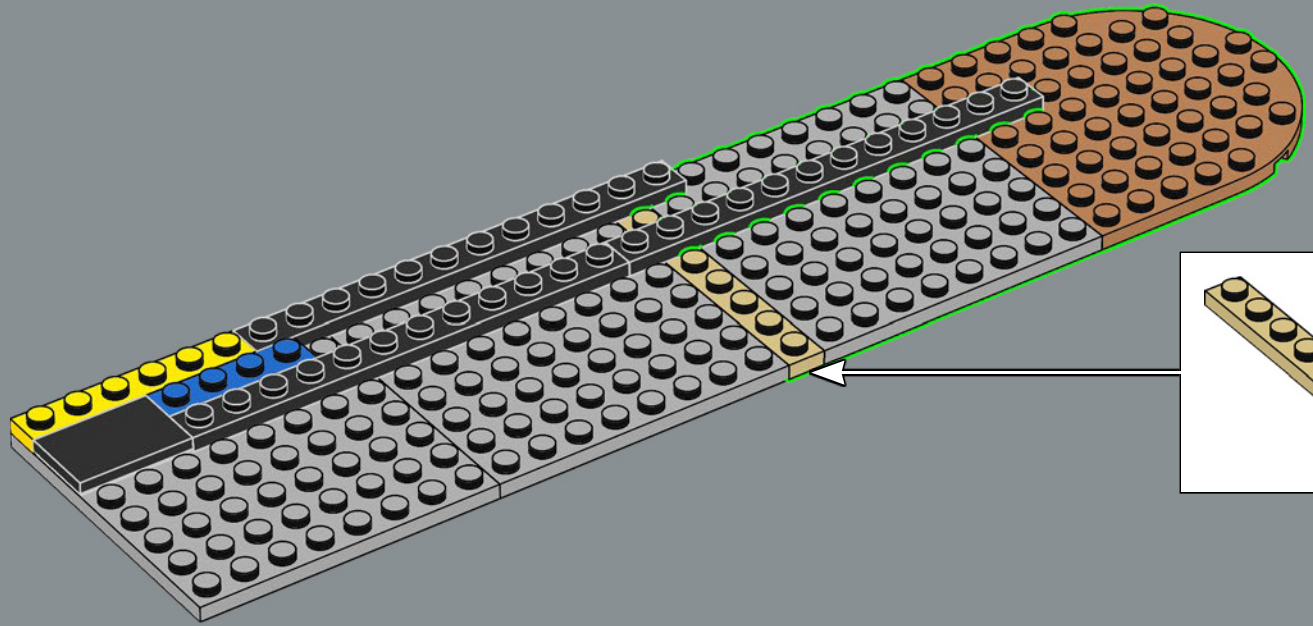

324

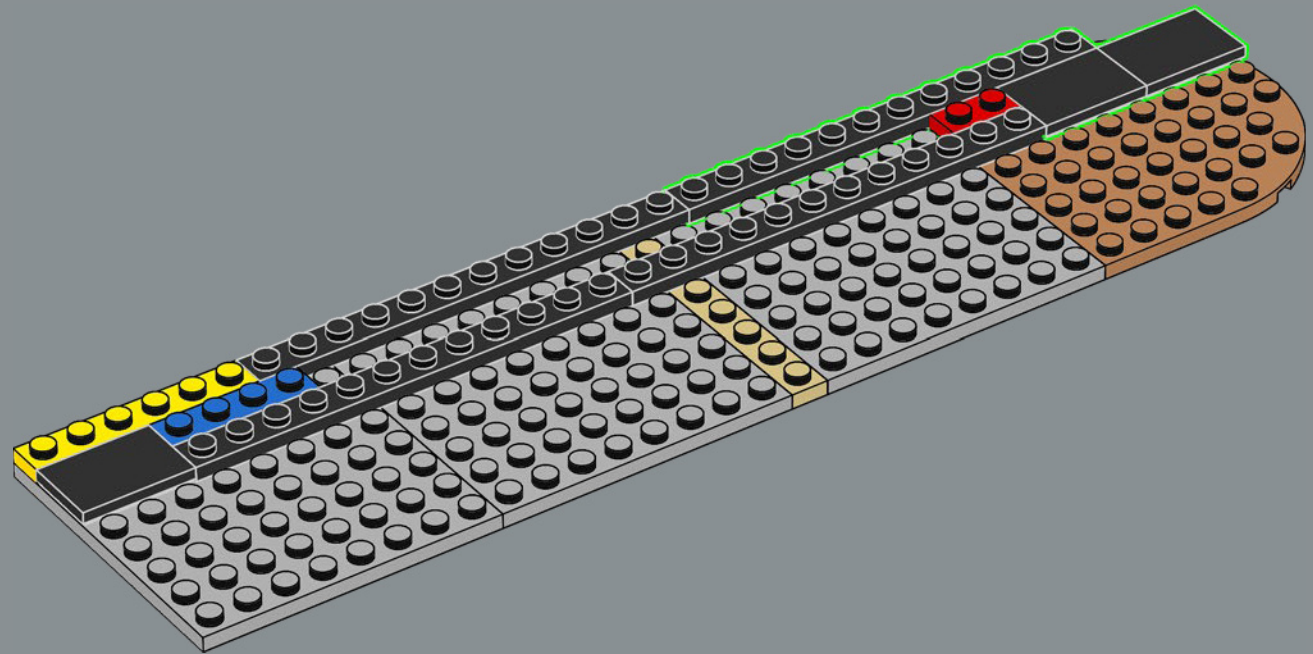

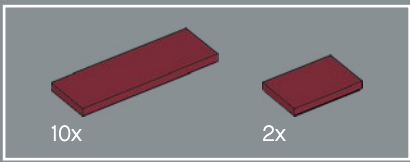

325

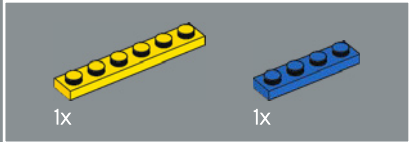
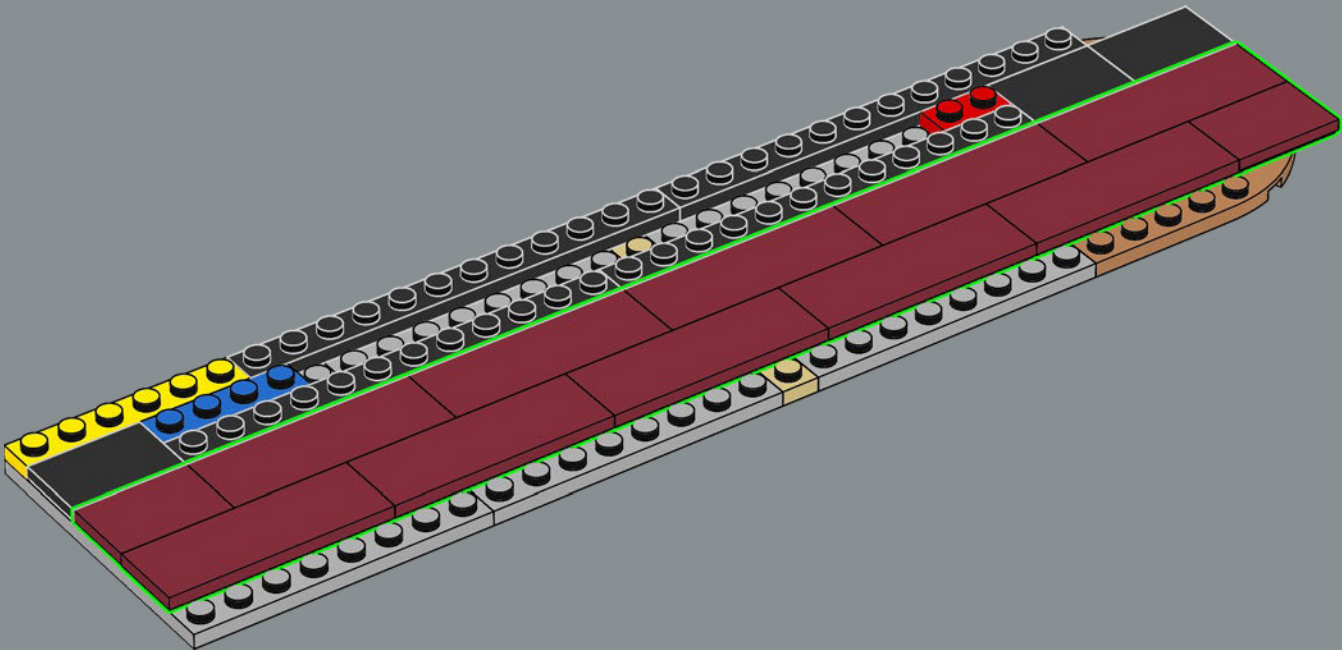

326

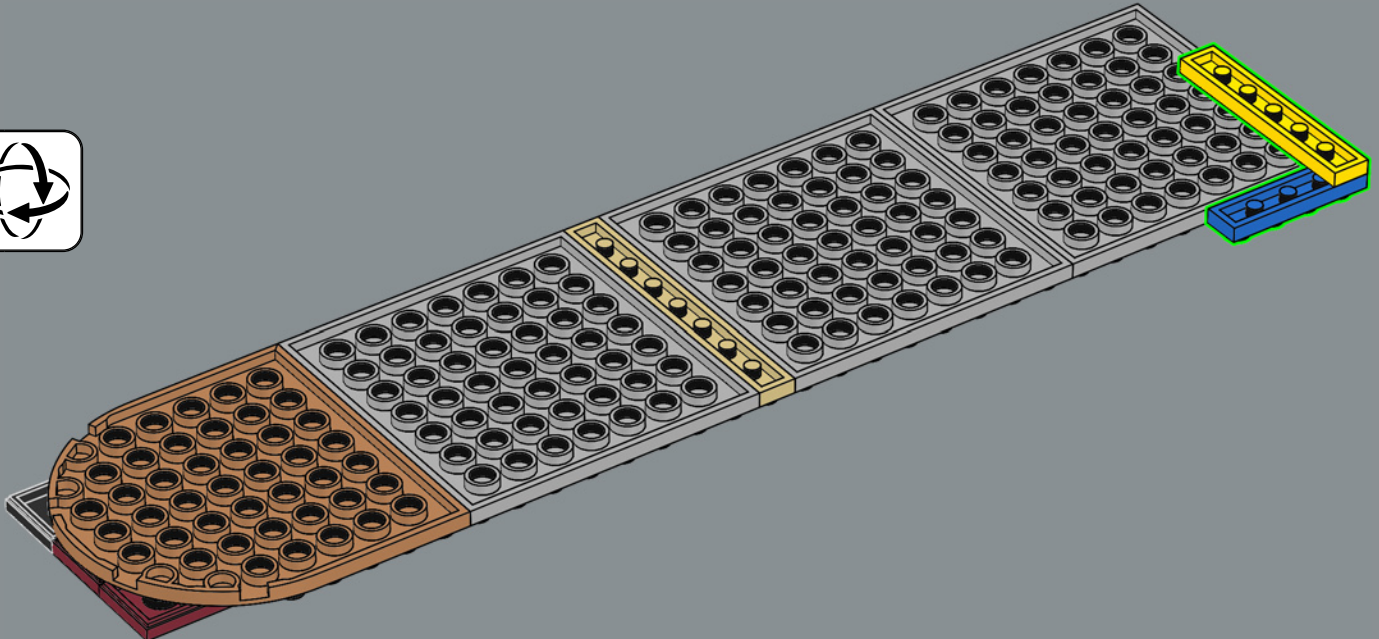

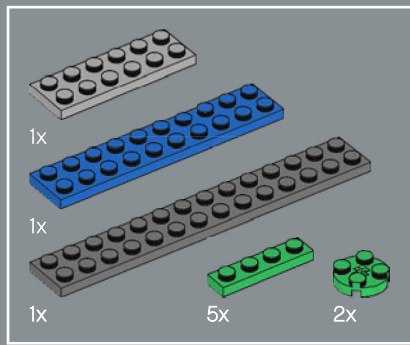

327

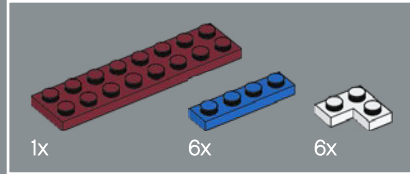
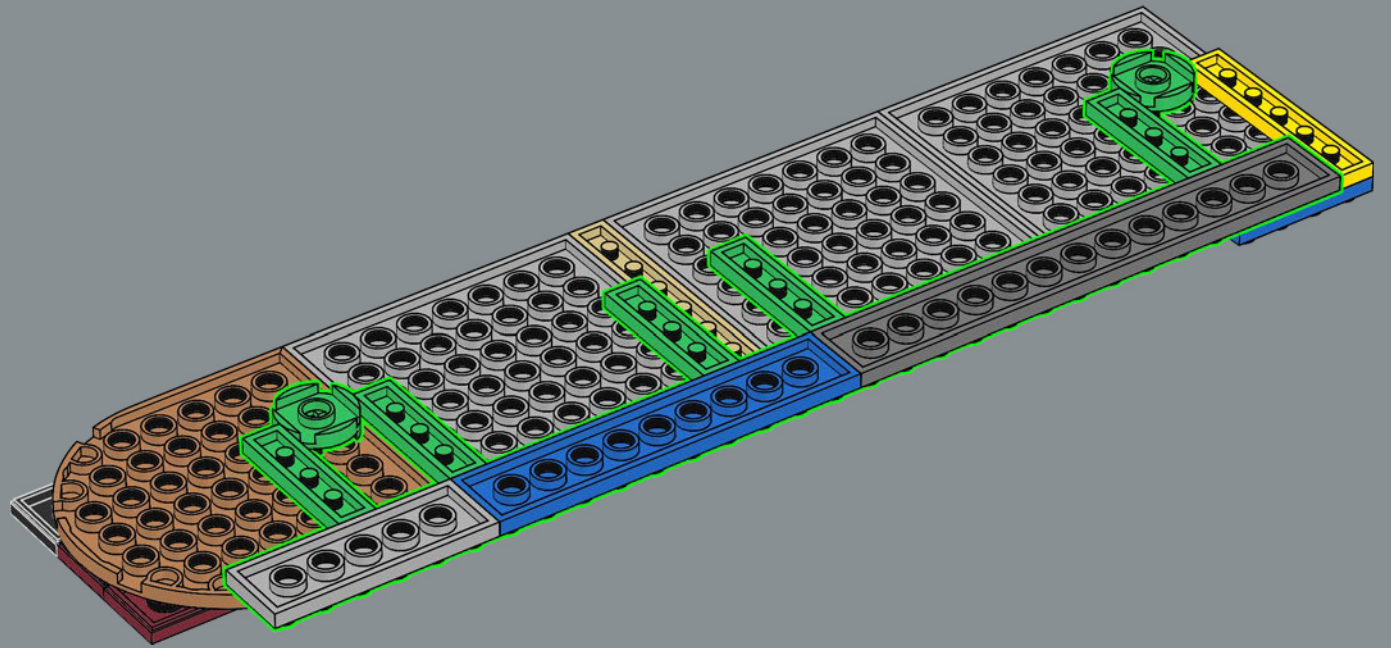

328

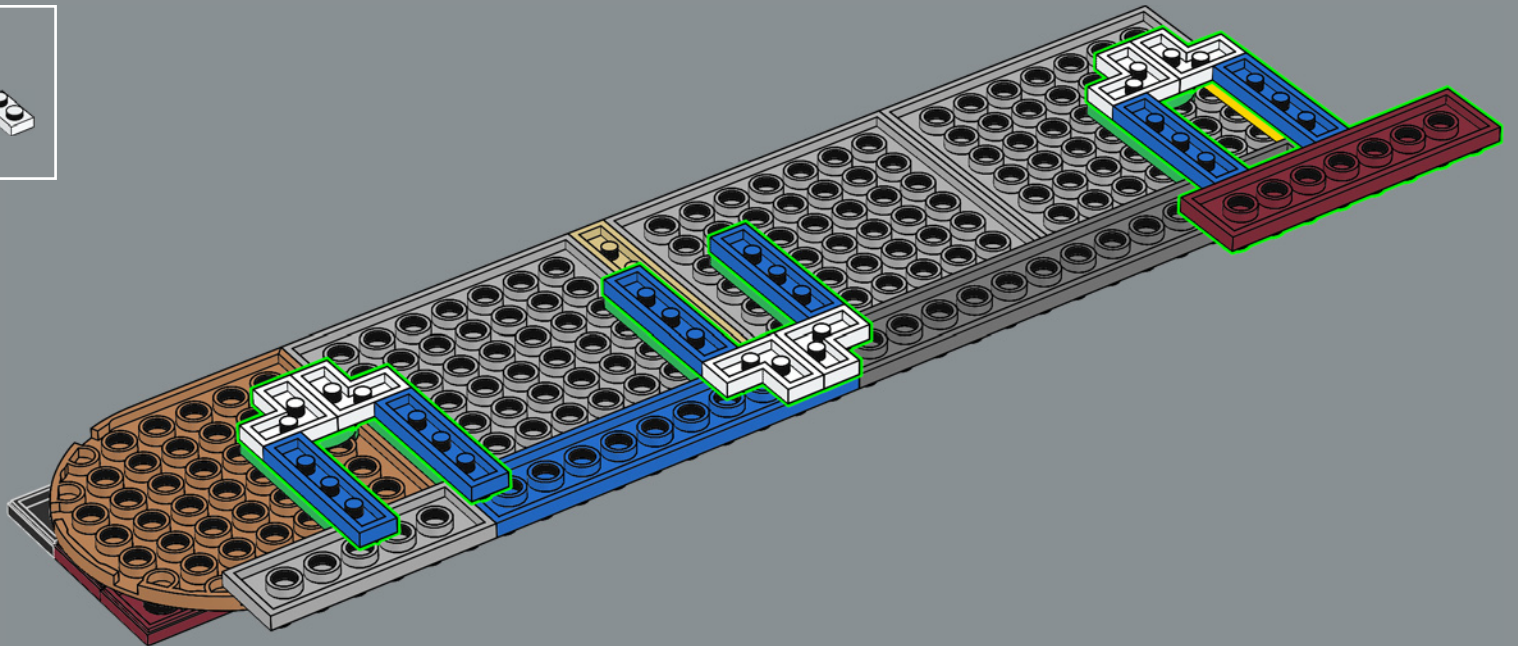

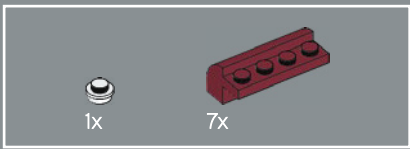

329

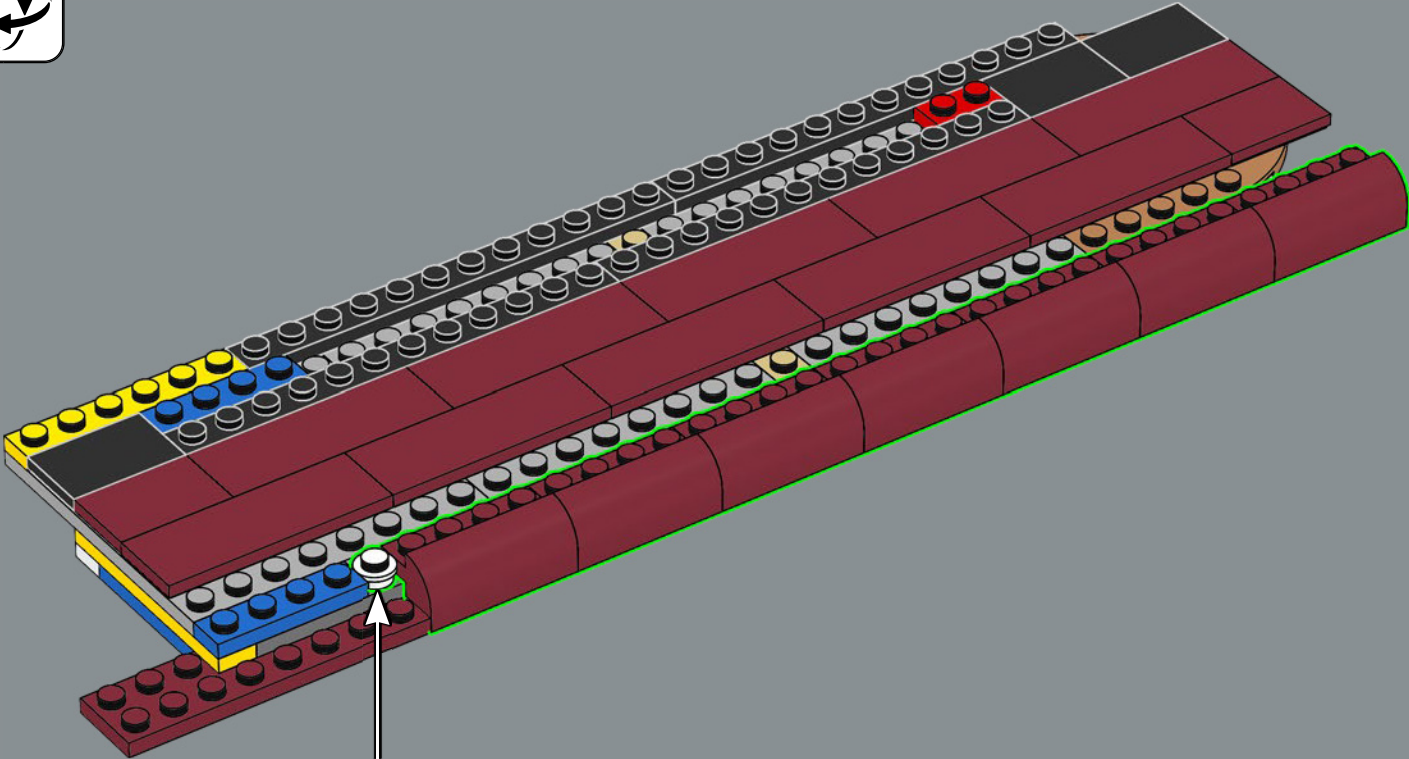

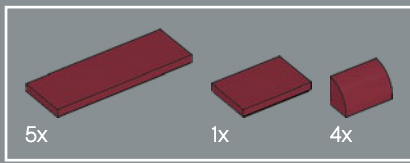

330

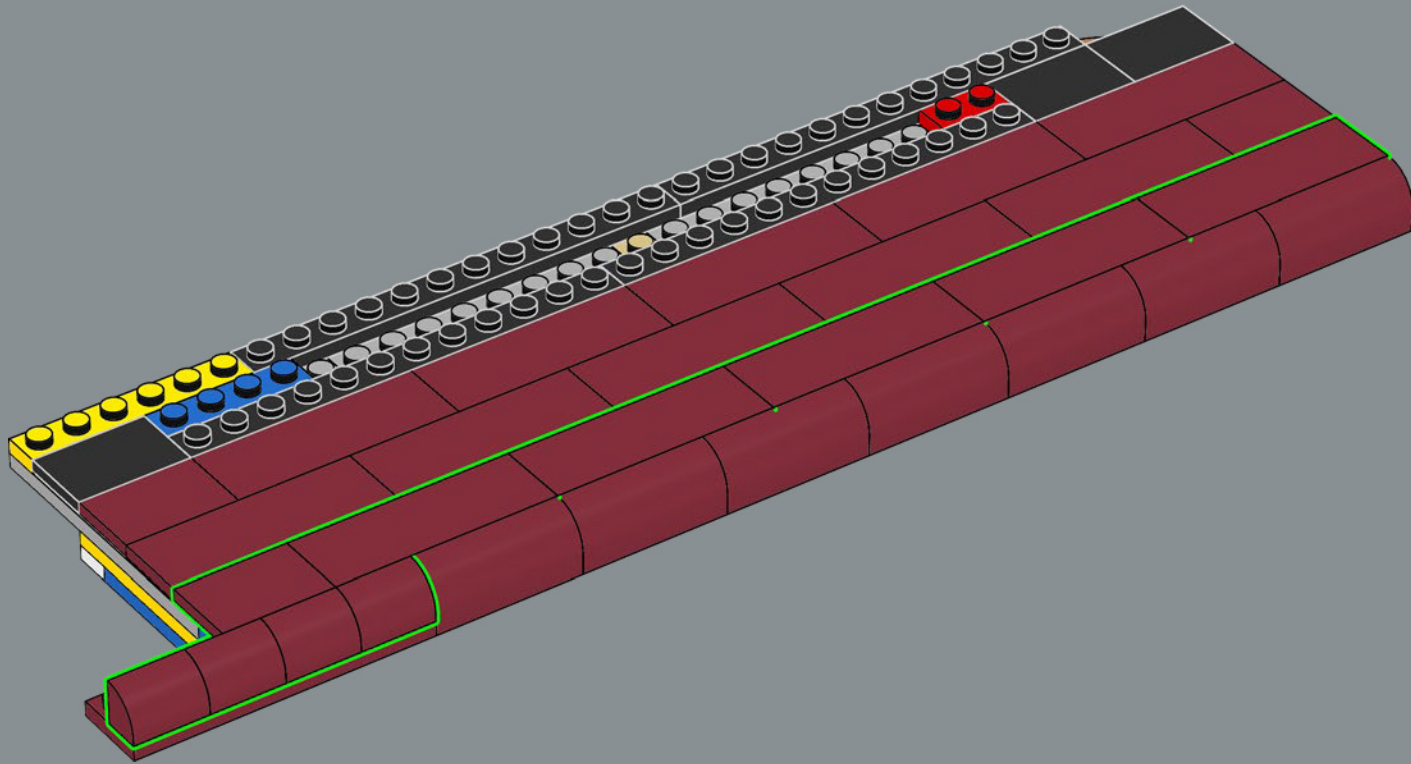

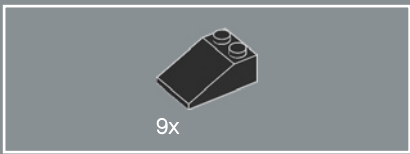

331

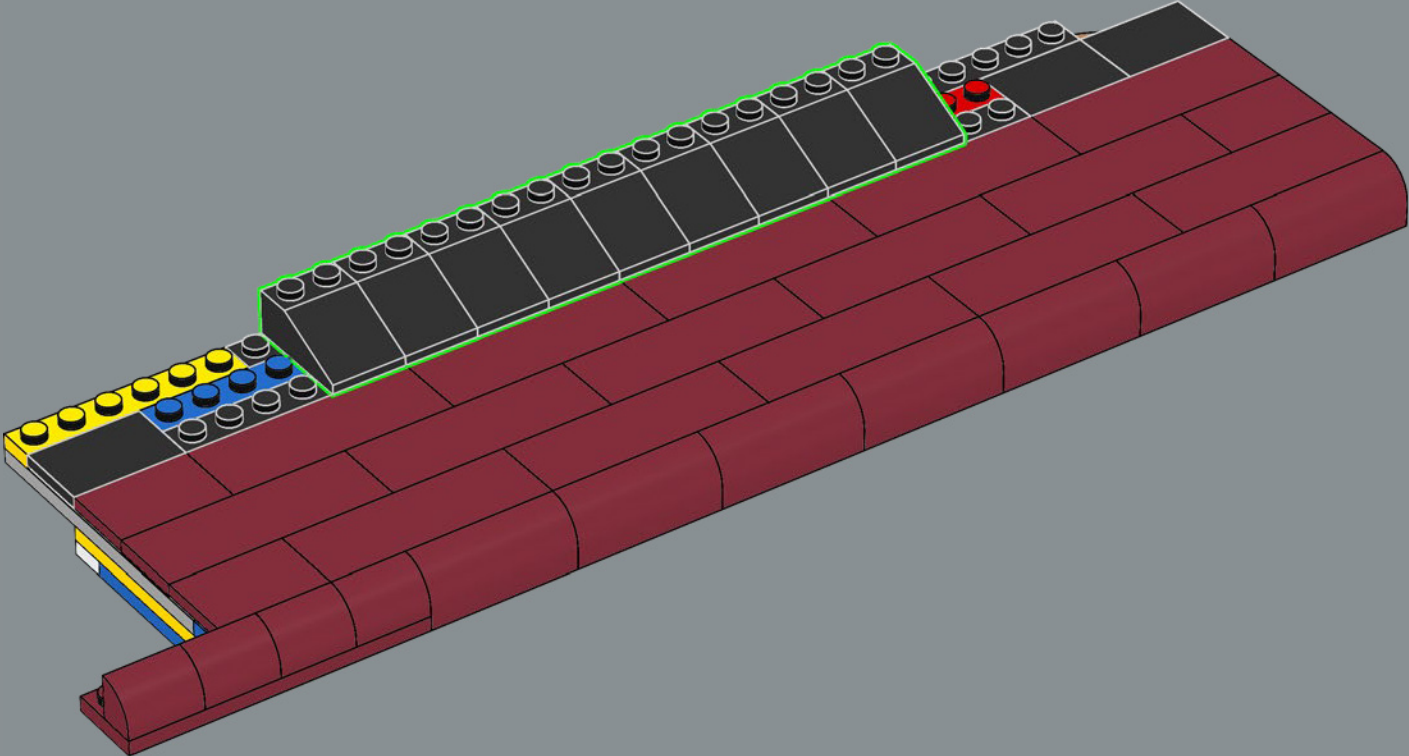

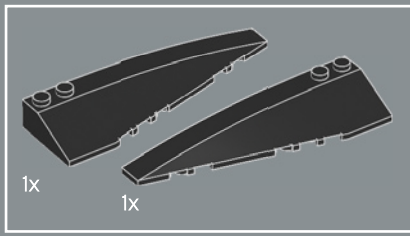

332

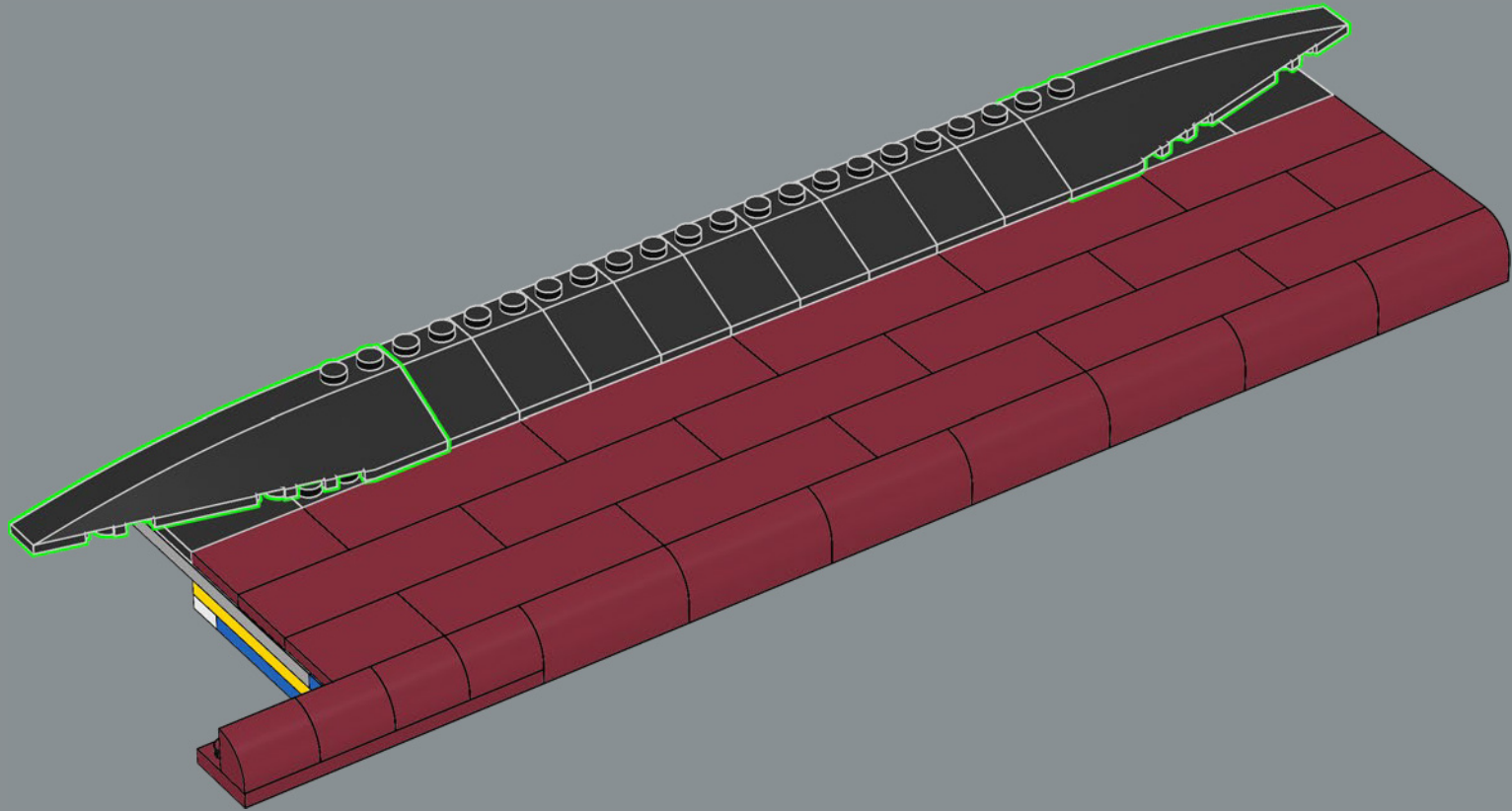

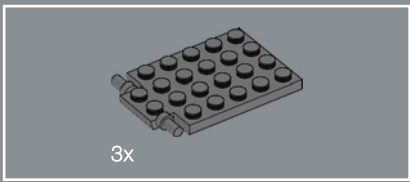

333

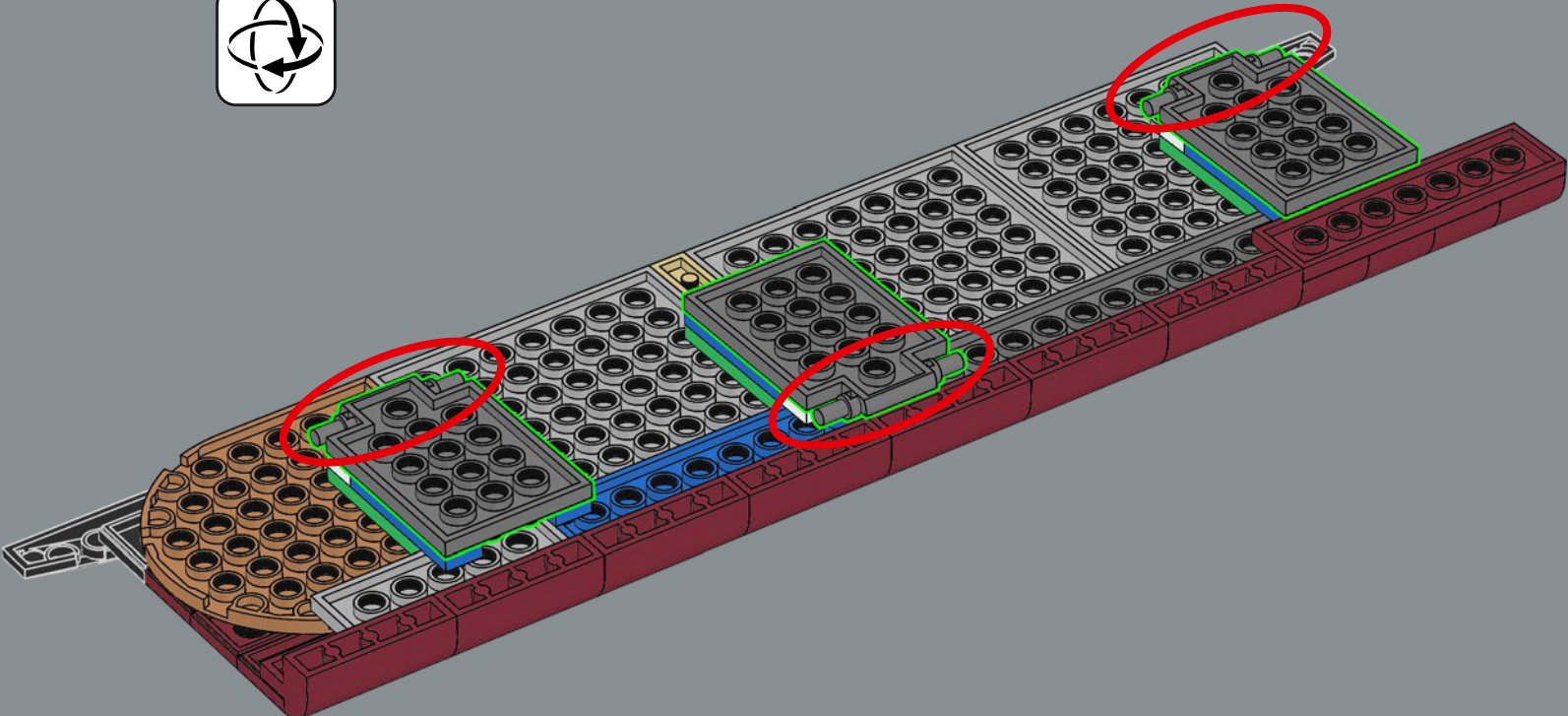



334

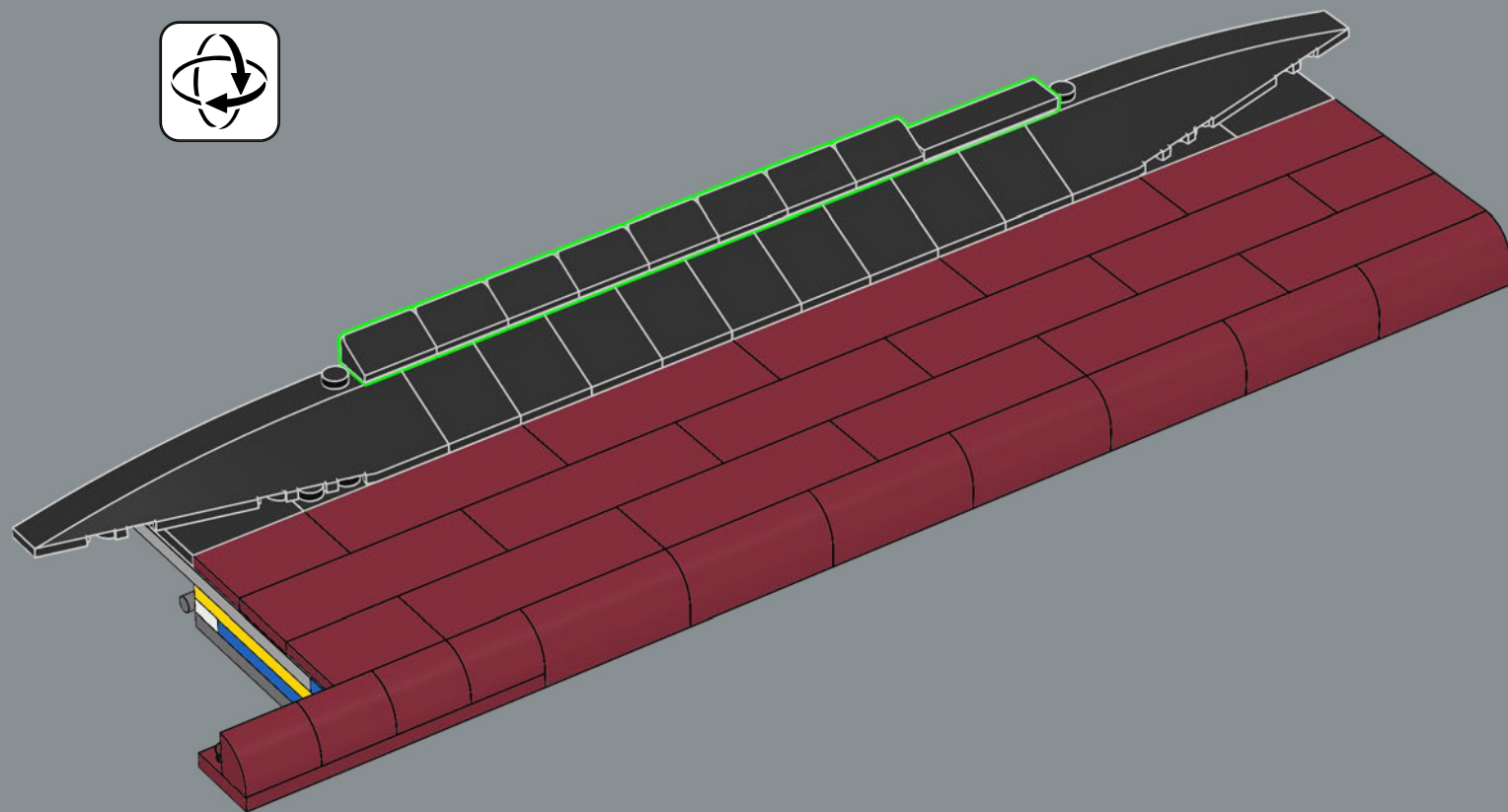

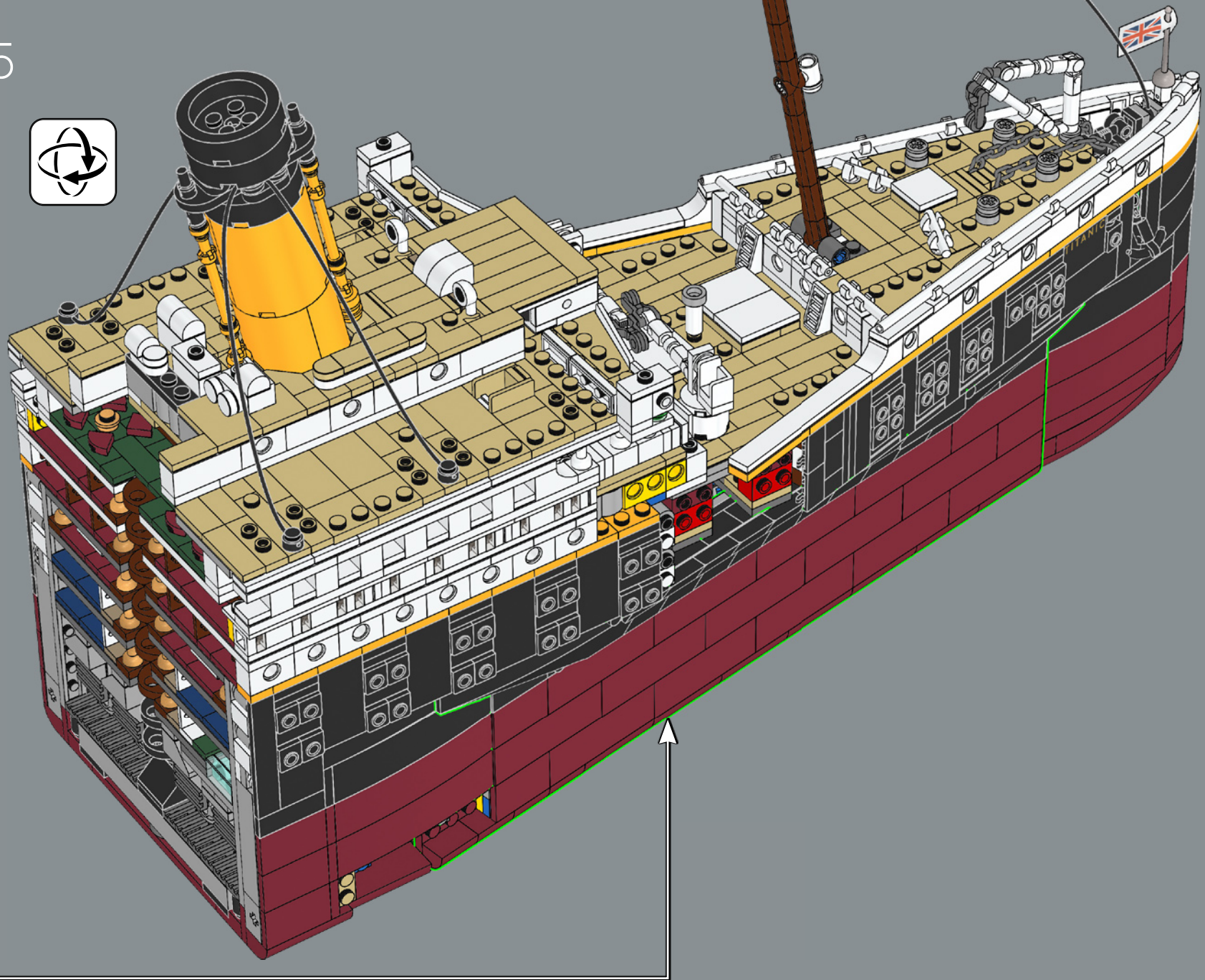

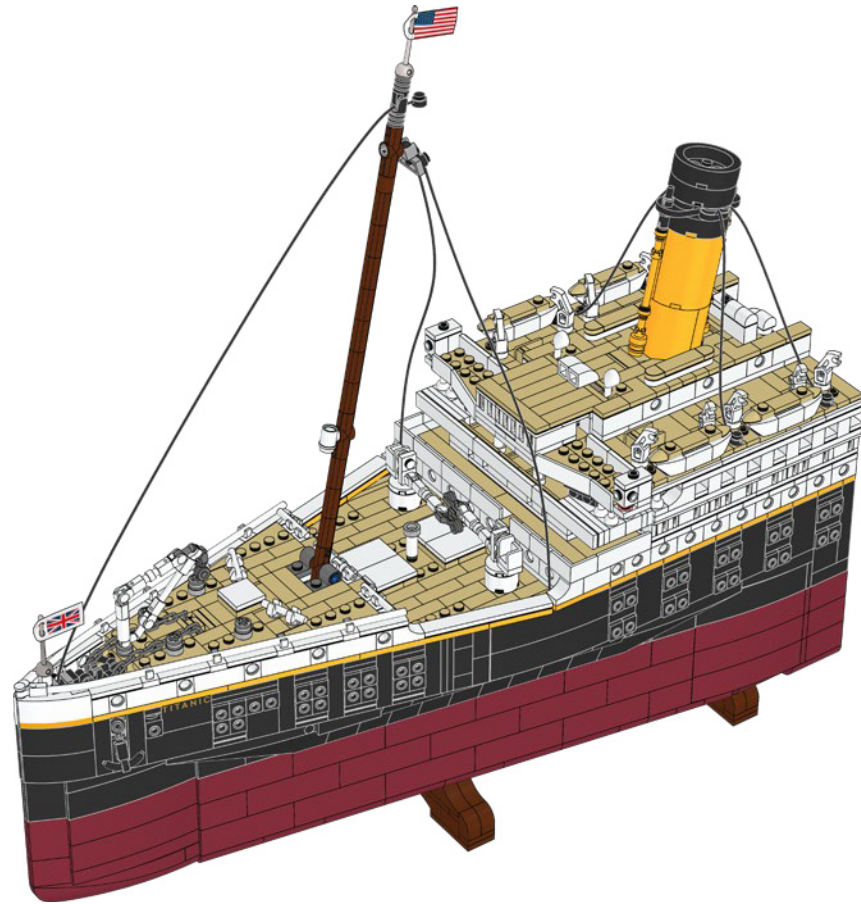
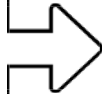

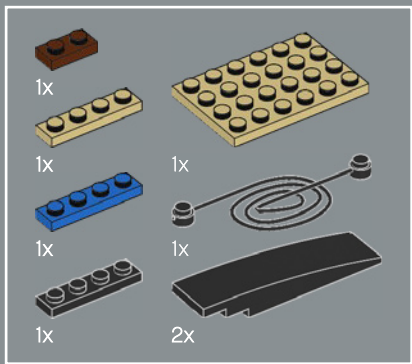

336

1

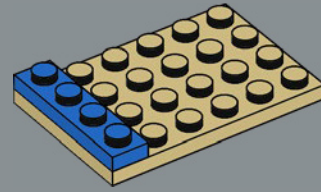

2

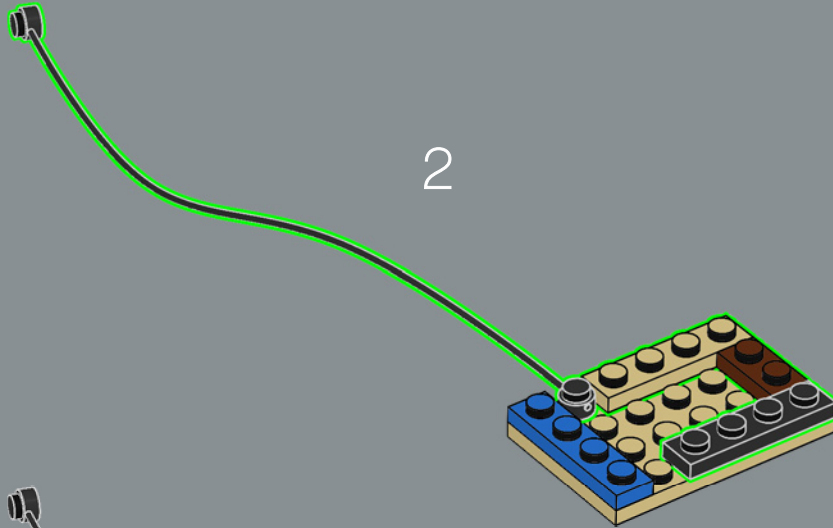

3

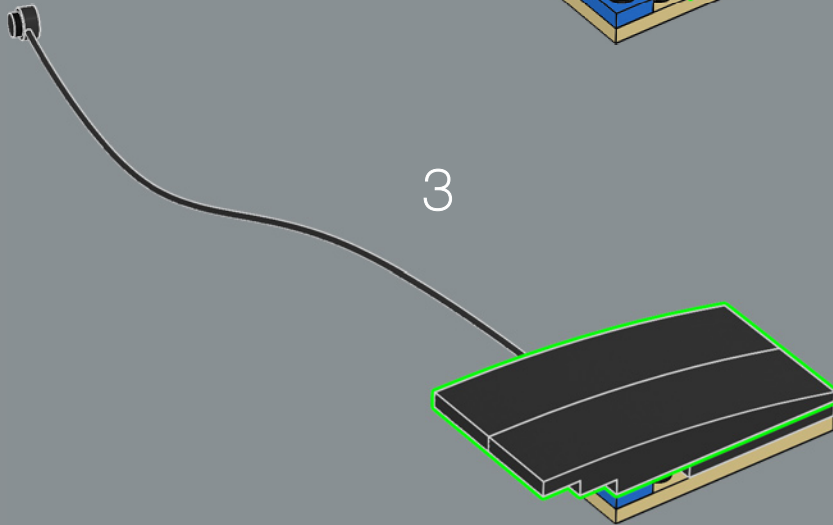

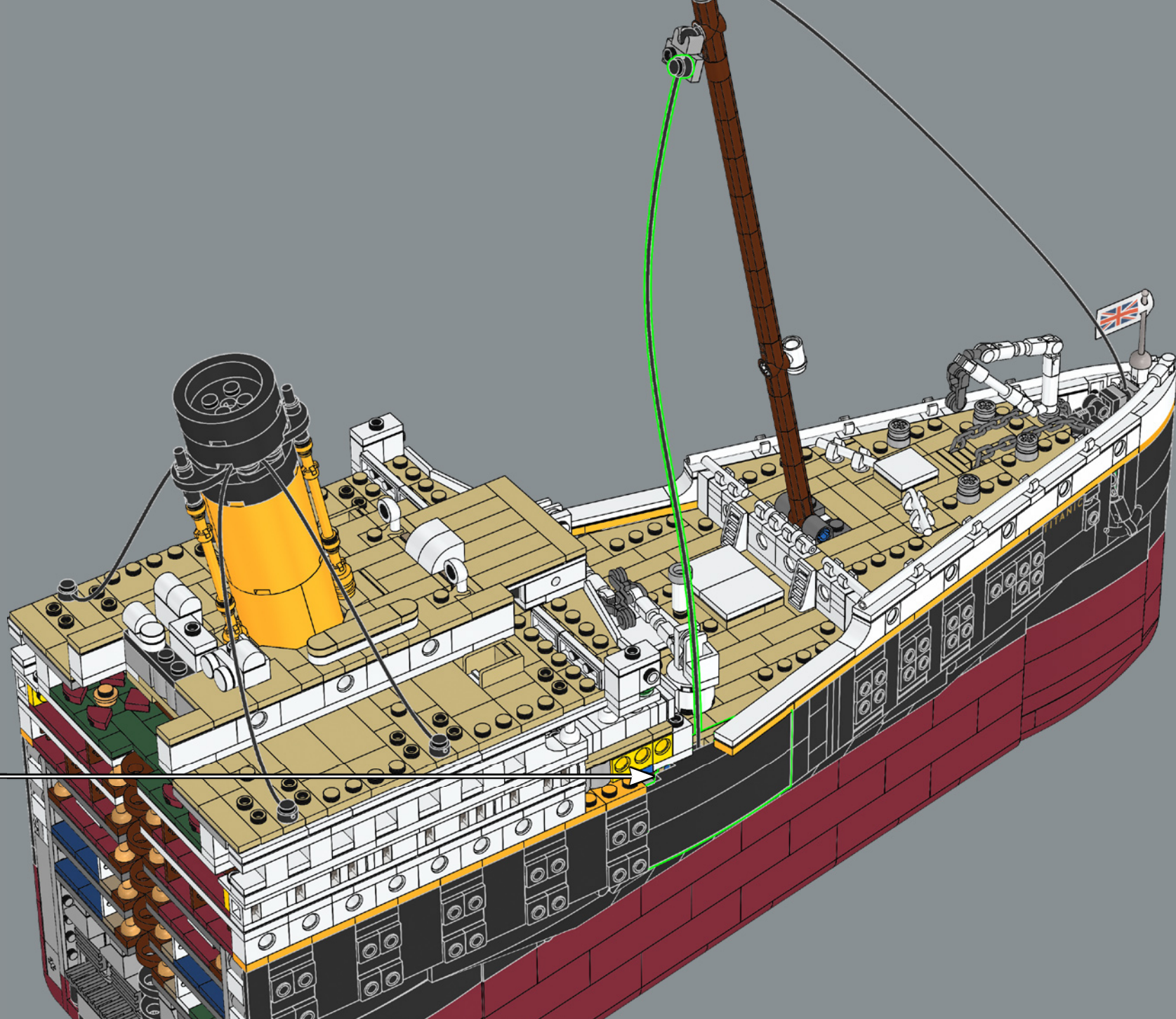

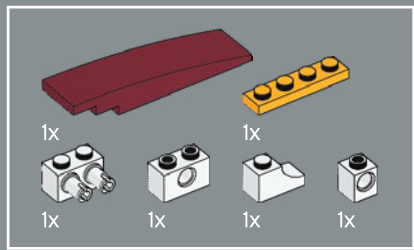

337

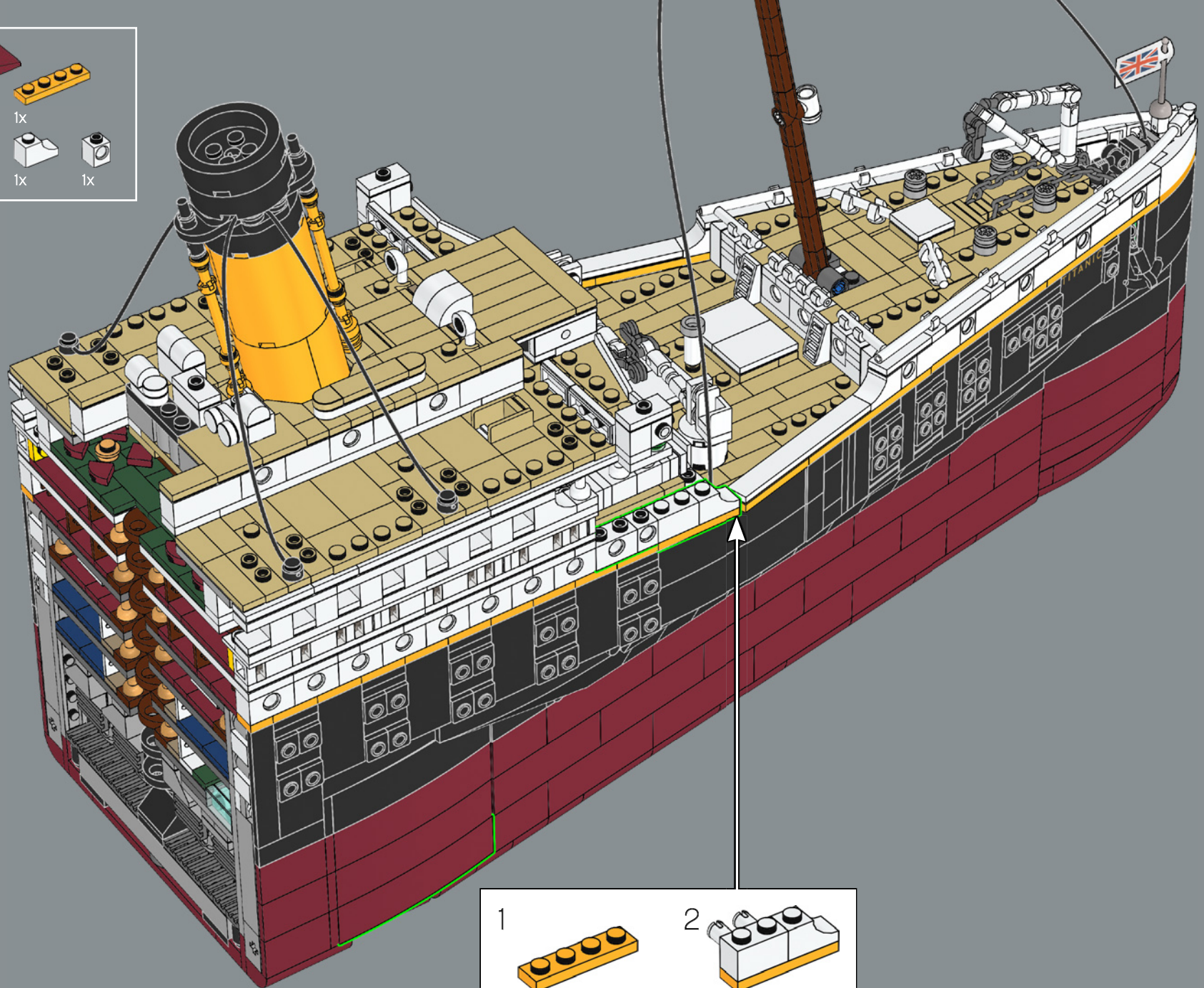

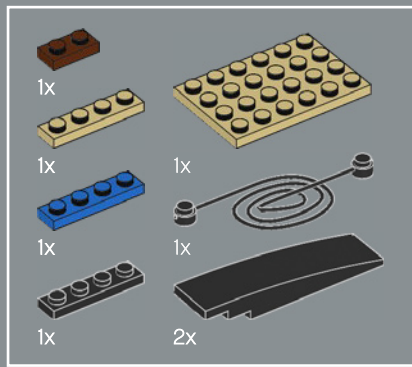

338

1

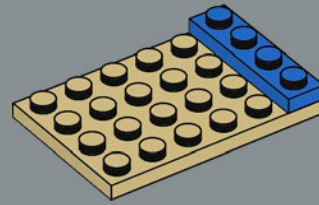

2

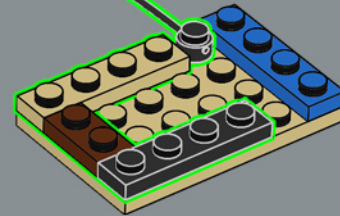

3

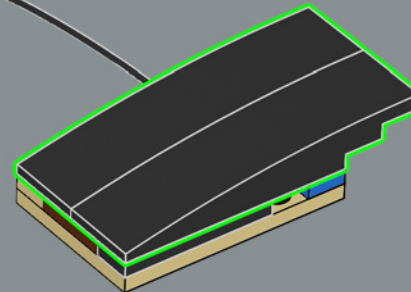

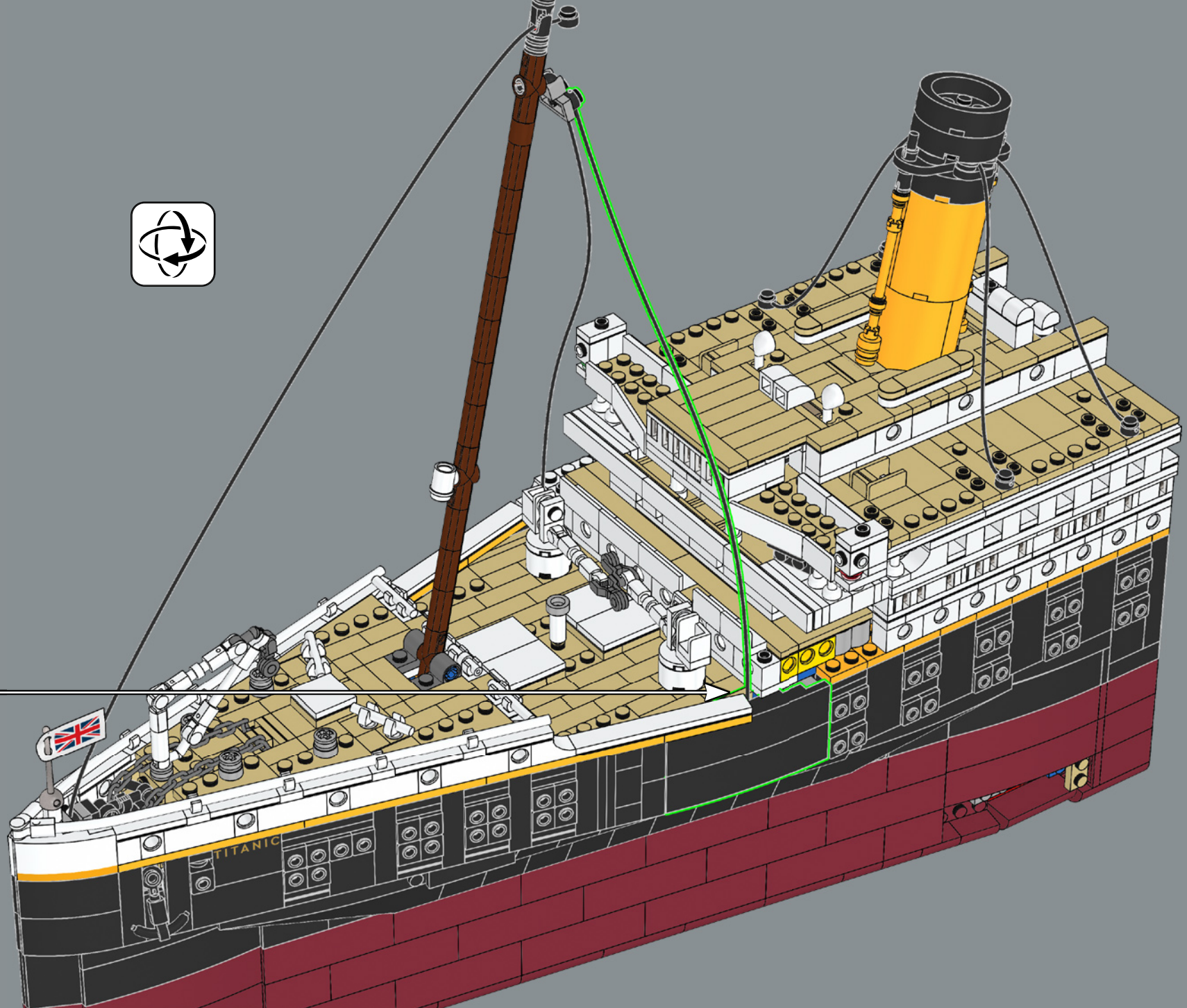

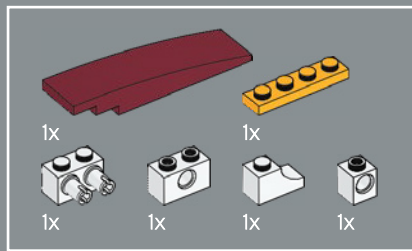

339

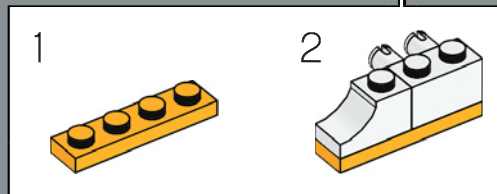
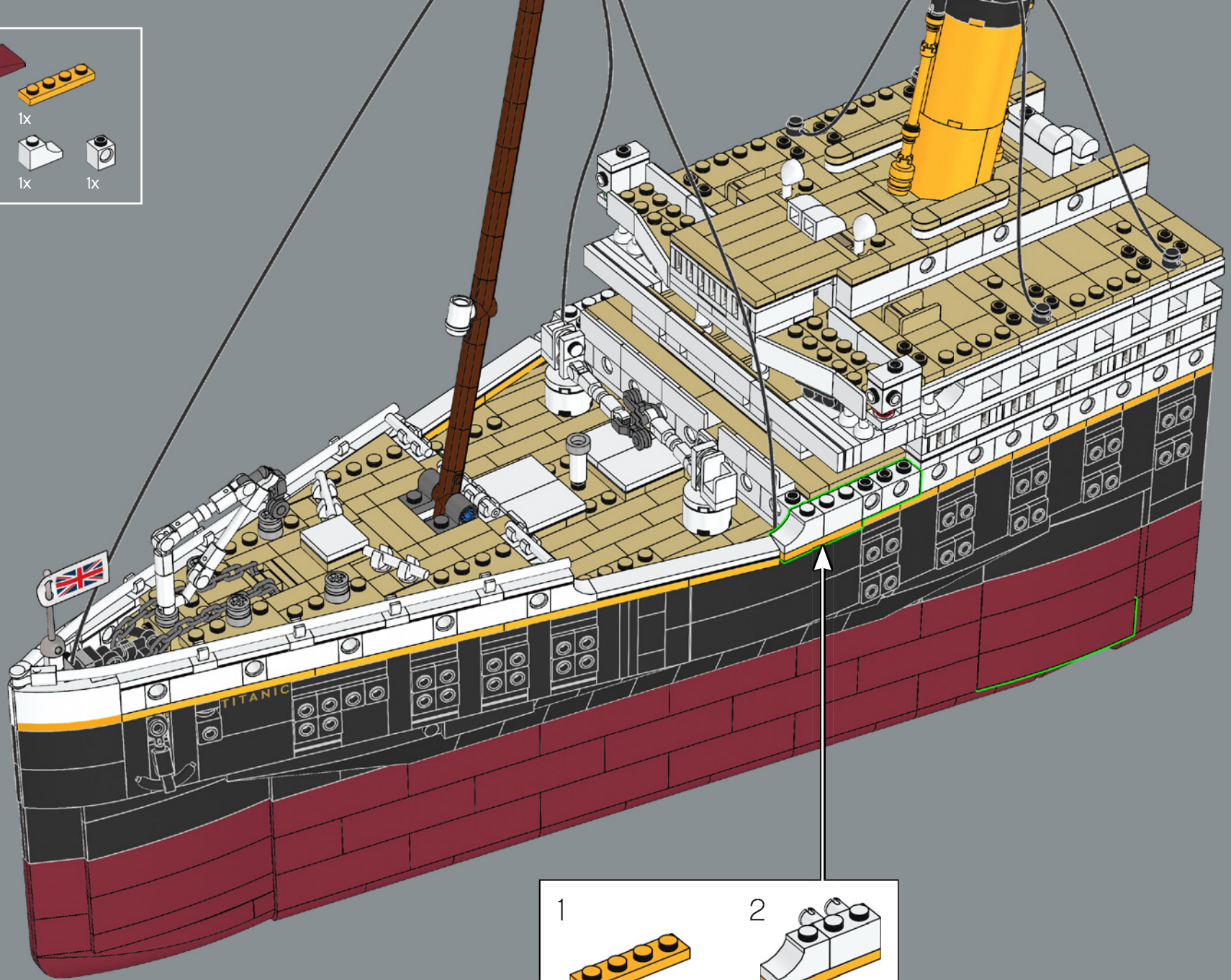

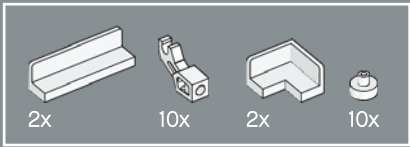

340

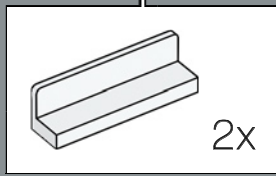
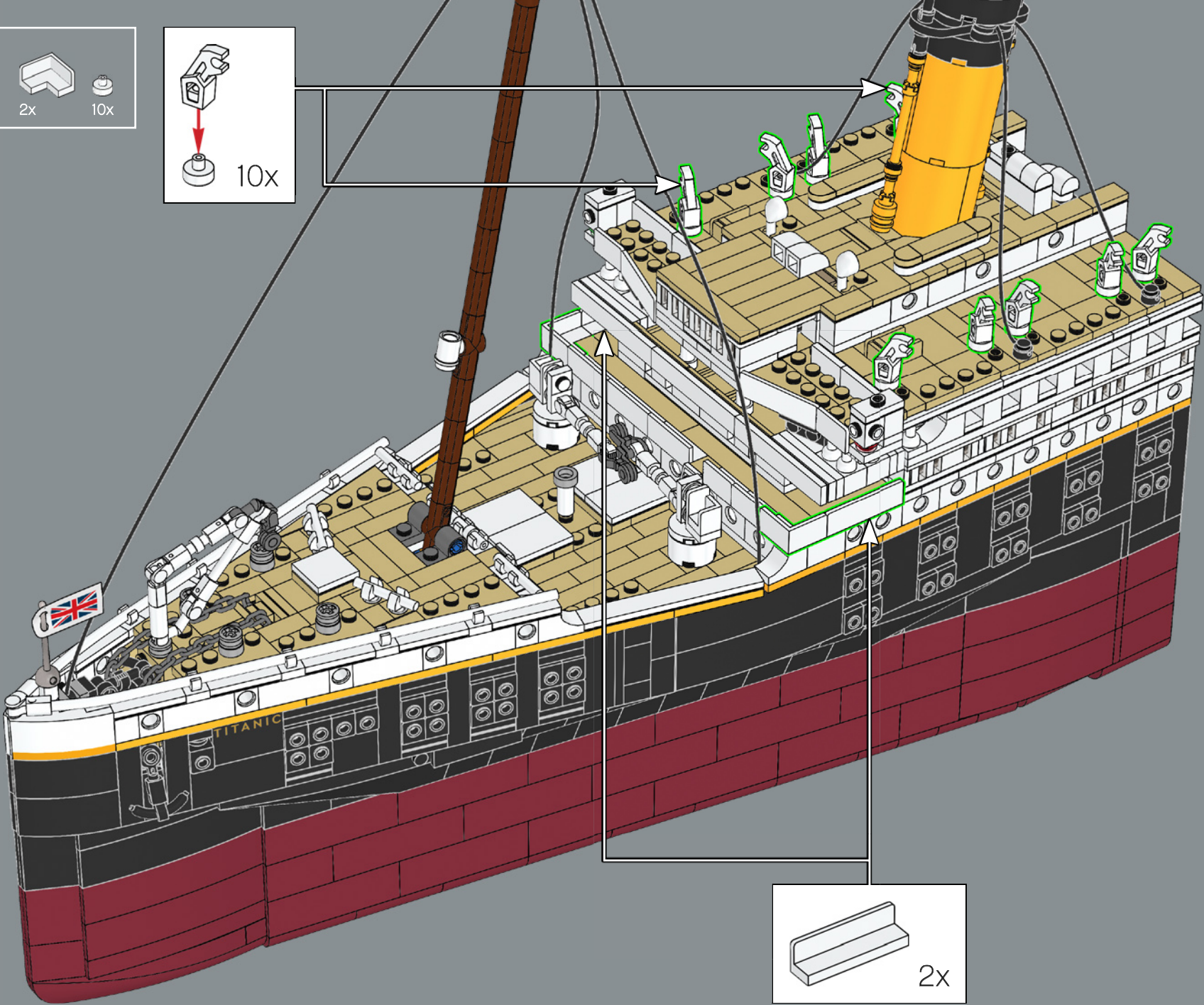
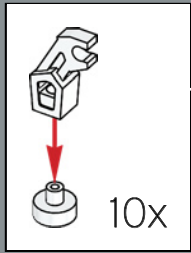



341

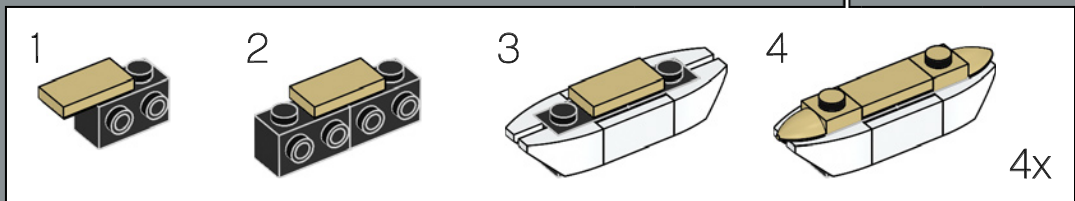
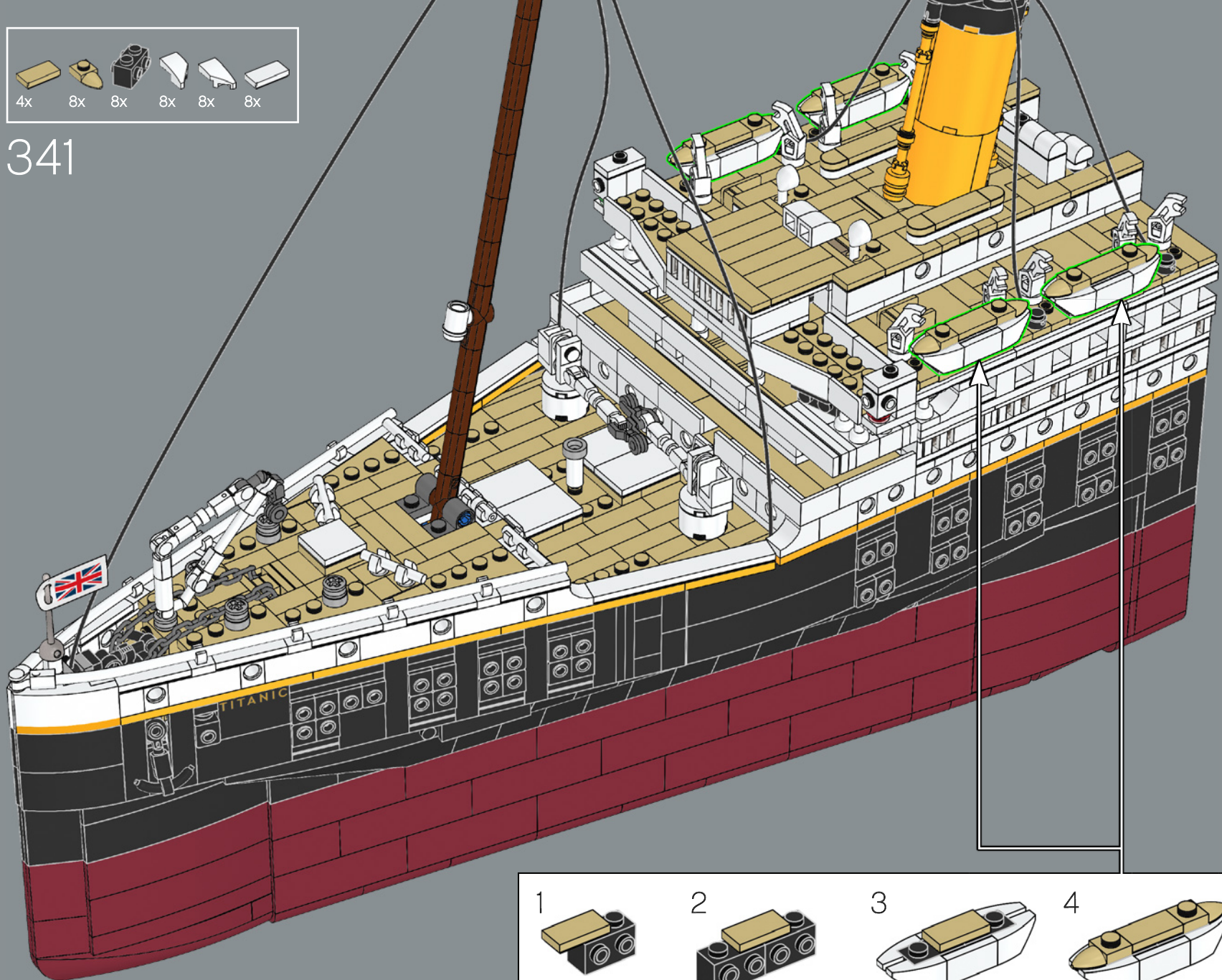

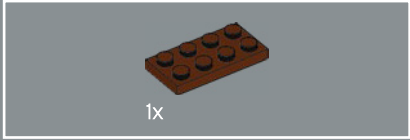
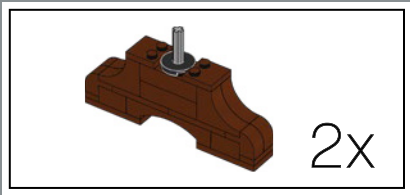

342

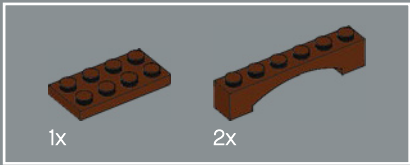
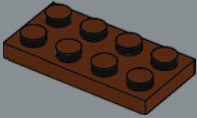

343

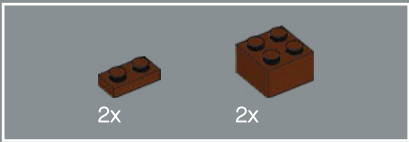
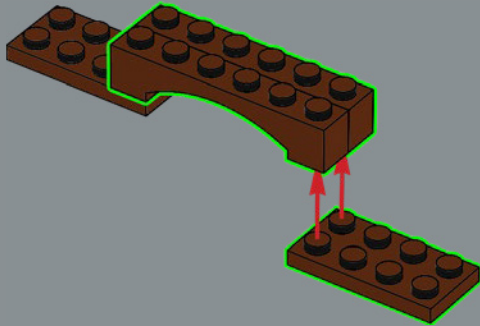

344

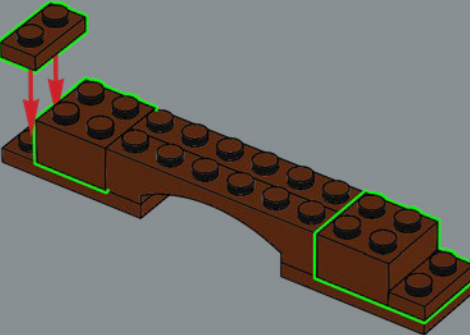

345

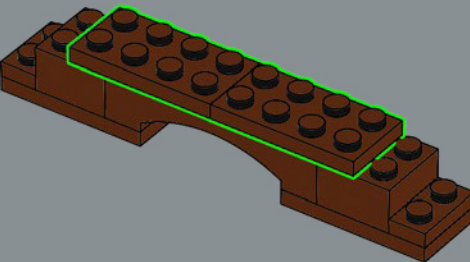

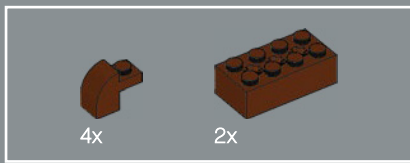

346

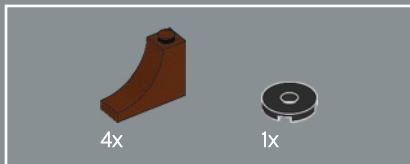
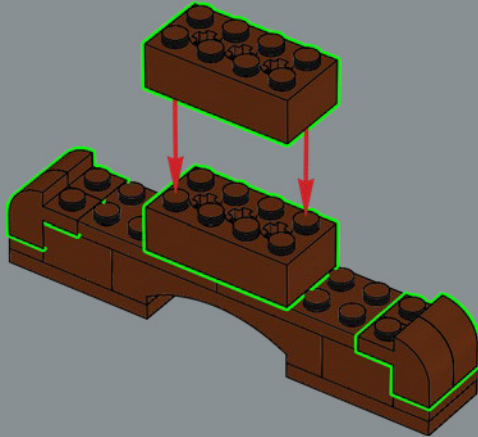

347

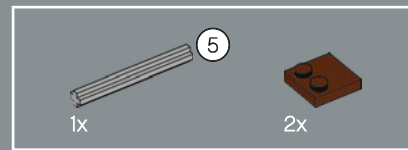
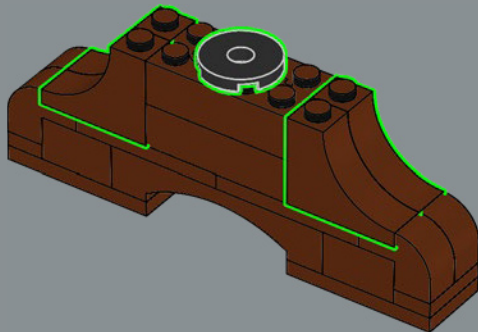

348

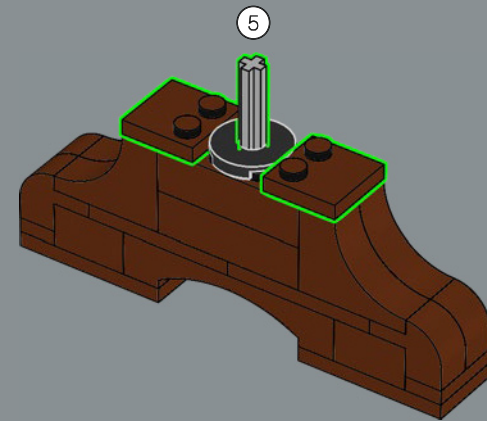
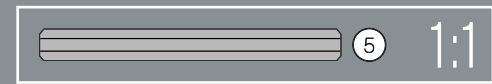

2x

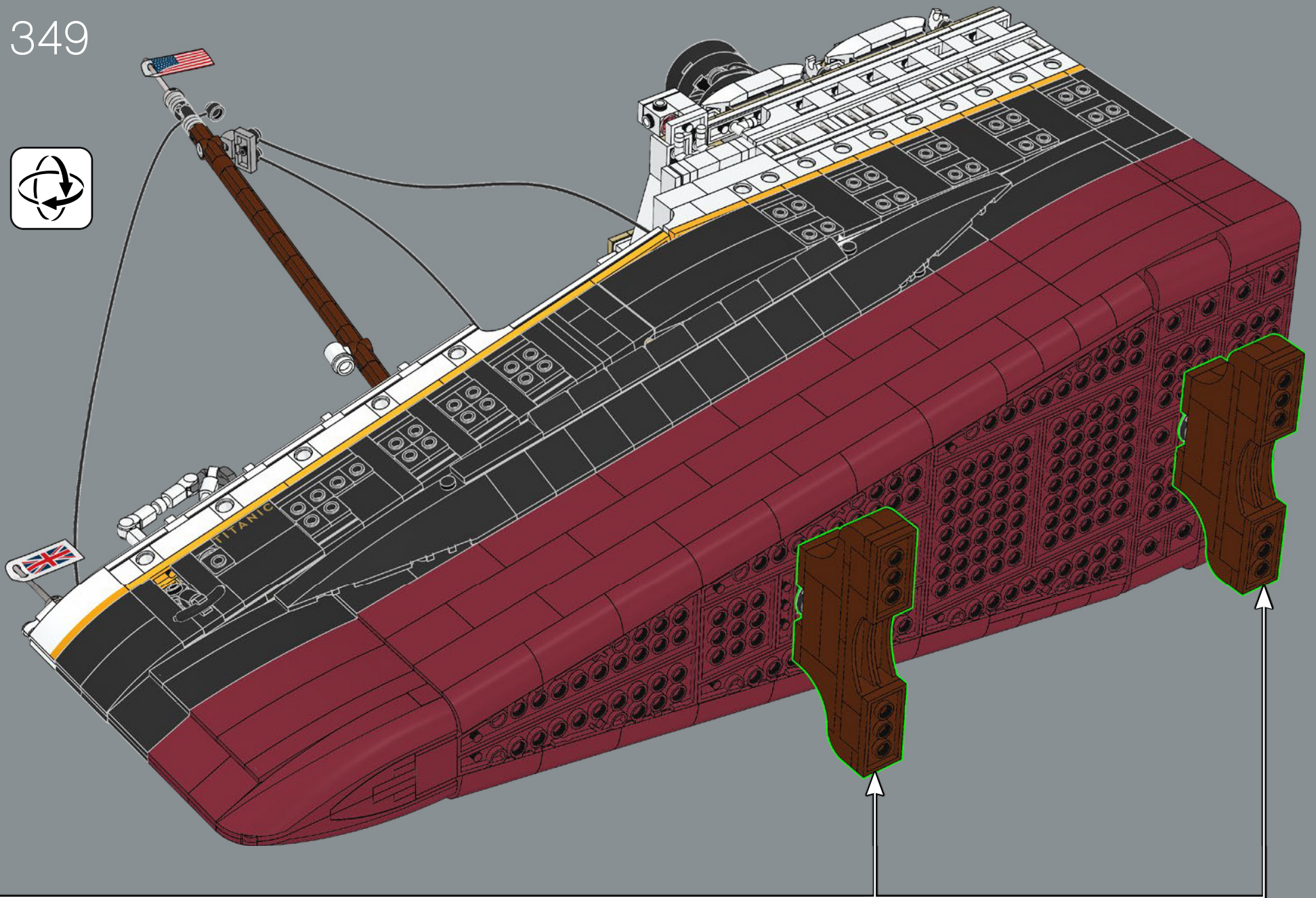

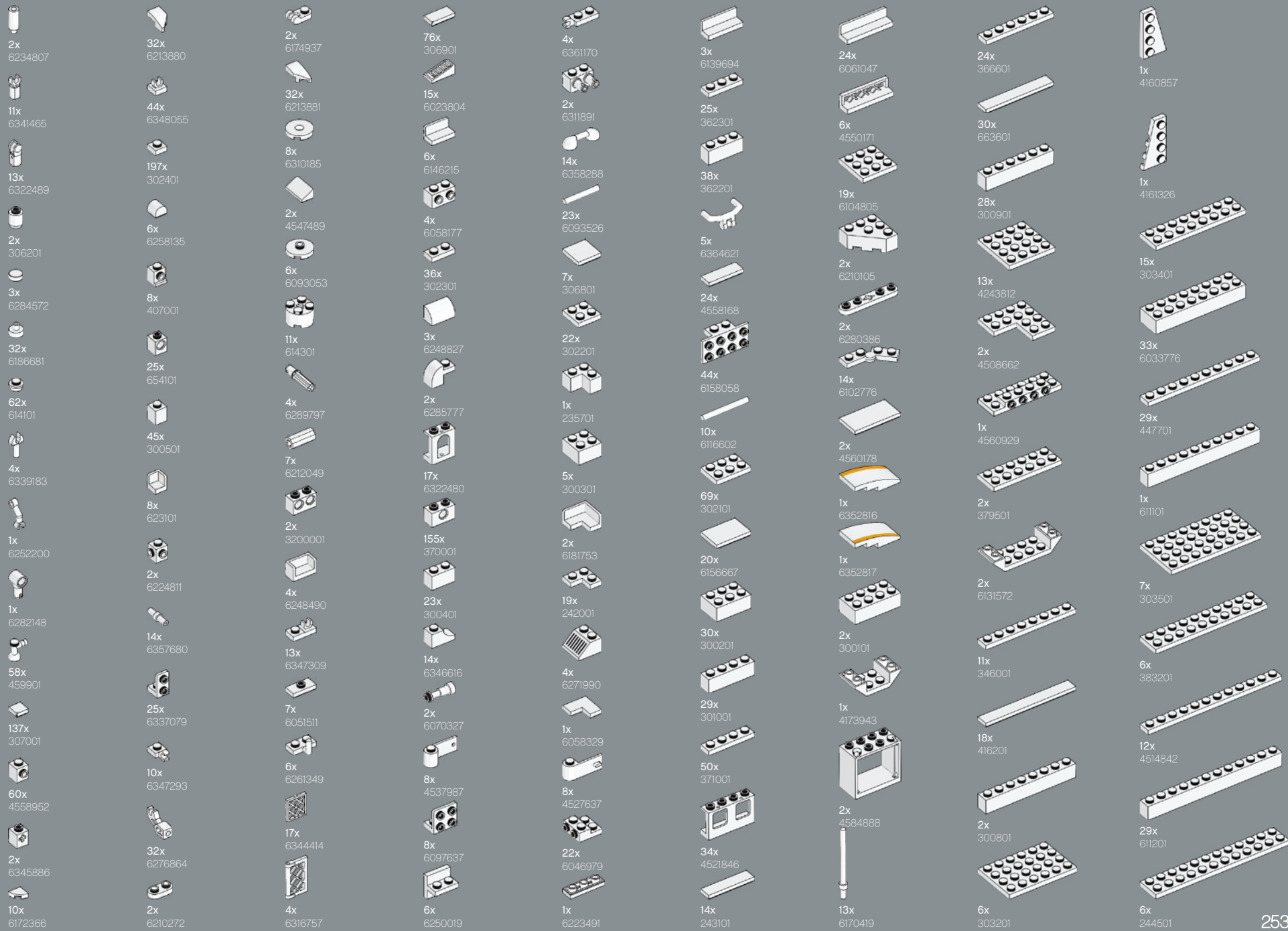

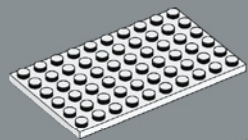

5x
4528341

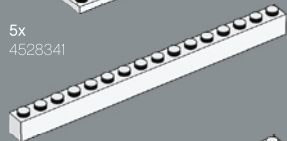

6x
246501

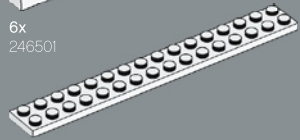

13x
4119227



2x
6365707

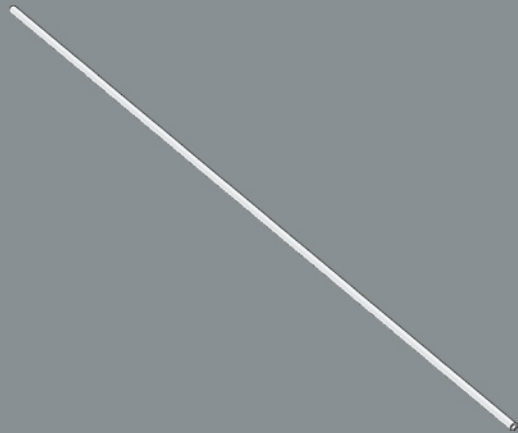

1x
6364683



1x
6370720



4x
6353196



44x
4118793



83x
6360078



2x
4113915



5x
4179771



54x
4125253



10x
4516055



20x
4159553



2x
4612603



2x
6357613



32x
4224793



4x
6355727



6x
6351413



14x
6352222



8x
6177890



8x
6177891



4x
4624086



4x
6232037



50x
4218749



41x
6092587



2x
6338180



4x
6148262



6x
4109995



6x
6146221



2x
6024495



13x
4205107



1x
6063943



2x
6294481



2x
6103001



153x
4114026



21x
4113917



20x
6034929



2x
4273526



2x
6214334



4x
6117975



4x
6249809



10x
6174925



5x
6253003



2x
6314477



2x
6358290



2x
6358289



1x
4565387



39x
4185177



44x
6221467



44x
4114084



47x
6173057



18x
4114077



16x
6265572



4x
6211975



96x
6131896



14x
4121921



2x
4624088



34x
6211966



2x
6318084



8x
4118790



9x
6175367



2x
4500453



5x
4666999



2x
4113233



12x
4550324



26x
6257600



2x
6195544



2x
6115031



2x
4208072



33x
4114309



53x
6122047



8x
6351905



2x
4112982



10x
4157277



3x
6331158



4x
4113993



5x
4181134



49x
4114324



11x
4544139



12x
4159774



2x
4114001



2x
4125217



2x
4166138



3x
4509897

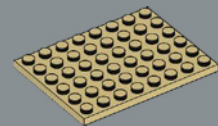

4x
6070501

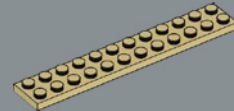

6x
6093864



6x
6284574



2x
306221



8x
654121



10x
6345429



1x
6210269



46x
4142865



2x
6168634



4x
6019155



1x
6265697



22x
302321



2x
245821



2x
6313831

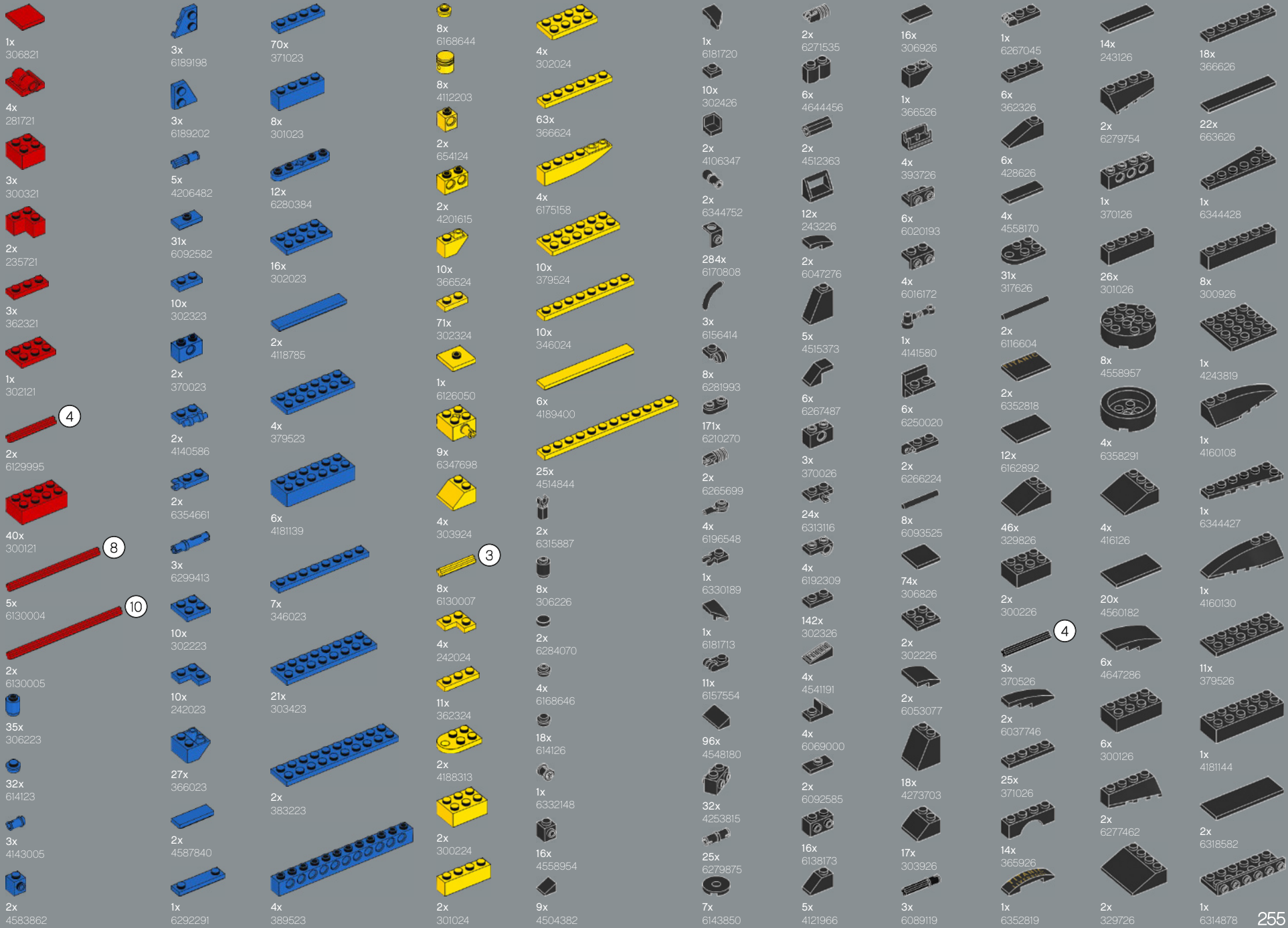

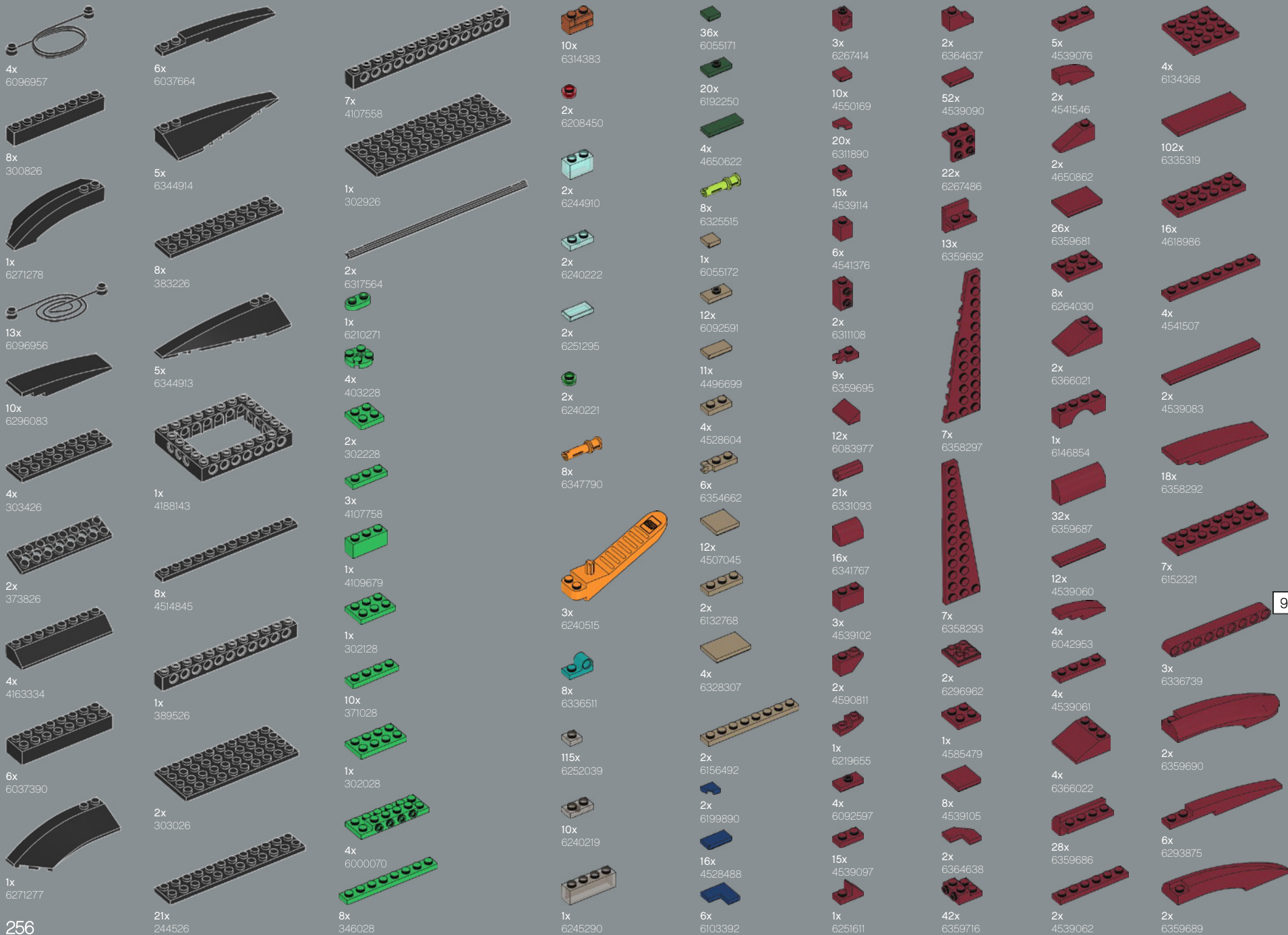

4x
6096957

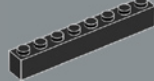

8x
300826



1x
6271278



13x
6096956



10x
6296083



4x
303426



2x
373826

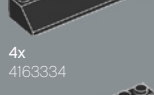

4x
4163334



6x
6037390



1x
6271277

6x
6037664

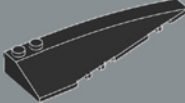

5x
6344914

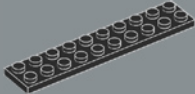

8x
383226

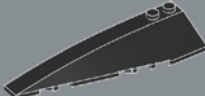

5x
6344913

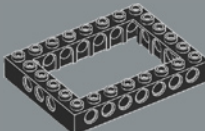

1x
4188143

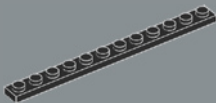

8x
4514845

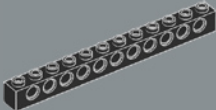

1x
389526

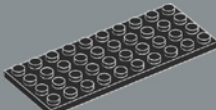

2x
303026

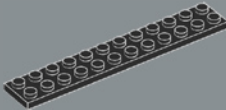

21x
244526

7x
4107558

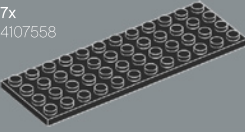

1x
302926



2x
6317564



1x
6210271



4x
403228



2x
302228



3x
4107758



1x
4109679



1x
302128



10x
371028



1x
302028



4x
6000070



8x
346028



10x
6314383



2x
6208450



2x
6244910



2x
6240222



2x
6251295



2x
6240221



8x
6347790



3x
6240515



8x
6336511



115x
6252039



10x
6240219



1x
6245290



1x
6245290



1x
6245290



36x
6055171



20x
6192250



4x
4650622



8x
6325515



1x
6055172



12x
6092591



11x
4496699



4x
4528604



6x
6354662



12x
4507045



2x
6132768



4x
6328307



2x
6156492



2x
6199890



16x
4528488



3x
6267414



10x
4550169



20x
6311890



15x
4539114



6x
4541376



2x
6311108



9x
6359695



12x
6083977



21x
6331093



16x
6341767



3x
4539102



2x
4590811



1x
6219655



4x
6092597



15x
4539097



2x
6364637



52x
4539090



22x
6267486



13x
6359692



7x
6358297



7x
6358293



2x
6296962



1x
4585479



8x
4539105



2x
6364638



42x
6359716



5x
4539076



2x
4541546



2x
4650862



26x
6359681



8x
6264030



2x
6366021



1x
6146854



32x
6359687



12x
4539060



4x
6042953



4x
4539061



4x
6366022



8x
4539105



2x
6364638



2x
4539062



4x
6134368



102x
6335319

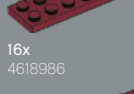

16x
4618986

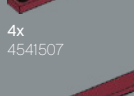

4x
4541507

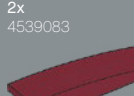

2x
4539083



18x
6358292

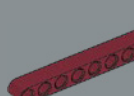

7x
6152321

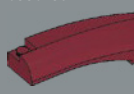

3x
6336739

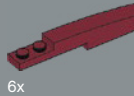

2x
6359690

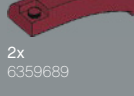

9

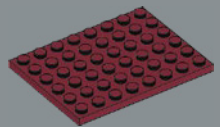

11x
6028115

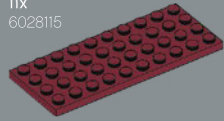

8x
6186106



8x
6245265



16x
6134252



8x
6223719



16x
6331261



6x
6073040



6x
6028736



91x
6097503



16x
6358295



16x
6020073



4x
6359223



12x
6020074



9x
6192205

6x
4211183



19x
4216581



1x
6170813



2x
6149677



12x
4221744



26x
4211288



46x
4225469



4x
6325717



29x
4531751



2x
4211222



1x
4211252



14x
6365885



105x
4211150



24x
6335567

1x
4211151



10x
6365884



24x
4645103



39x
6236915



20x
6196221



30x
4211210



10x
6365883



5x
6333110



6x
4211220



20x
4211152



24x
6133833



9x
6172636



30x
4211186



1x
4221590

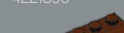

18x
4211193



12x
4655611



1x
4216615



6x
6313736



2x
4211211



2x
4222627



1x
6338230

88x
4211412



23x
6258831



7x
6171165



1x
4211483



3x
4558953



12x
4211399



2x
6225242



2x
6345639



8x
6335378



8x
4211375



8x
6227897



4x
4568637



2x
6352979



2x
6352983



1x
6352986



1x
6352997



1x
6353001



155x
4550325



2x
6372076



4x
6327412



9x
6338165



2x
4211564



20x
4211398



8x
4211414



8x
4211440



10x
6206249



1x
6326078



8x
6146300



8x
4211363



4x
4211494



2x
4211614



4x
6117967



6x
4654580



8x
4211609



4x
6337268



4x
6078211



4x
6198932



4x
4667578



4x
4211461



4x
4211632



4x
6321743



1x
4208988



1x
4209006



8x
4211397



46x
6212077



6x
6007894



6x
4234535



4x
4211815



4x
6078212



8x
6195471



1x
6346487



4x
6326483



1x
6304930



15x
6211969



8x
4211419



11x
4211773



30x
4211396



1x
4211386



9x
4211394



1x
4211441



2x
4211445



26x
4211636



8x
6230229



2x
4211361



2x
4211395



8x
4211385



6x
4211639



4x
6256117



8x
6105964



6x
4211393



16x
4211438



2x
4612621



2x
4211837



2x
4527174



4x
6015349



35x
4211452



13x
4211795



4x
6225219



4x
4211425



2x
4211442





2x
4211481

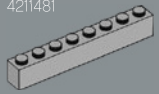

2x
4211392



4x
4211404

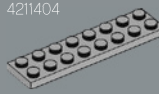

3x
4211406

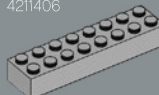

33x
6037399



37x
4211474



1x
4251149



2x
4211374

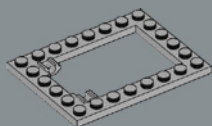

1x
6152230

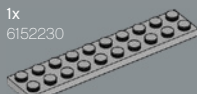

6x
4211462

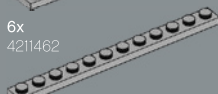

10x
4514846

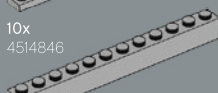

41x
4211522



8x
4211402



3x
4211360



10x
4166618

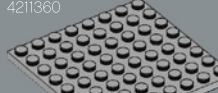

2x
4211401



4x
4682161



1x
6336970



11x
4211081



3x
6012451



4x
4211044



2x
6350724



1x
6318697



8x
4278274



8x
6278986



21x
4211042



8x
6135014



8x
4516546



2x
6019987



4x
6092572



42x
4210631



7x
6338160



1x
4211093



28x
4218696



1x
6167281



4x
6133119



39x
4211043



2x
6106025



8x
4211001



2x
6185675



2x
4219725



2x
4528323



10x
6102774



4x
4211065



8x
6170420

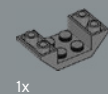

1x
4211076



1x
4210917

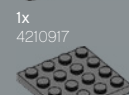

2x
4243831



7x
4211002



12x
4595710



26x
4211115



2x
6141856



4x
4211067



21x
6000970



1x
6287847

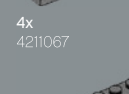

2x
4529247



8x
6376752



94x
4523159



22x
6146054



3x
6322046



4x
6287672



4x
6249815



1x
6324205



1x
6336665



5x
6175943



2x
6301315



4x
6222063



2x
6258887



Customer Service

Kundenservice

Service Consommateurs

Servicio Al Consumidor

LEGO.com/service or dial



00800 5346 5555 :



1-800-422-5346 :





FEEDBACK AND WIN



FEEDBACK AND WIN

Your feedback will help shape the future development of this product series.

Please visit:

FEEDBACK UND GEWINNEN

Dein Feedback trägt zur Weiterentwicklung dieser Produktreihe bei.

Geh auf:

COMMENTEZ ET GAGNEZ

Vos commentaires nous aideront à concevoir les futurs produits de cette gamme.

Rendez-vous sur :

COMENTA Y GANA

Tu opinión nos ayudará a dar forma al desarrollo de esta serie de productos en el futuro.

Visita:

反馈有奖

您的反馈将有助于我们在今后改进本系列产品。

请访问：

[LEGO.com/productfeedback](https://www.lego.com/productfeedback)

By completing, you will automatically enter a drawing to win a LEGO® set.

Terms & Conditions apply.

Durch Ausfüllen nimmst du automatisch an der Verlosung eines LEGO® Preises teil.

Es gelten die Teilnahmebedingungen.

En envoyant vos commentaires, vous serez automatiquement inscrit(e) à un tirage au sort qui vous permettra de remporter un prix LEGO®.

Offre soumise à conditions.

Al contestar, participarás automáticamente en el sorteo y podrás ganar un set LEGO®.

Sujeto a Términos y Condiciones.

完成我们的反馈调查，即可自动进入抽奖环节，赢取乐高®套装。

适用《条款和条件》。

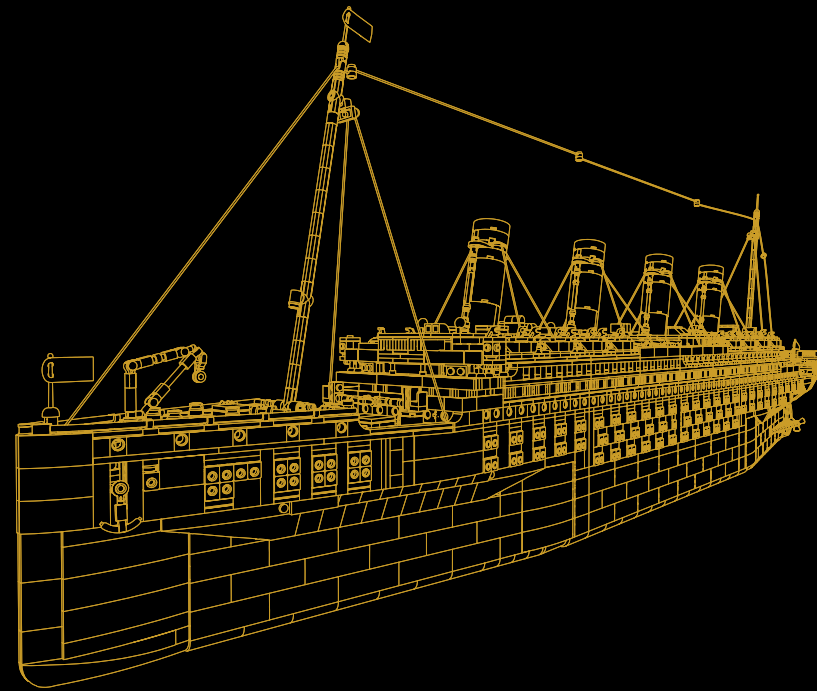

LEGO and the LEGO logo are trademarks of the LEGO Group. ©2021 The LEGO Group.