

TNA

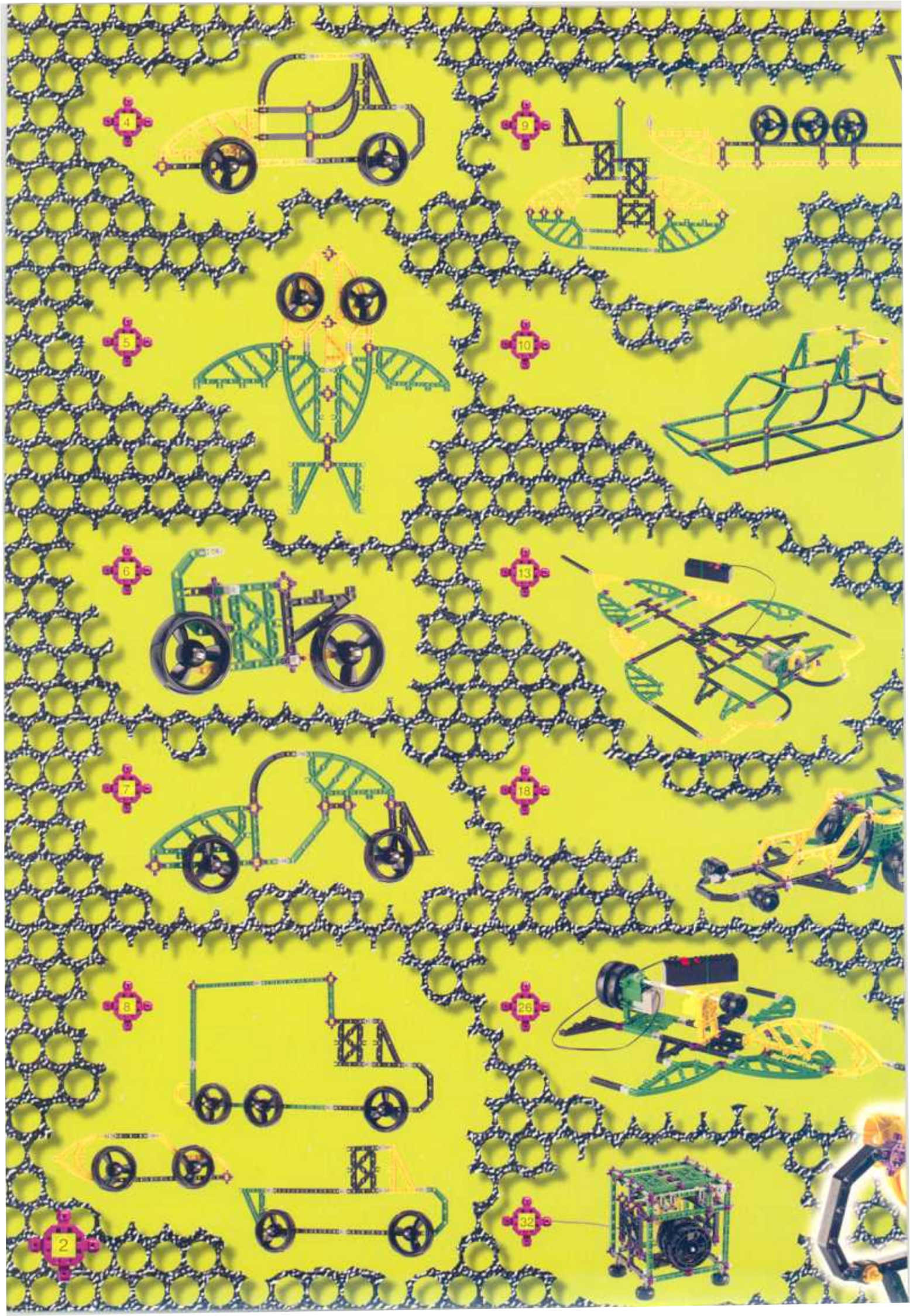

3591





43



122



44

134



136



80

138



99

140

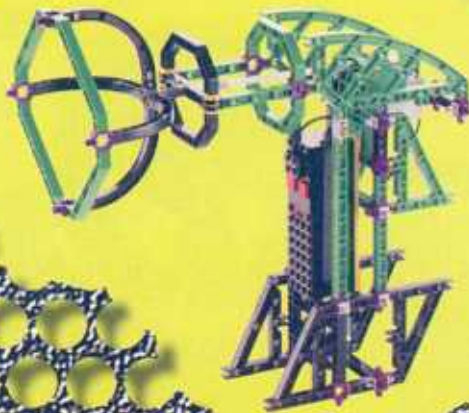

3



1

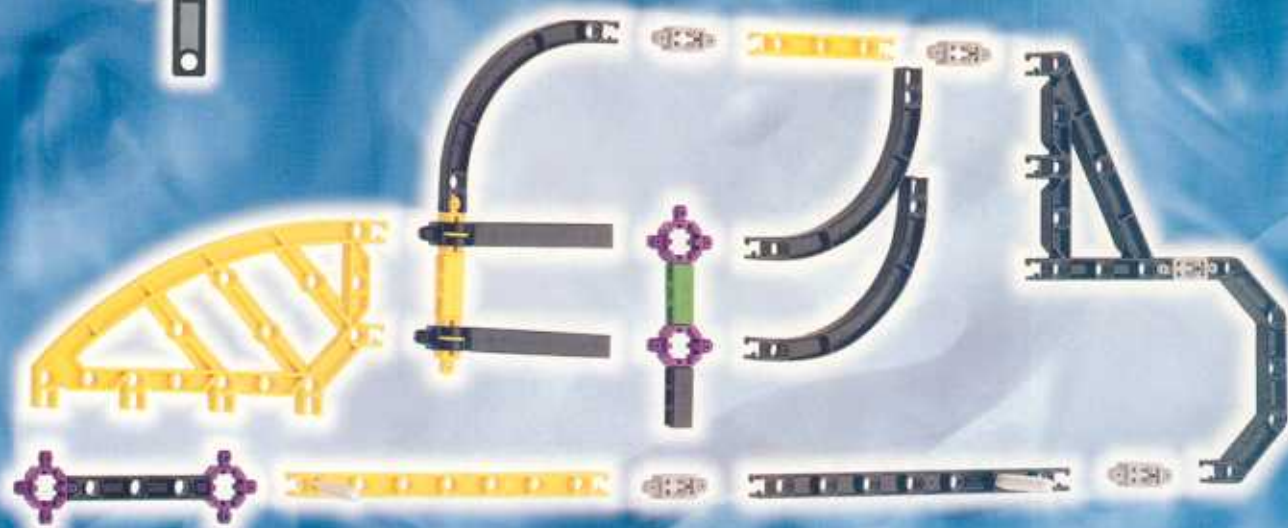

2

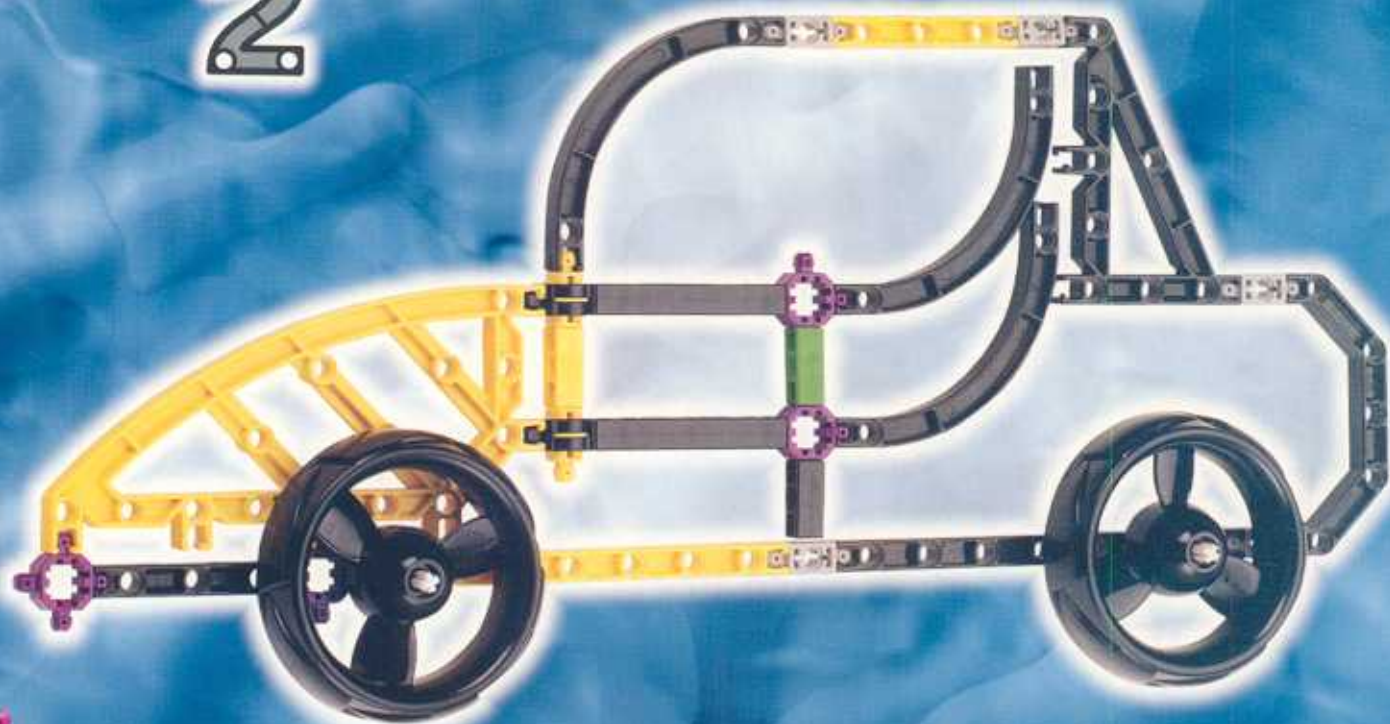

1

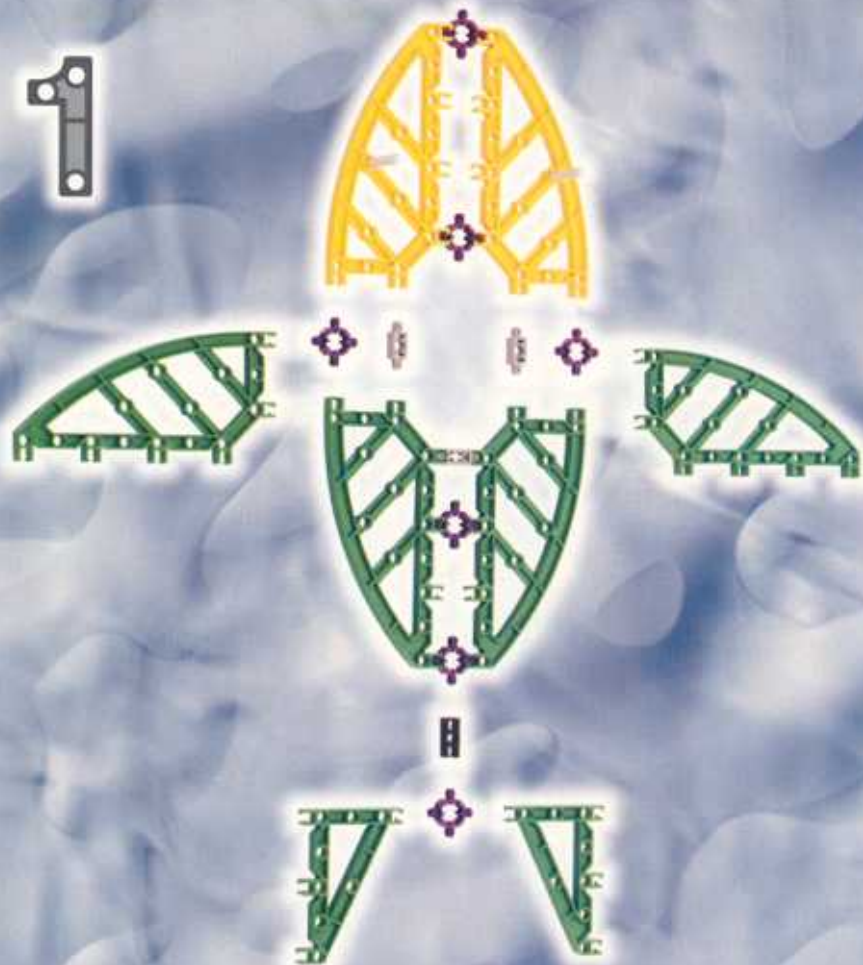

2

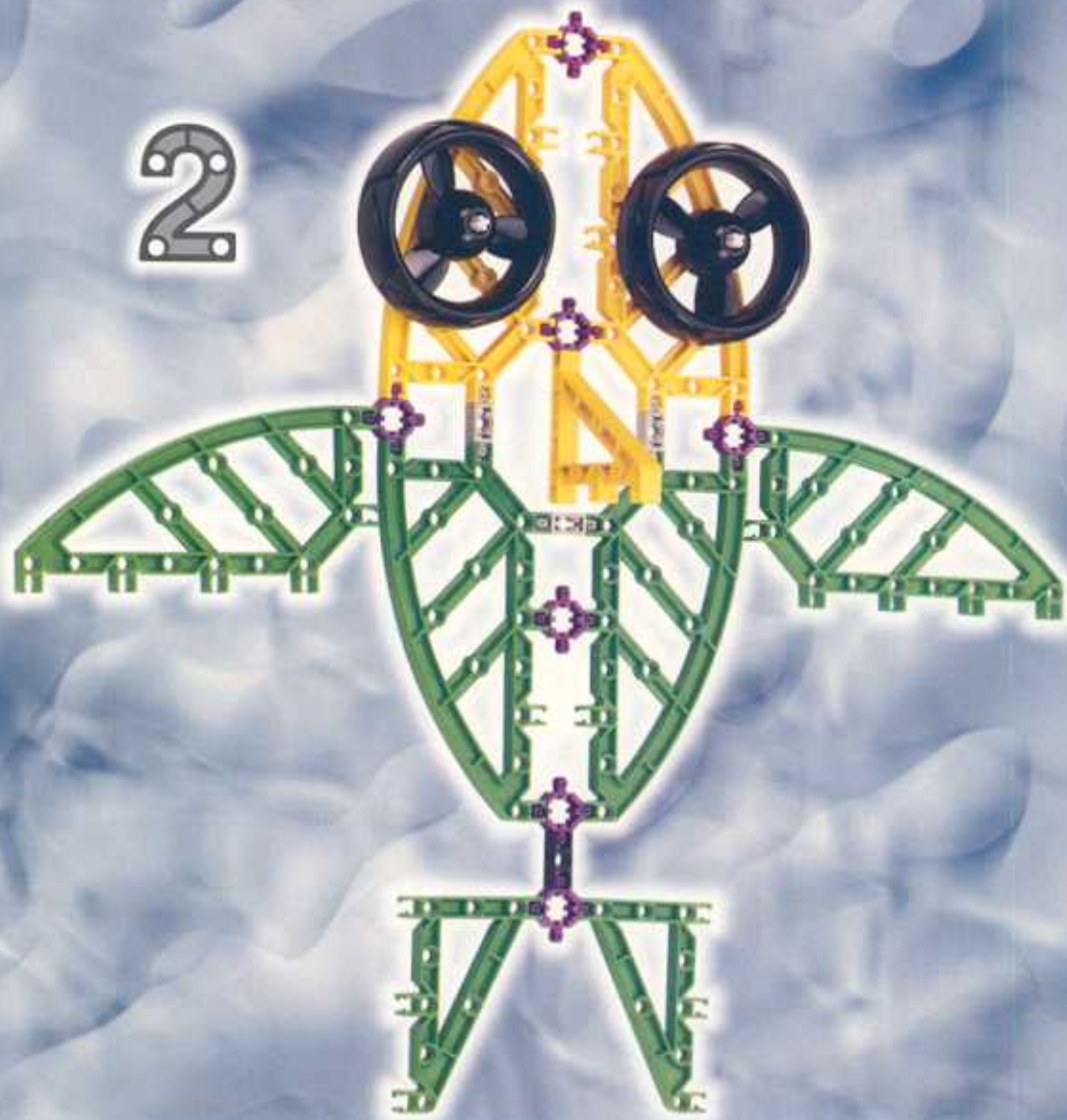

1

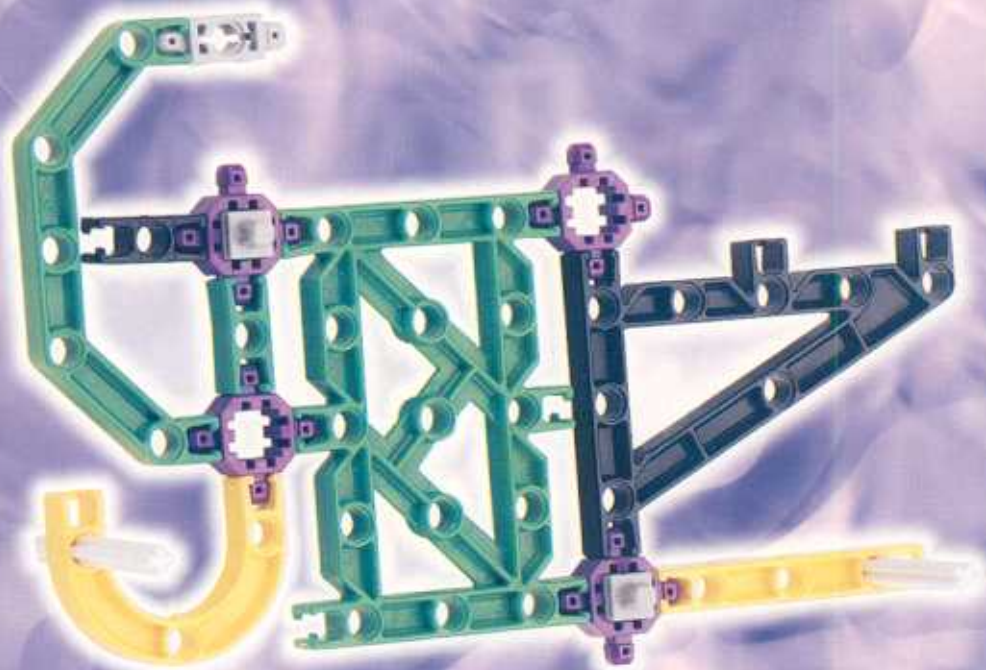

2

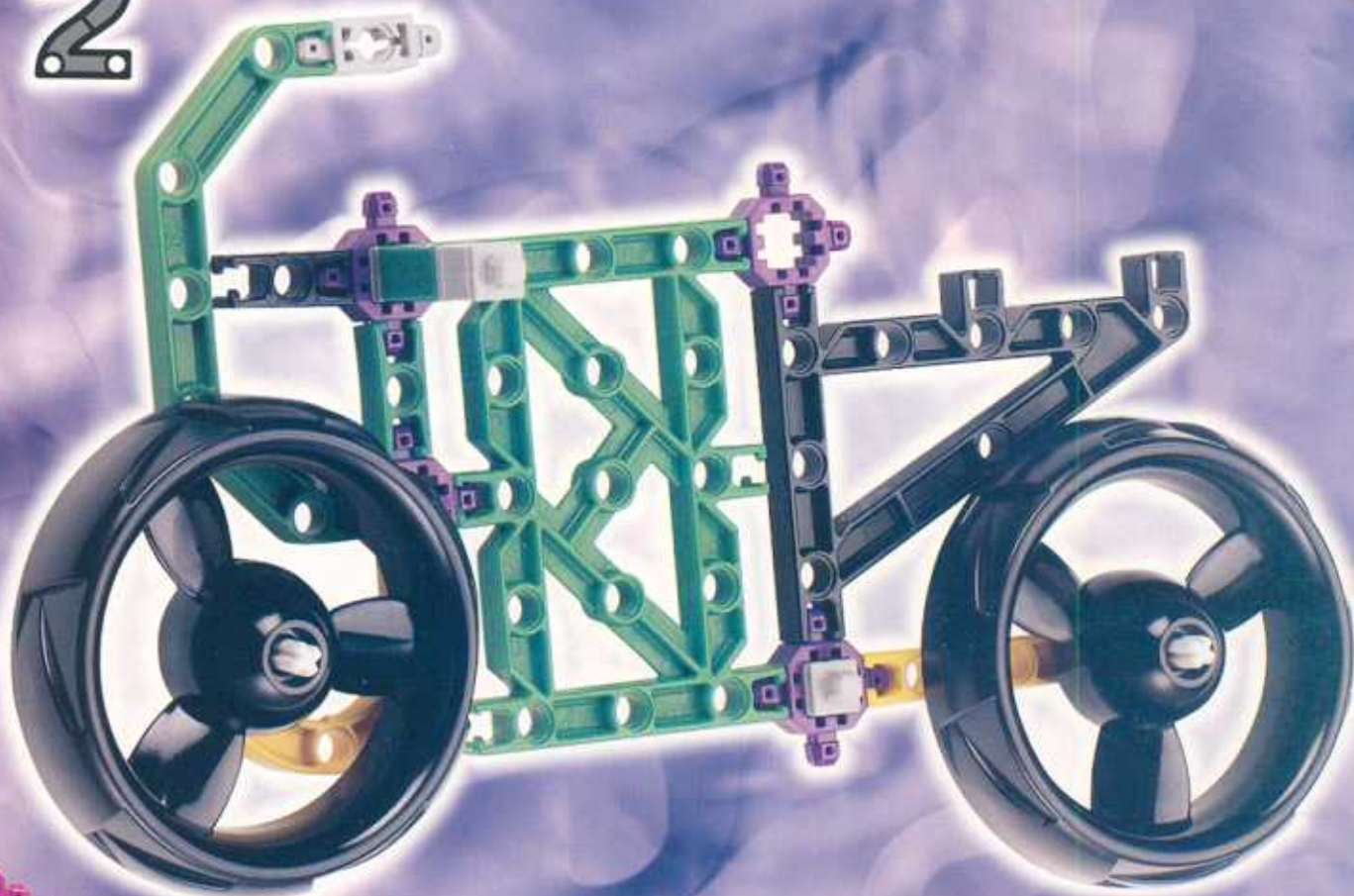

1

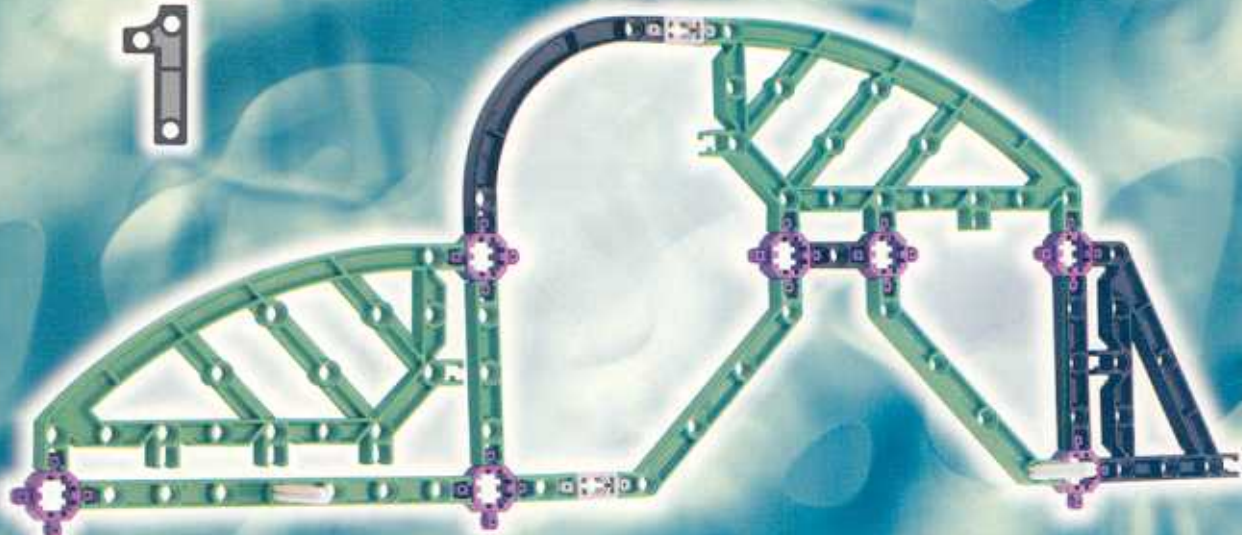

2

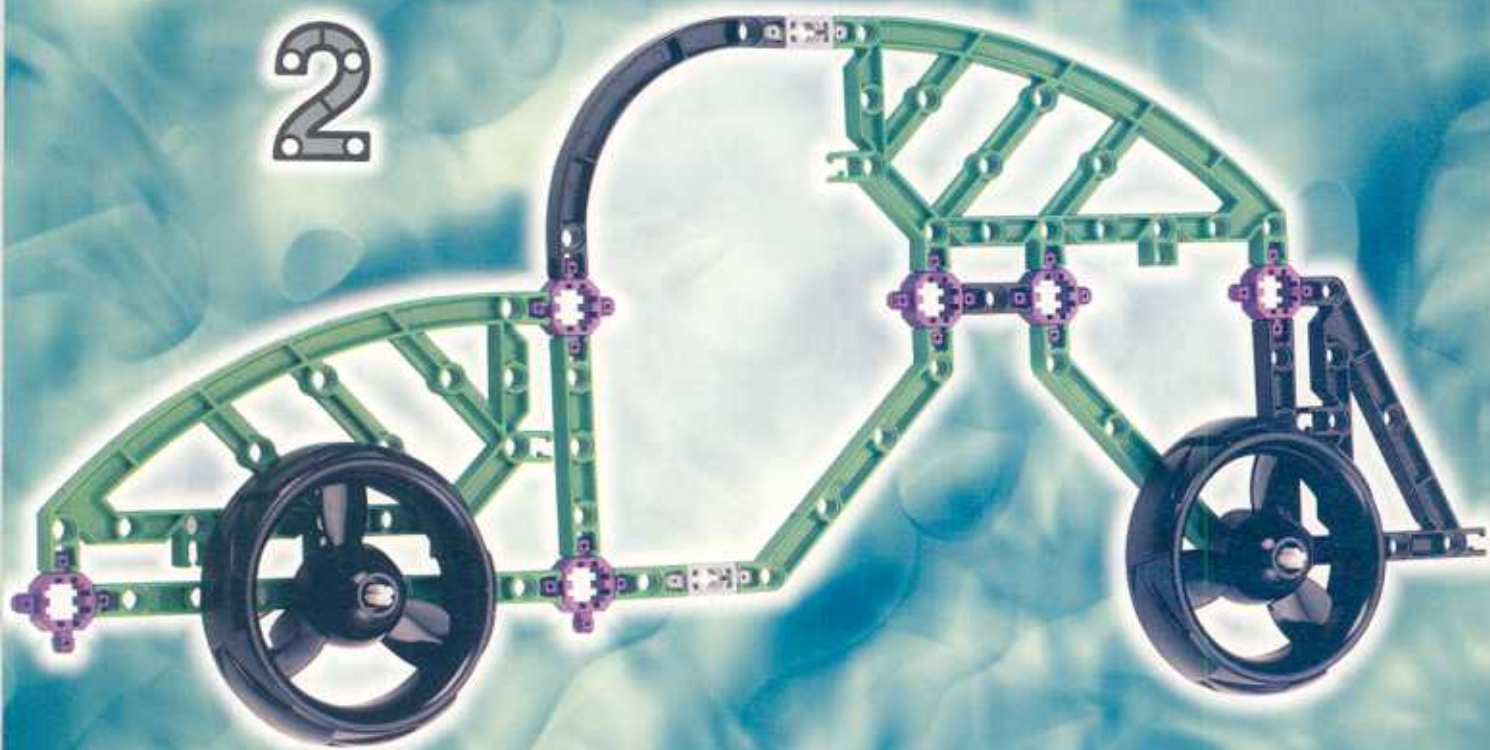

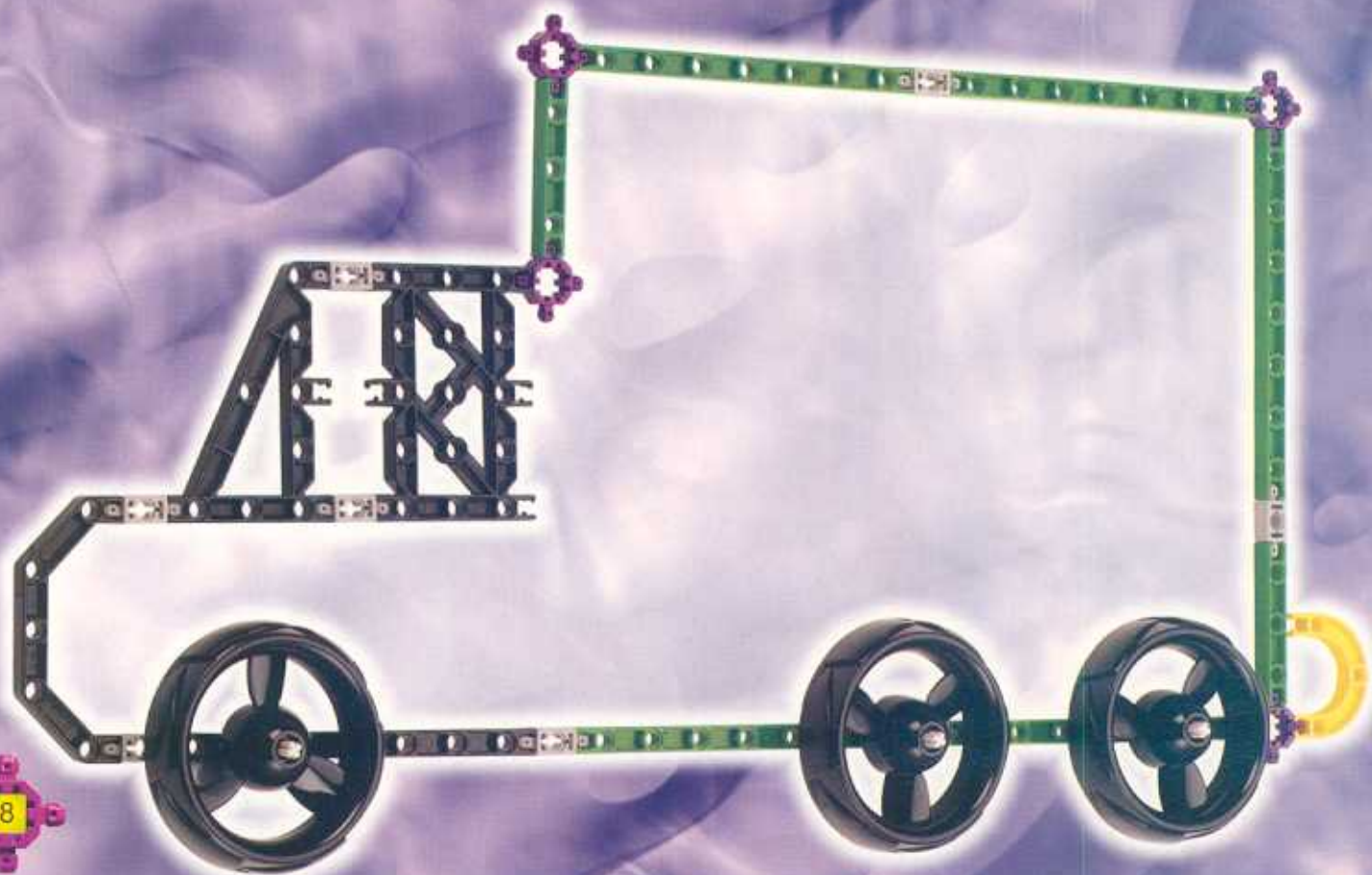
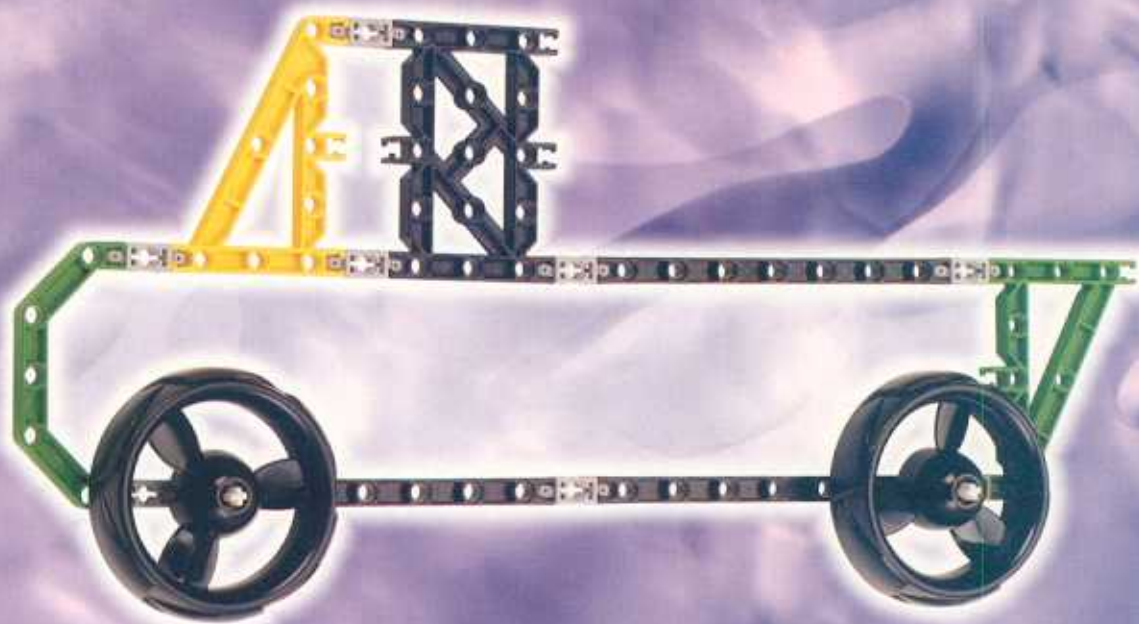
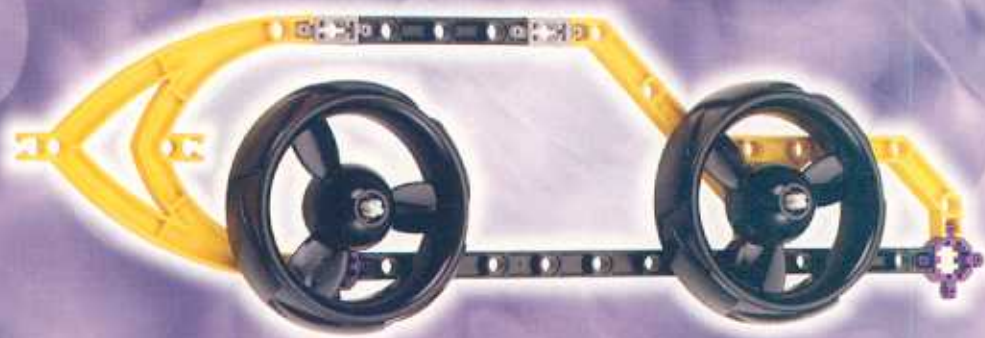

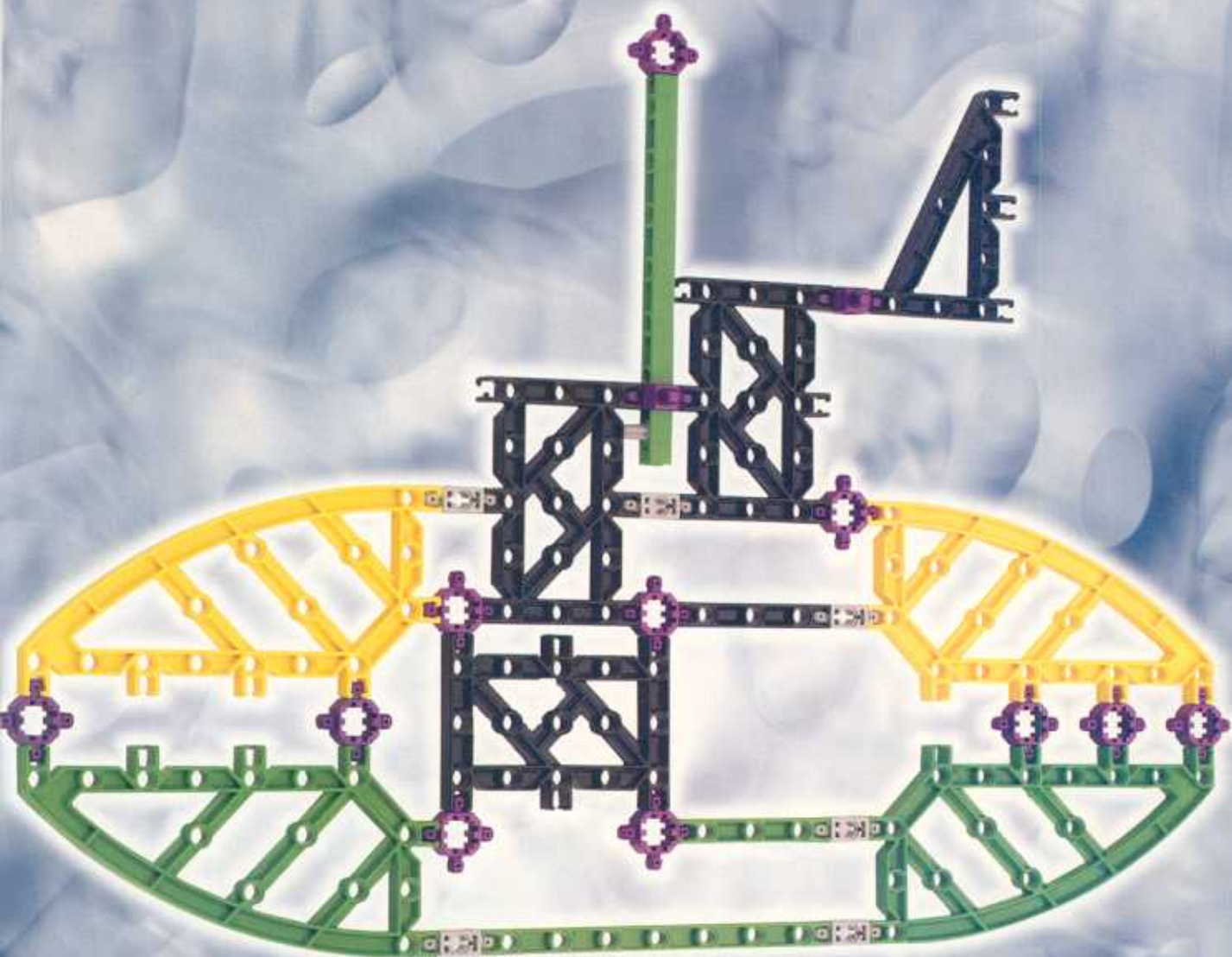
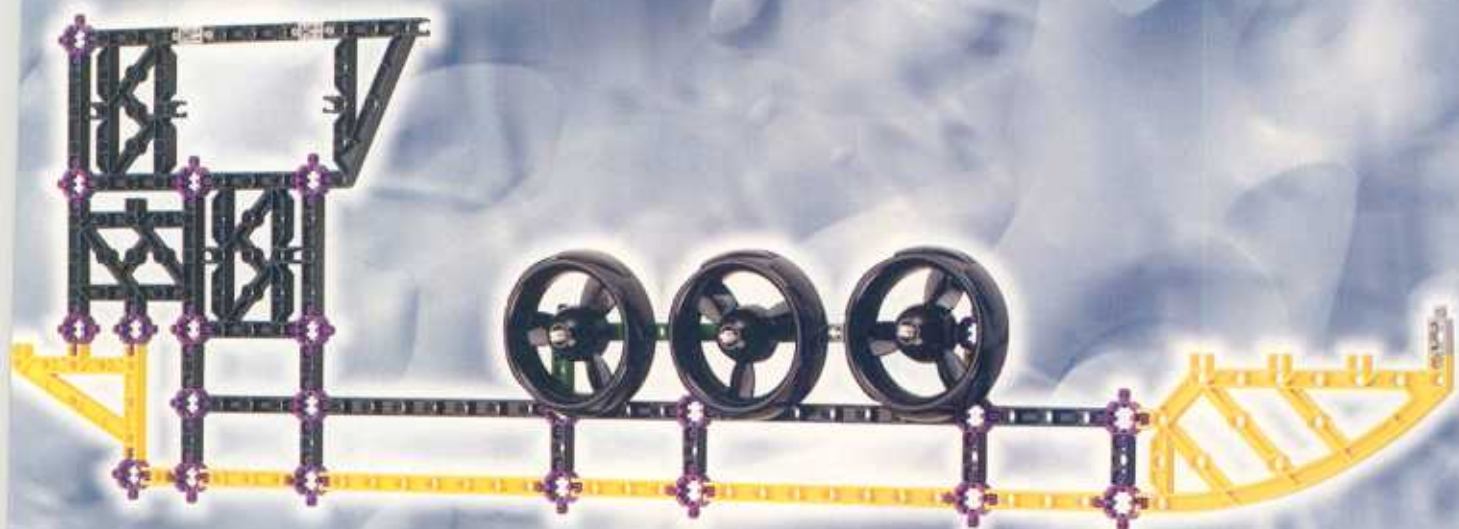



2

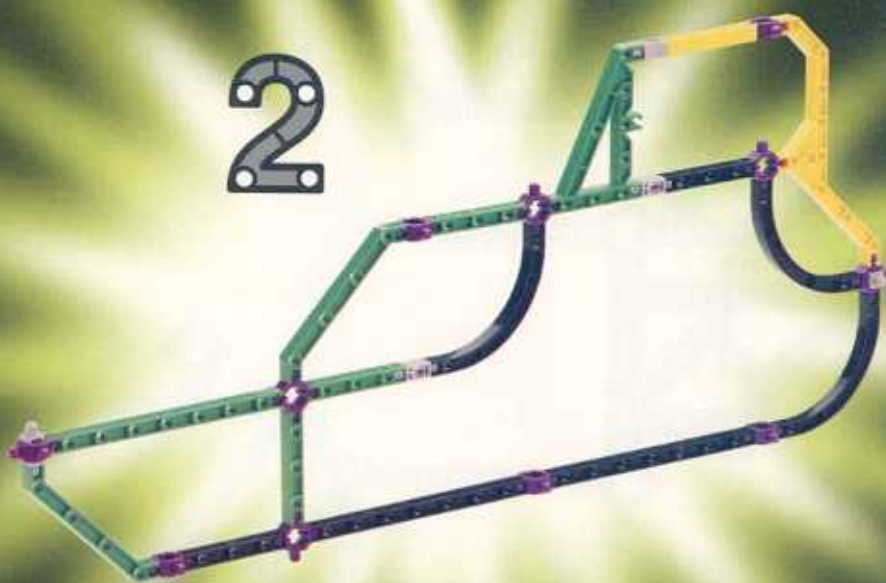

3

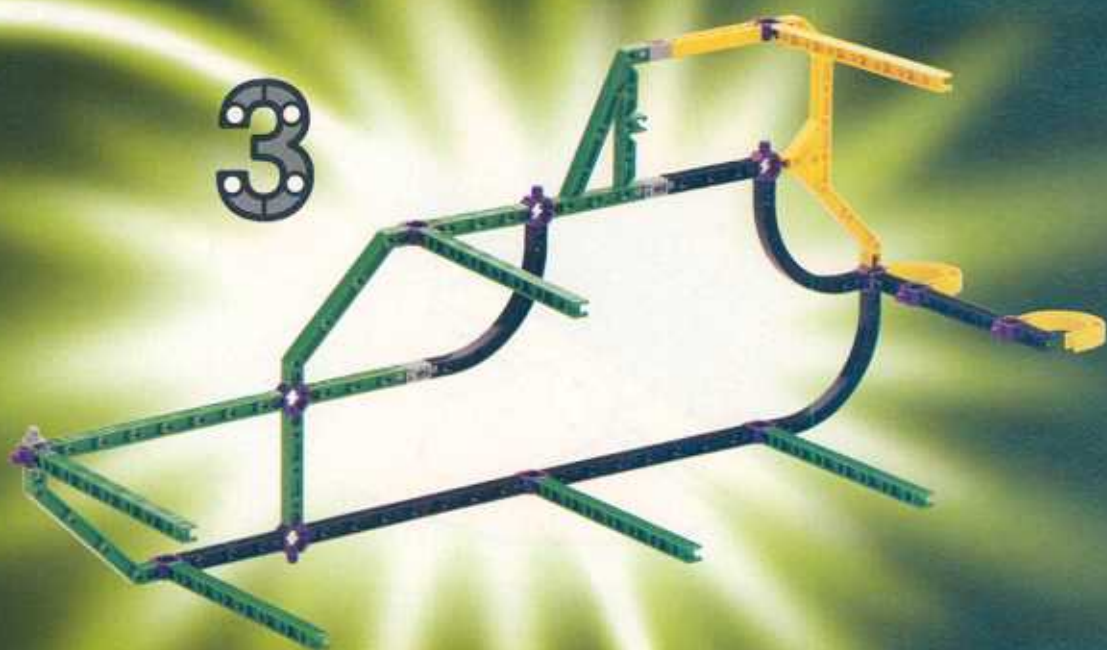

4

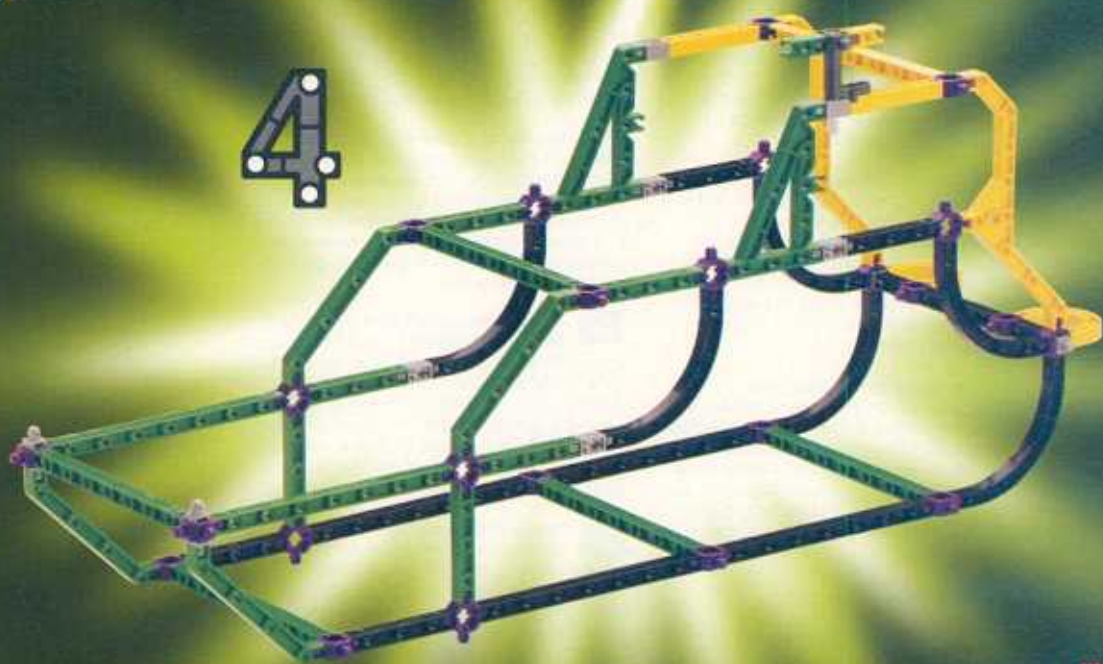

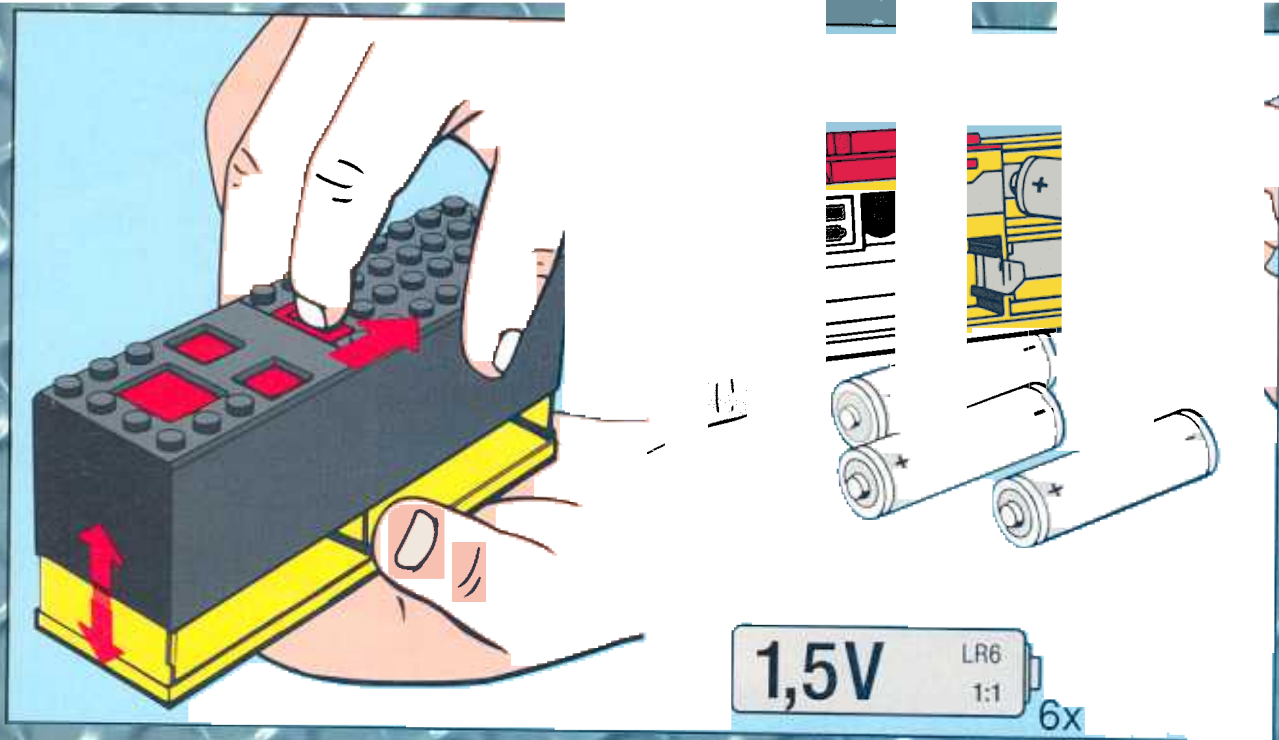

UK **Instructions for use of battery box**
 Never mix different types of batteries or old and new batteries in one battery box. Always remove the batteries from the battery box for long-term storage or if they have reached the end of their life. Liquid leaking from dead batteries will damage the battery box. Rechargeable batteries can be used but power may be reduced. Do not recharge the batteries in the battery box.

D **Bedienungshinweise für Batteriekästen**
 Benutze niemals verschiedene Batterietypen oder alte und neue Batterien gemeinsam in einem Batteriekasten. Nimm aufgebrauchte Batterien gleich aus dem Batteriekasten. Lagere den Batteriekasten für längere Zeit stets ohne Batterien. Austretende Flüssigkeit aus alten Batterien kann den Batteriekasten beschädigen. Du kannst wiederaufladbare Batterien benutzen. Aber lade sie nicht im Batteriekasten auf. Entsorge verbrauchte und alte Batterien immer über Sammelstellen. Sie gehören nicht in den Hausmüll!

F **Instructions pour l'utilisation du boîtier-piles**
 Ne mélangez jamais différents types de piles, ou des anciennes piles avec des neuves. Pensez à enlever les piles du boîtier lorsque vous ne vous en servez pas, et ne les gardez pas trop longtemps, car le liquide provenant de piles usagées peut endommager le boîtier. Vous pouvez utiliser des piles rechargeables, mais ne les rechargez pas dans le boîtier-piles.

I **Istruzioni per l'uso del portapile**
 Non utilizzare pile vecchie e nuove nello stesso portapile. Togliere sempre le pile se scariche o se non devono essere utilizzate per lungo tempo. Il liquido che fuoriesce dalle pile scariche danneggia il portapile. E' possibile utilizzare pile ricaricabili. Non ricaricare le pile nel portapile.

NL **Zo gebruikt u de batterijhouder**
 Gebruikt u nooit verschillende type batterijen of nieuwe en oude batterijen bij elkaar in een batterijhouder. Als u de batterijhouder langere tijd niet gebruikt, verwijdert u dan de batterijen. Dit geldt ook voor batterijen die leeg zijn. Batterijen die leeg zijn of die lang in de batterijhouder zitten kunnen gaan lekken. Dit veroorzaakt onherstelbare schade en valt niet onder garantie. U kunt oplaadbare batterijen gebruiken. Laad nooit batterijen op in de batterijhouder.

E **Instrucciones para el uso del porta-pilas**
 Dentro de una misma caja porta-pilas no mezclar nunca distintos tipos de pilas ni tampoco las nuevas con las ya usadas. Sacar siempre las pilas de la caja porta-pilas cuando no vayan a utilizarse por un tiempo y cambiarlas igualmente cuando estén muy usadas, ya que el líquido que desprenden puede dañar las conexiones de la caja porta-pilas. Pueden utilizarse pilas recargables, si bien no deben recargarse dentro de la caja porta-pilas.

DK **Batteriinformation**
 Brug aldrig forskellige typer batterier sammen, eller nye og gamle batterier i samme batteriboks. Tag altid batterierne ud af batteriboksen, hvis du ikke skal bruge den i længere tid, eller hvis batterierne er brugt op. Væske fra batterierne kan ødelægge batteriboksen. Man kan anvende genopladelige batterier. Genoplad aldrig batterierne i batteriboksen.

FIN **Paristokotelon käyttöohje**
 Erityyppisiä tai uusia ja vanhoja paristoja ei pitäisi koskaan käyttää samanaikaisesti. Poistakaa paristot aina paristokotelosta mikäli ne ovat loppuunkäytetyt tai mikäli ette käytä paristokoteloita pitkään aikaan. Nestevuodot loppuunkäytetyistä paristoista vahingoittavat paristokoteloita. Voitte käyttää myös akkuja. Älkää kuitenkaan ladatko akkuja paristokotelossa.

S **Instruktioner till batteriboxen**
 Blanda inte olika typer av batterier och inte heller nya och gamla batterier i samma batteribox. Ta ut batterierna ur boxen om du inte skall använda den på länge, eller om batterierna är slut. Läckande vätska från gamla batterier skadar batteriboxen. Laddningsbara batterier kan användas. Ladda inte upp batterierna i batteriboxen.

P **Instruções para utilização da Caixa de Pilhas**
 Não misturar nunca pilhas de tipos diferentes ou pilhas novas e velhas na mesma caixa de pilhas. Retirar sempre as pilhas da caixa no caso de armazenagem prolongada ou se elas já estiverem gastas. O líquido vertido pelas pilhas gastas danificará a caixa de pilhas. Podem ser utilizadas pilhas recarregáveis. Não recarregue as pilhas na caixa.

H **Utasítások az elemtartó használatához**
 Soha ne használj egyszerre különböző fajta elemeket vagy használt és új elemeket egy elemtartóban. Ha sokáig nem használod az elemeket vagy ha már lemerültek, vedd ki őket az elemtartóból. Az elhasználotott elemekből kiáramló folyadék tönkretelheti az elemtartót. Feltölthető elemeket természetesen használhatsz, de élettartamuk rövidebb lehet. Soha ne töltés fel az elemeket a elemtartóban.

GR **Οδηγίες χρήσεως του Φορτίου μπ*τ*ρι*ς**
 Ποτέ μην μ*τ*ρ*ν*ν*ν*ν*τε δ*ο*φορετ* Φορτίο τύπου μπ*τ*ρ*· Ψν ή νέες με π*λ*· ες μπ*τ*ρι*ς στο δ*ο*φορτίο. Ότ*ν τ*ς *ποθηφέυετ*ς γ*ο πολύ χρόνο ή ότ*ν ο· μπ*τ*ρι*ς έχου*ν χ*λ*δ*ο·, *πομφ*ρ*ν*τε τ*ς π*ντοτε *πό το Φορτίο μπ*τ*ρι*ς. Γ*ρ* πο*ν στ*όσε· *πό όδ*ε· ες μπ*τ*ρι*ς θ* χ*λ*δ*ο· το Φορτίο μπ*τ*ρι*ς. Επ*ν*φορτ*·ούμ*νε*ς μπ*τ*ρι*ς μ*πορού*ν γ* χρησ* μοπο·ηθ*ού*· *ήν επ*ν*φορτ*όυετ*ε τ*ς μπ*τ*ρι*ς με*ο* στο Φορτίο.

TR **Pil kutusu kullanma talimatı**
 Hiçbir zaman değişik tipteki pilleri ve eski ile yeni pilleri birarada kullanmayınız. Motoru uzun süre kullanmayacaksınız pilleri kutuda bırakmayınız. Boşalan pilleri kutudan çıkartınız. Boşalan pillerin akması pil kutusuna zarar verebilir. Şarj edilebilen pilleri de kullanabilirsiniz, ancak bu durumda güç azalabilir. Pilleri kutunun içinde şarj etmeyiniz.

MAL **Cara menggunakan kotak bateri**
 Jangan campurkan bateri lama dan baru dalam satu kotak bateri. Jika tidak menggunakan motor atau bateri kehabisan kuasa, keluarkan dari kotak. Kebocoran daripada bateri yang habis akan merosakkan kotak. Bateri yang boleh dicas boleh digunakan tetapi kuasa tenaganya berkurangan. Jangan sekali-kali mencajkan bateri di dalam kotak.

日本語 **電池ケース使用上のご注意**
 異なる種類の電池や、古い電池と新しい電池を混ぜて使用することは避けください。電池の寿命が切れた場合、または長期間使用しない場合には、ケースから電池を抜いてください。切れた電池から液が漏れて、電池ケースを損なうこととなります。充電式電池も使用できますが、パワーは弱くなる場合があります。なお、電池ケースの中で充電しないようご注意ください。

中文 **電池盒使用说明**
 切勿在同一个電池盒內同時使用不同類型的電池或混合新舊電池。需要長期藏貯電池或者電池已經用盡的話，請把電池從電池盒內取出。從廢電池漏出來的液體會損壞電池盒。您可以使用充電式電池，但它們的電力比較弱。進行充電時，請勿把電池留在電池盒內。

عربي **تعليمات استعمال صندوق البطارية**
 يجب عدم خلط أنواع مختلفة من البطاريات، أو خلط البطاريات القديمة مع الجديدة في صندوق بطارية واحد. كما يجب دائماً مراعاة إزالة البطاريات من صندوق البطارية، عند حفظها وعدم استعمالها لمدة طويلة أو عند إنتهاء فعالية طاقتها. كما وأنه يجب الأخذ في الإعتبار أن تسرب السائل من البطاريات القديمة التي إنتهت فعالية طاقتها يؤدي إلى تلف صندوق البطارية. يمكن إستعمال البطاريات التي يعاد شحنها، إلا أن ذلك قد يؤدي إلى تقليل وانخفاض الطاقة. يجب عدم إعادة شحن البطاريات في صندوق البطارية.

한국어 **전전지 박스 사용법**
 전전지 박스에는 알카라인 전전지와 일반 전전지를 함께 사용하지 마시고, 오래 된 전전지와 새 전전지도 함께 사용하지 마십시오. 전전지의 수명이 다한 경우나 장기간 사용하지 않을 때에는 항상 전전지 박스로부터 전전지를 제거해서 주십시오. 수명이 다한 전전지에서 액체가 나오면 전전지 박스를 상하게 합니다. 충전지는 사용이 가능하나 전력은 약해질 수 있습니다. 전전지를 전전지 박스에서 충전하지 마십시오.

TH **วิธีการใช้กล่องแบตเตอรี่**
 อย่าใช้แบตเตอรี่ต่างชนิดปนกัน หรือใช้แบตเตอรี่ที่เก่าพร้อมกับแบตเตอรี่ใหม่ในกล่องแบตเตอรี่ ตรวจสอบแบตเตอรี่ออกทุกครั้ง เมื่อไม่ได้ใช้งานเป็นเวลานาน หรือเมื่อแบตเตอรี่หมดอายุ นำยาที่รั่วออกจากแบตเตอรี่ที่หมดอายุแล้วทิ้งให้ห่างจากแบตเตอรี่เสียหายได้ สามารถใช้แบตเตอรี่ประเภทชาร์จไฟได้ แต่กำลังไฟ อาจลดลง ห้ามชาร์จแบตเตอรี่ในกล่องใส่แบตเตอรี่





1

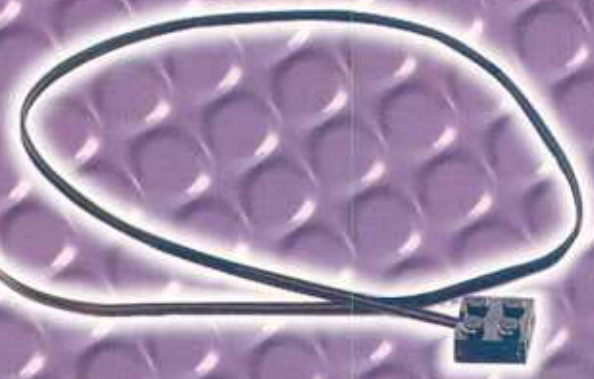

2

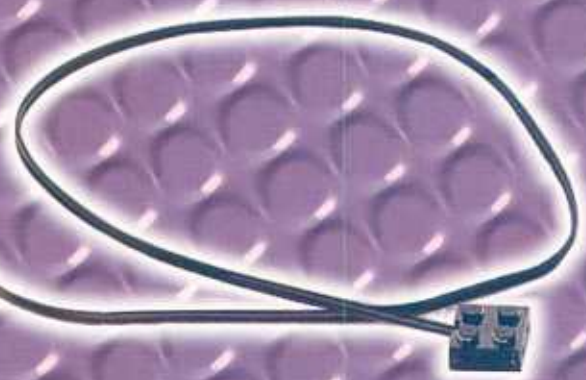

3





4

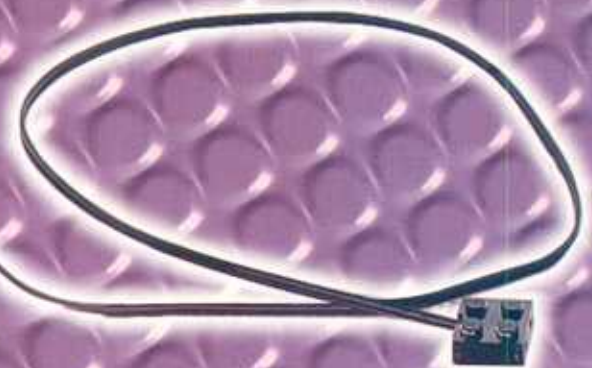

5

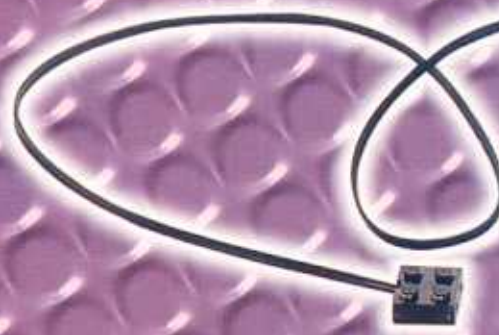

6

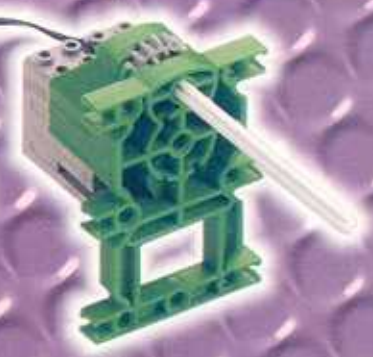

7

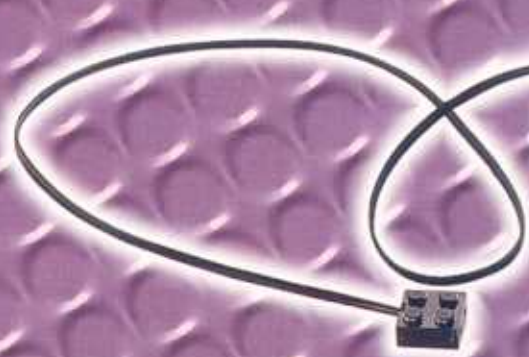

1

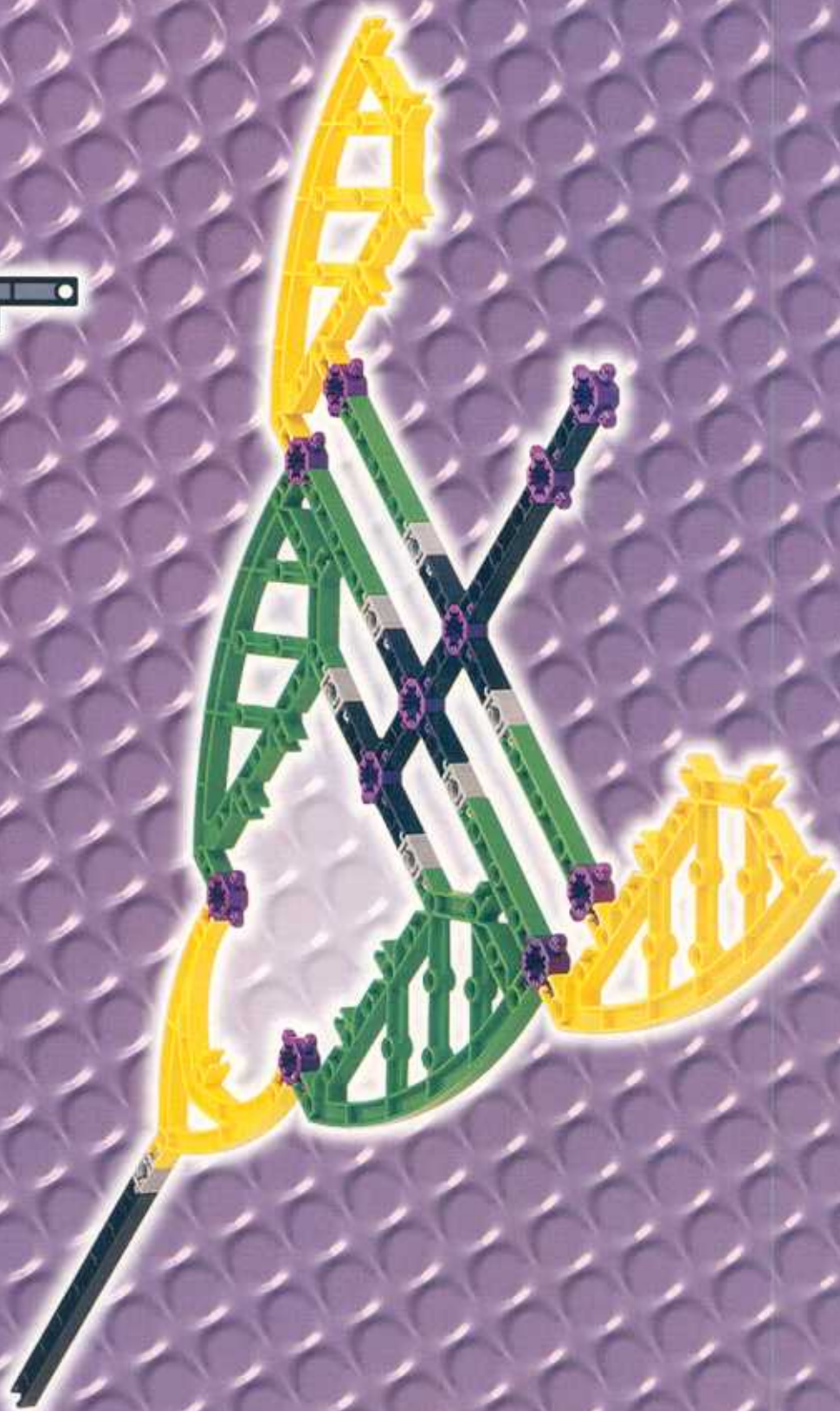

2

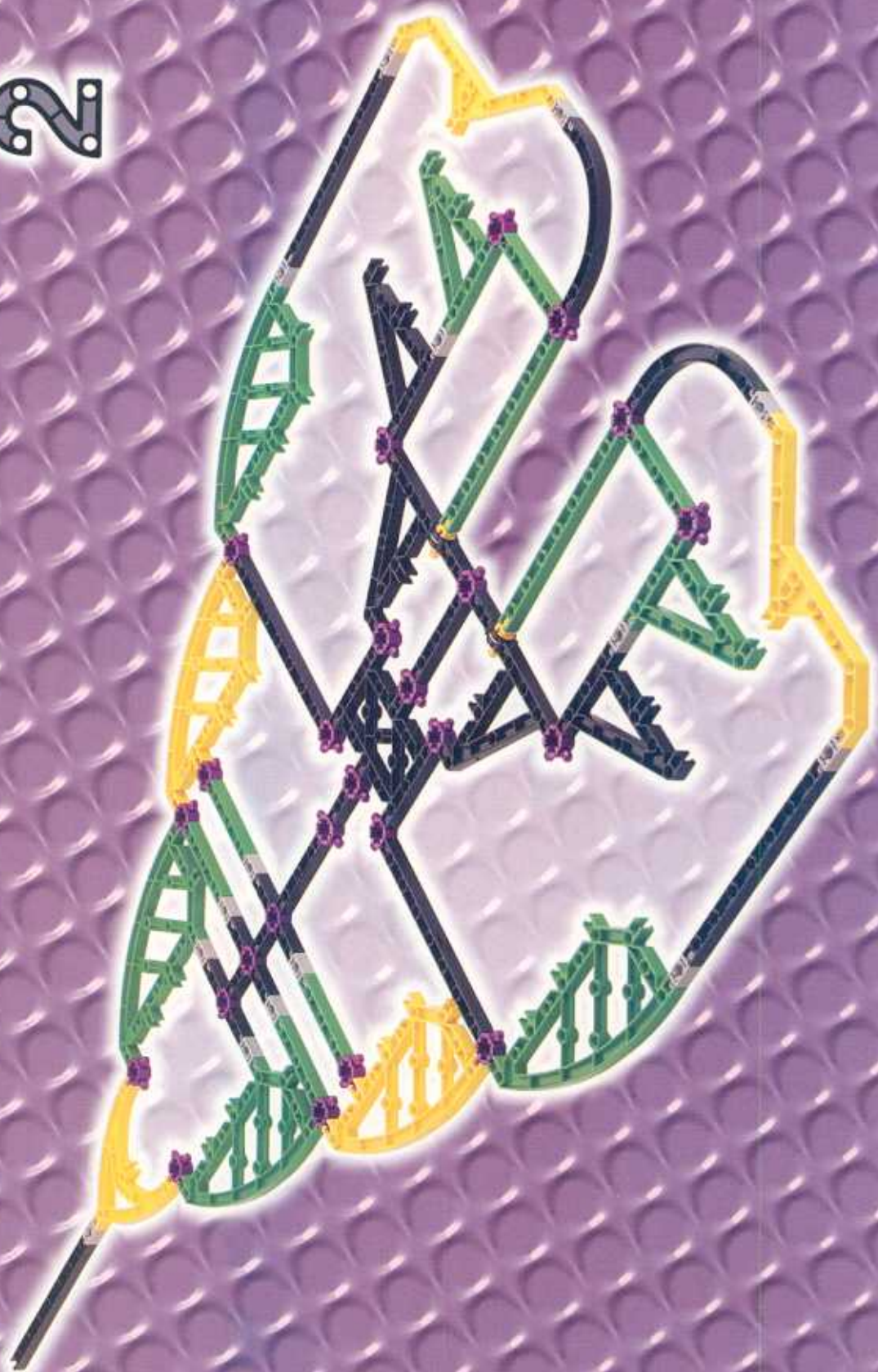

3

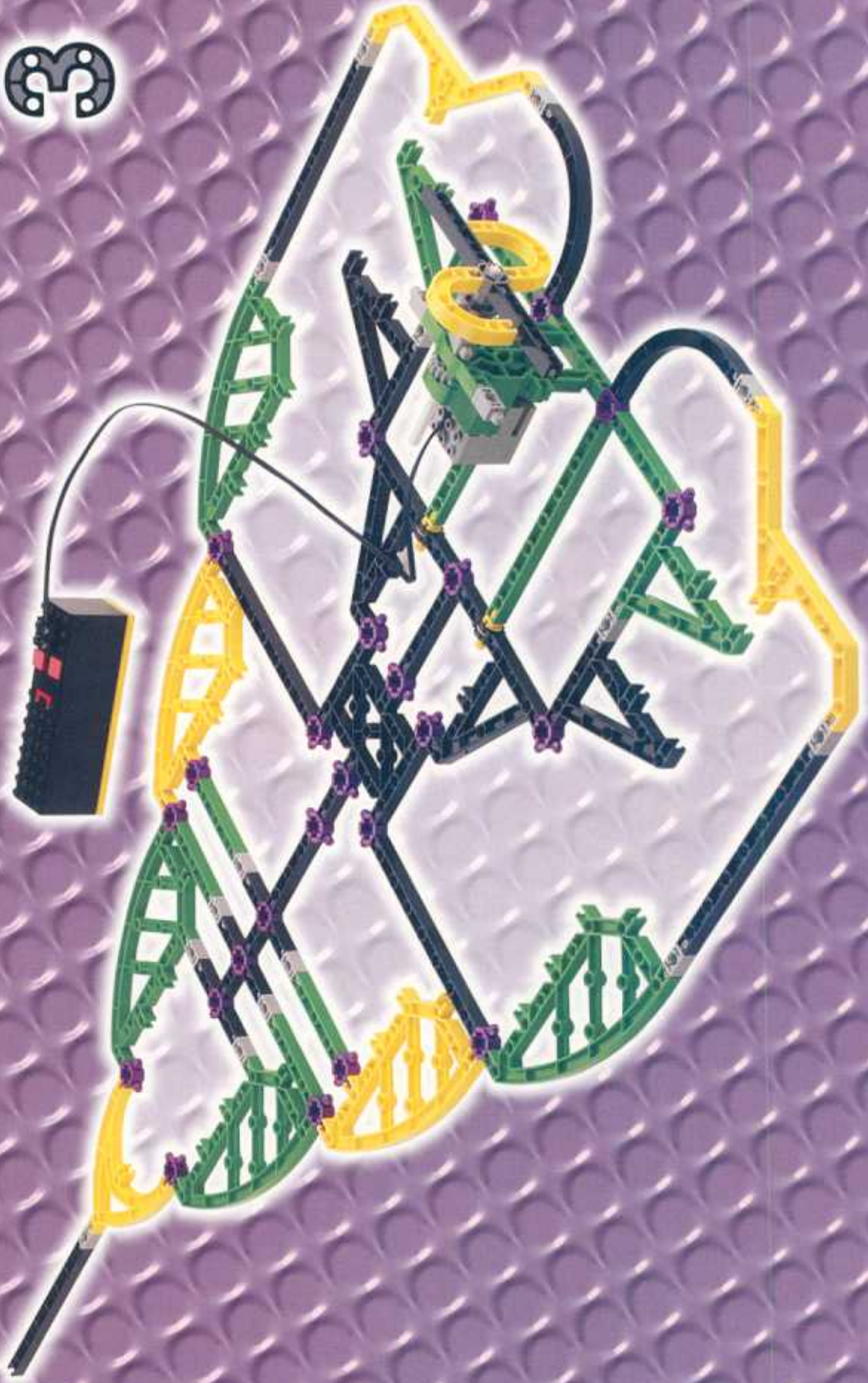



1



2

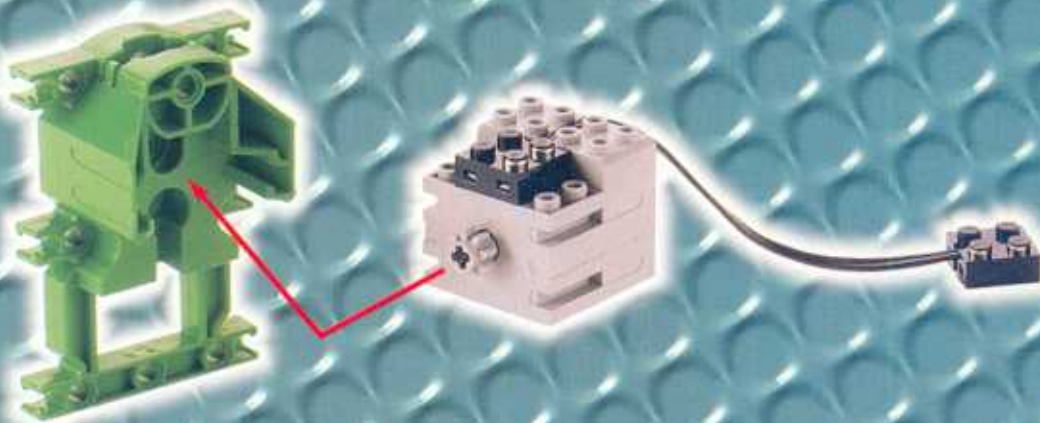

3

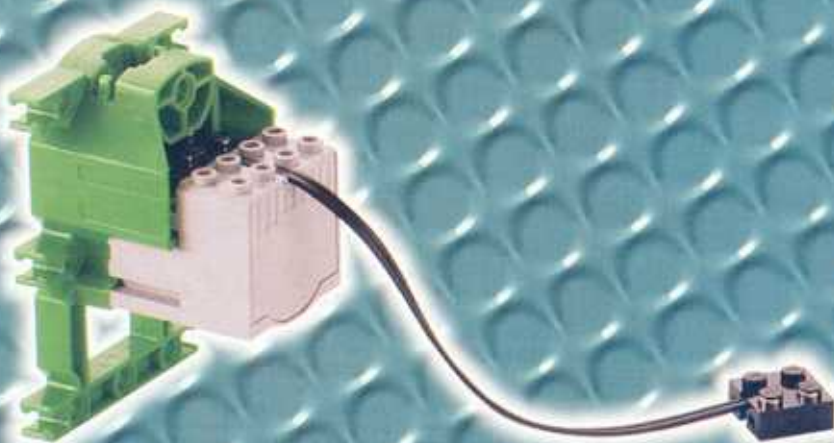

4



5

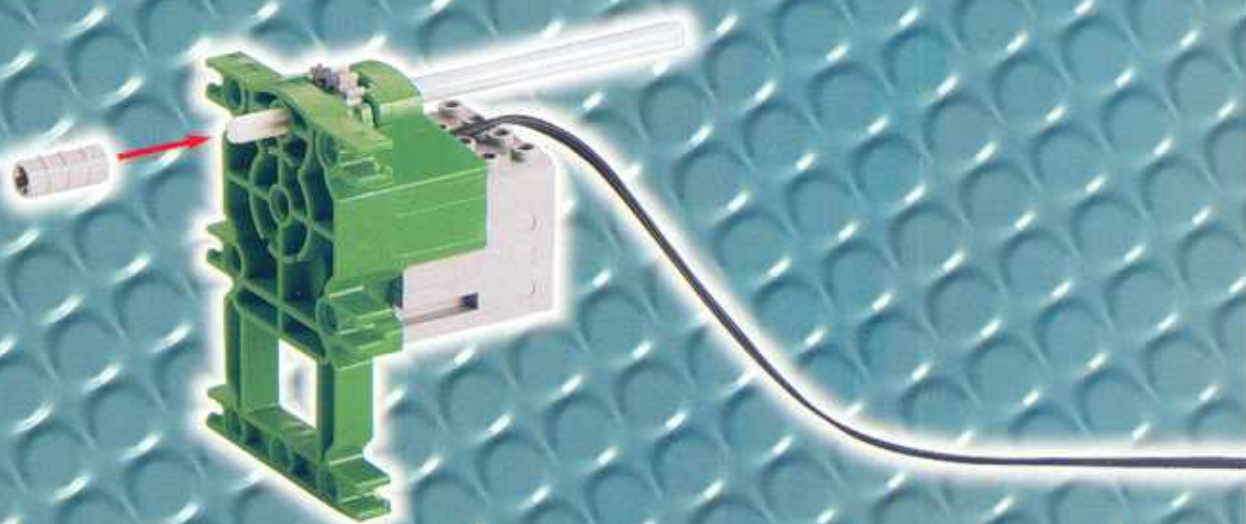

1



2



3

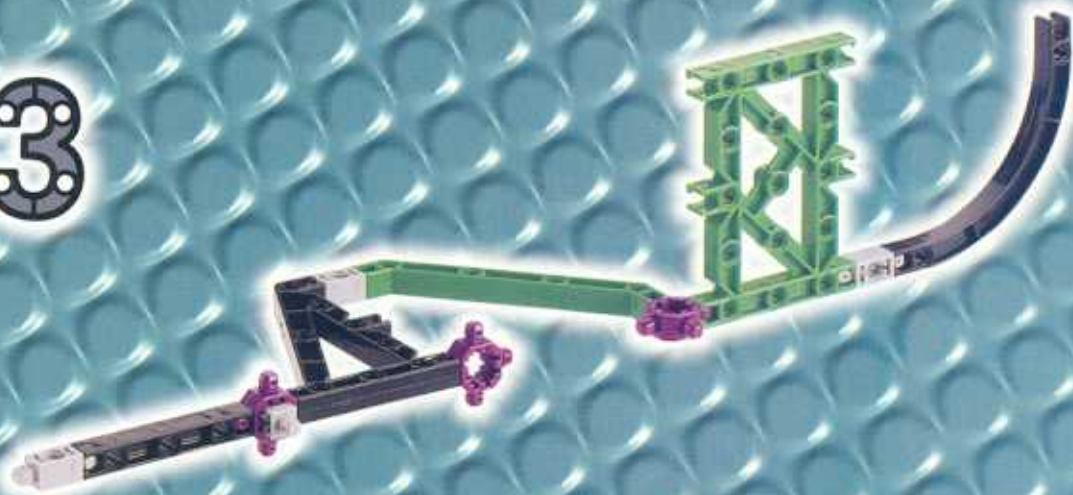

4

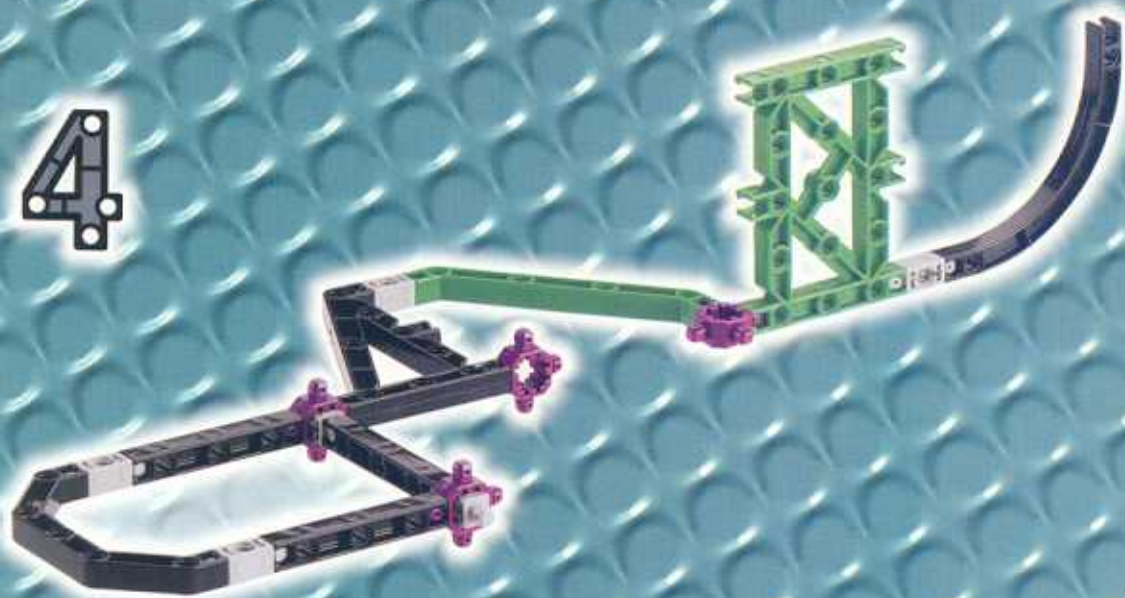

5

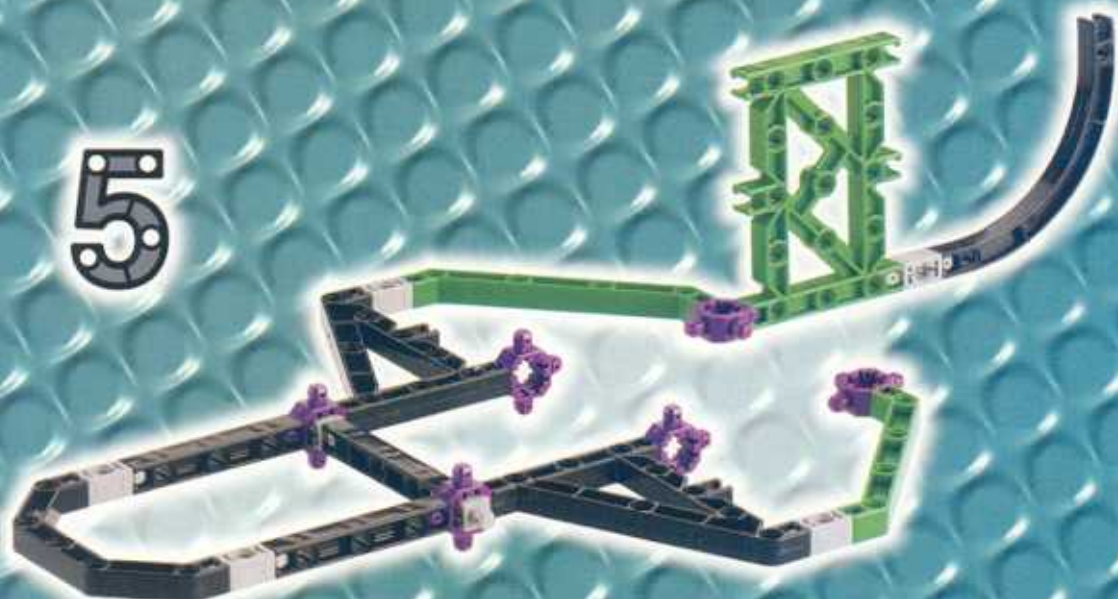

6

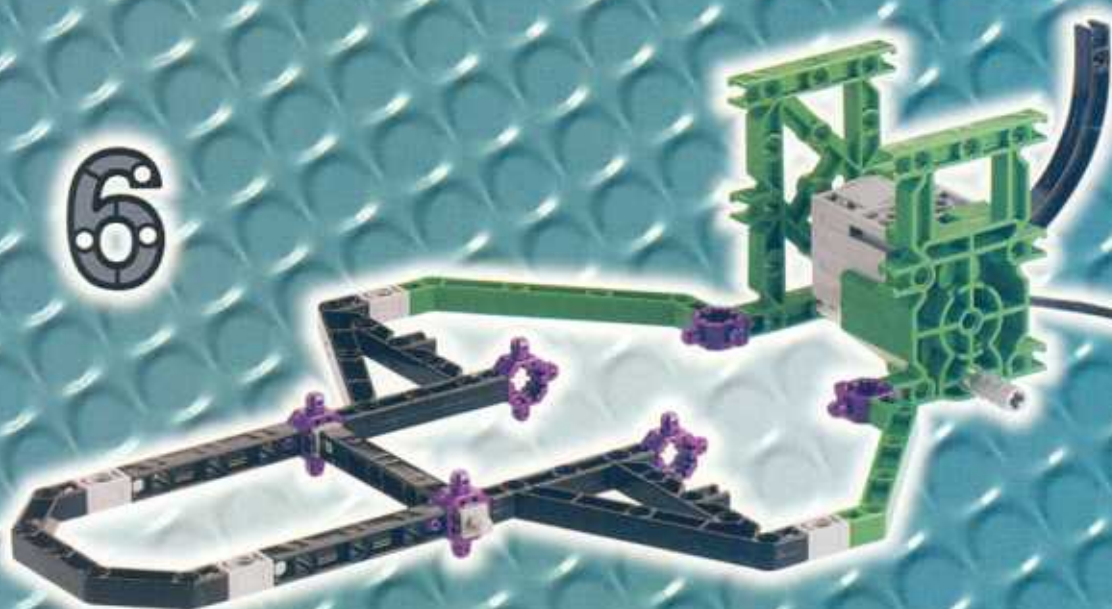

7

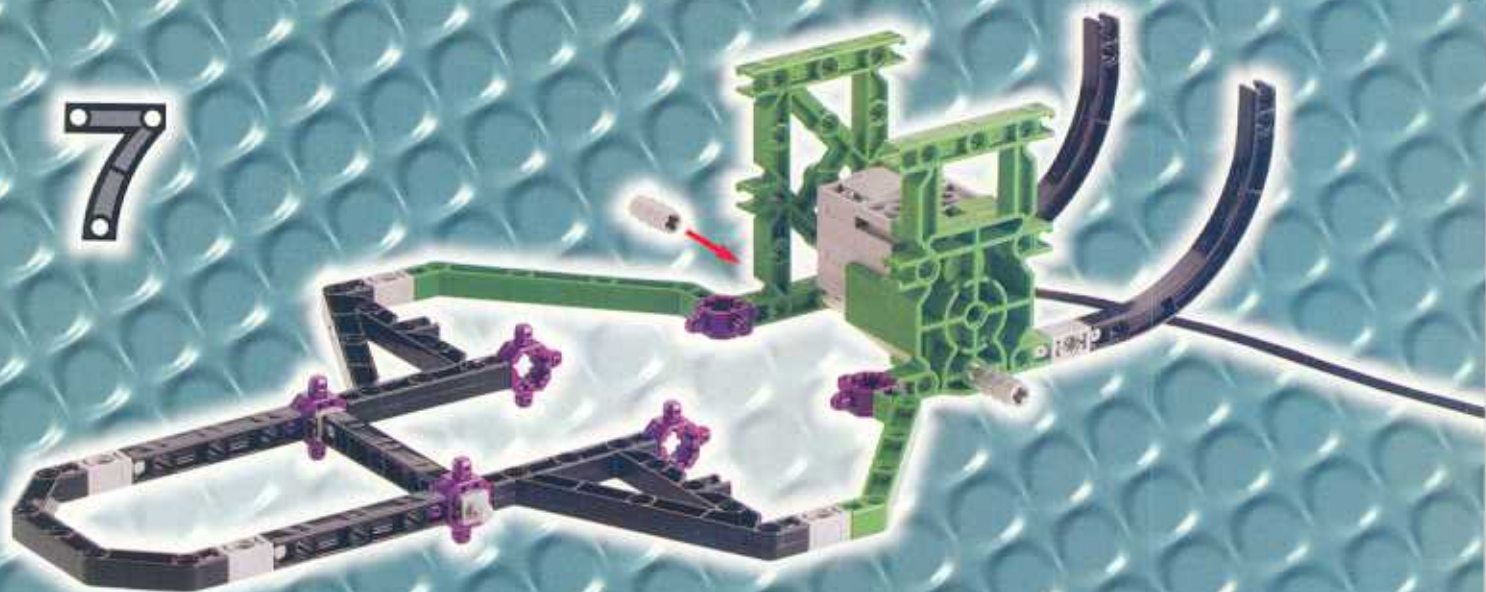

8

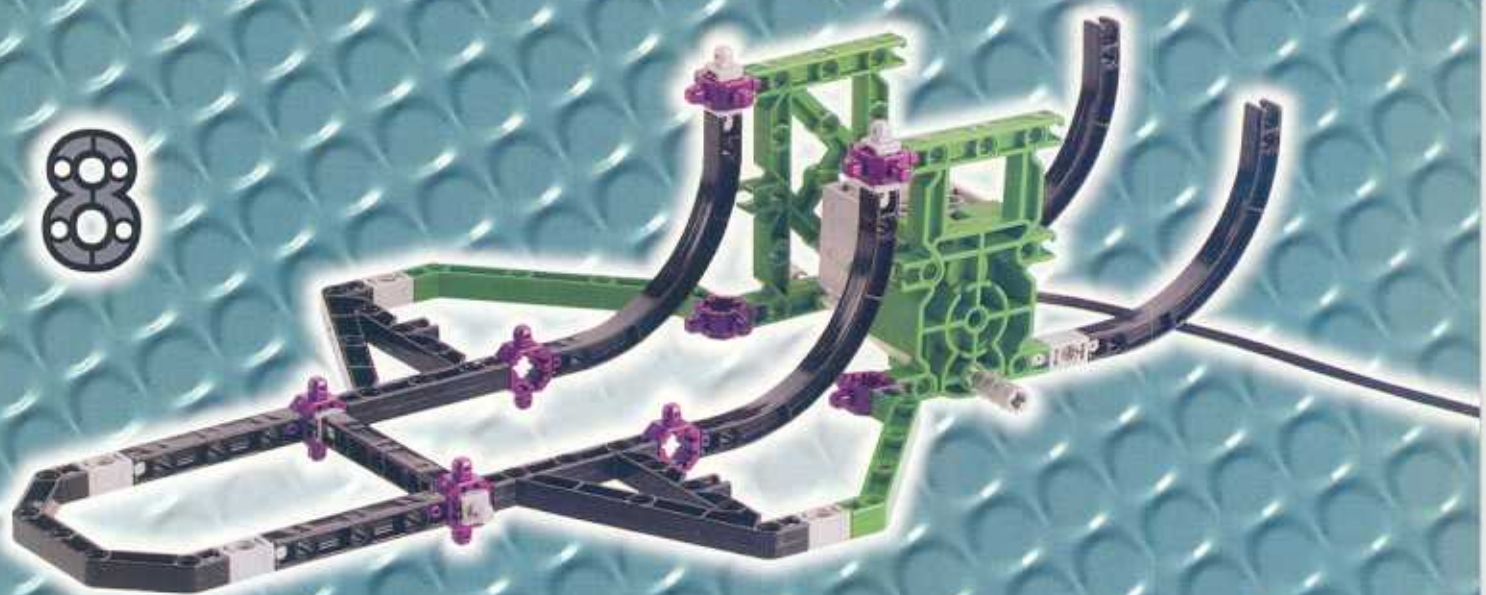

9

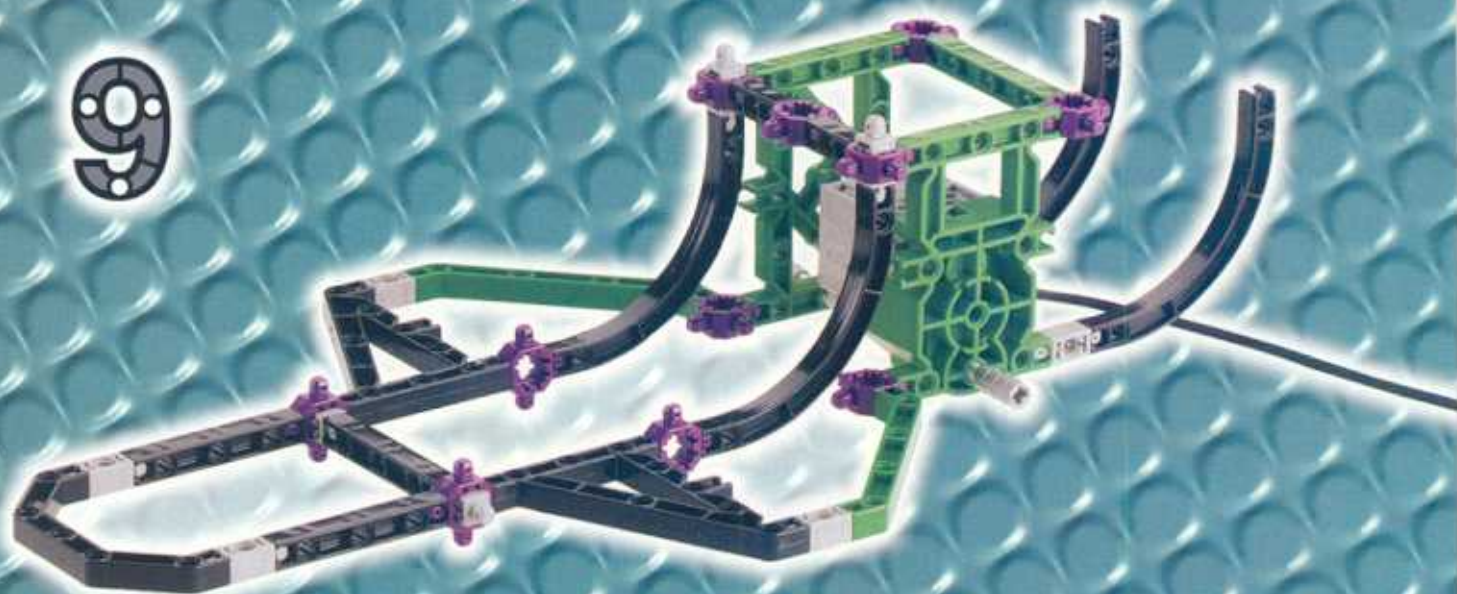

10

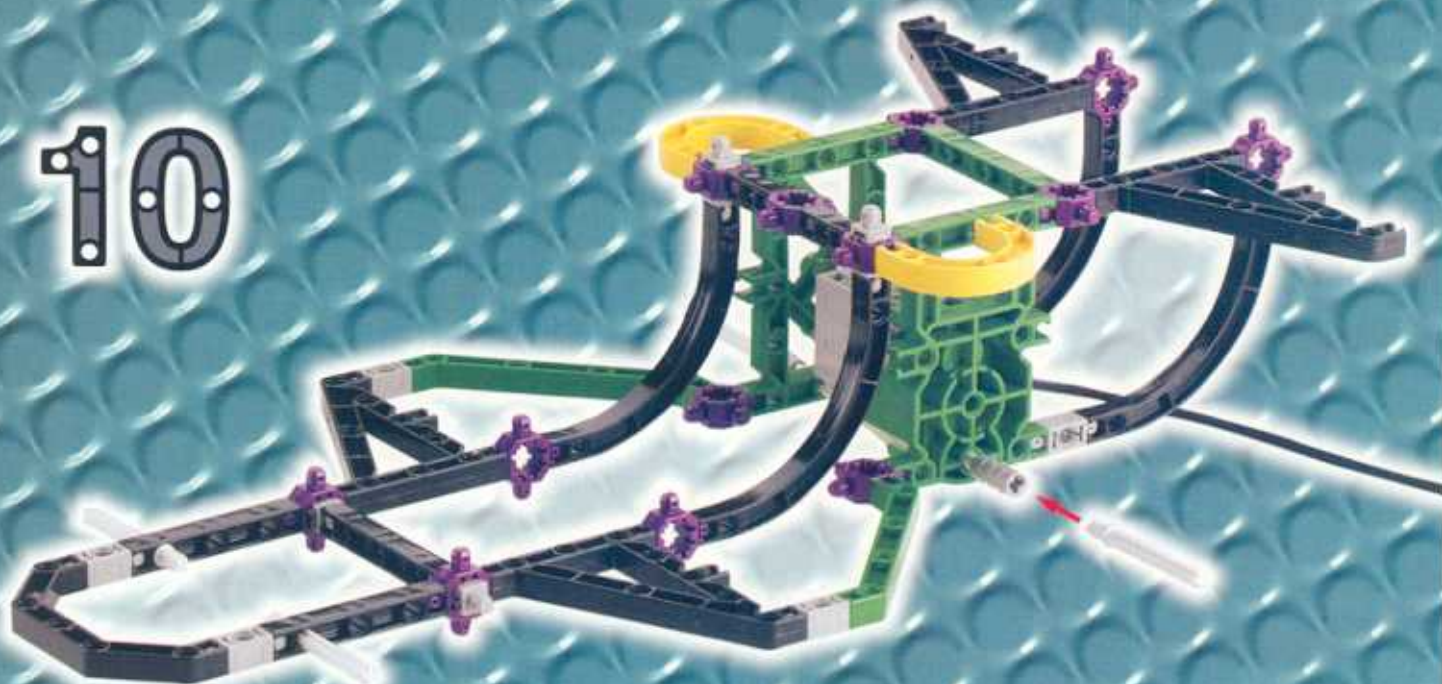

11

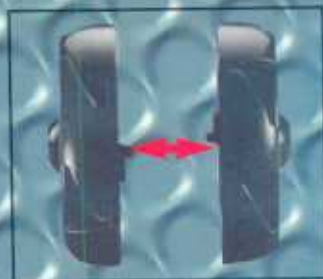

12





1



2



3

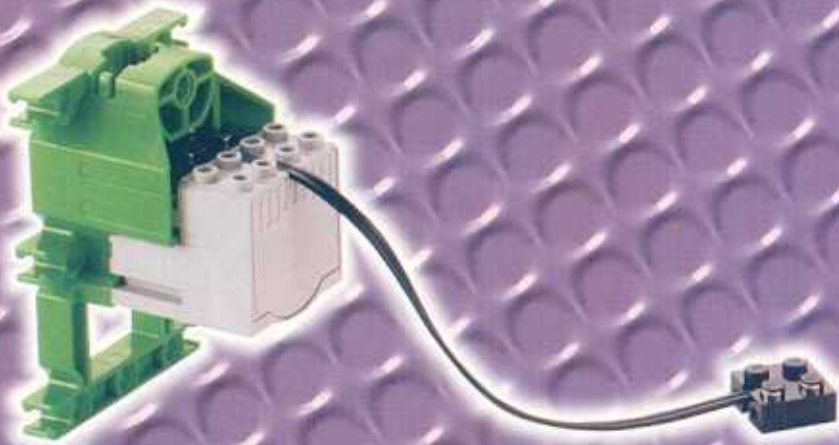

4

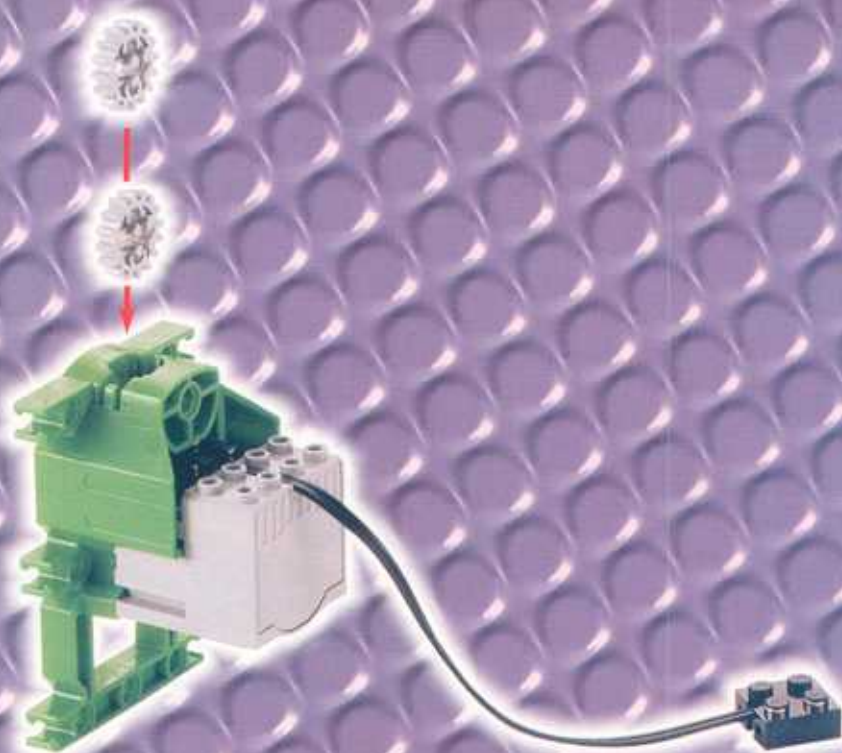

5

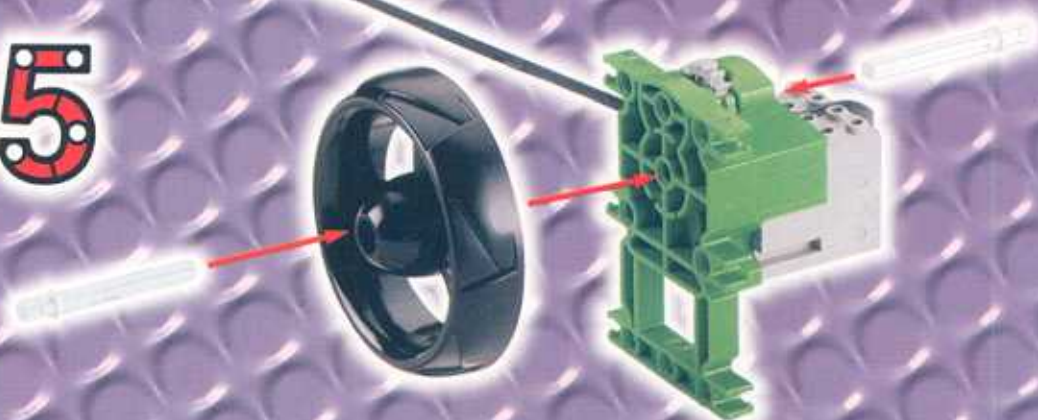

6

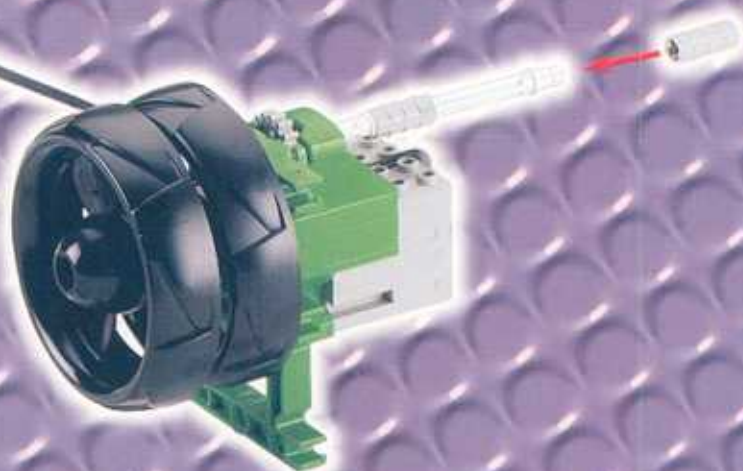

1



2



3

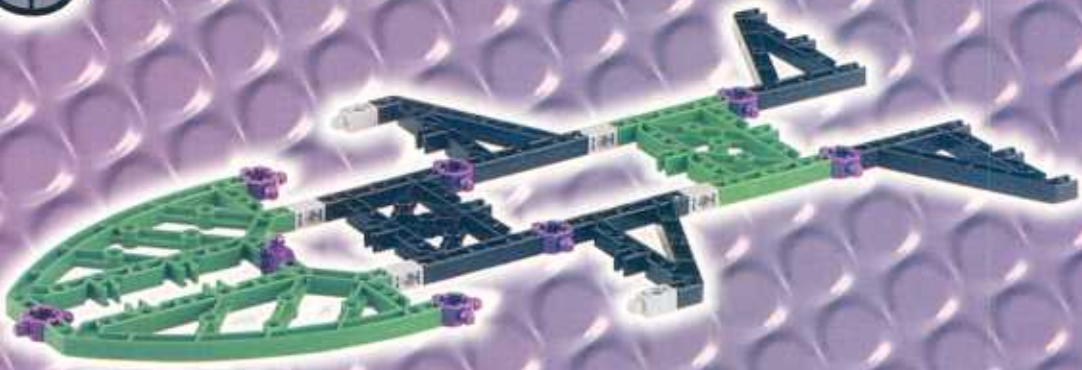

4

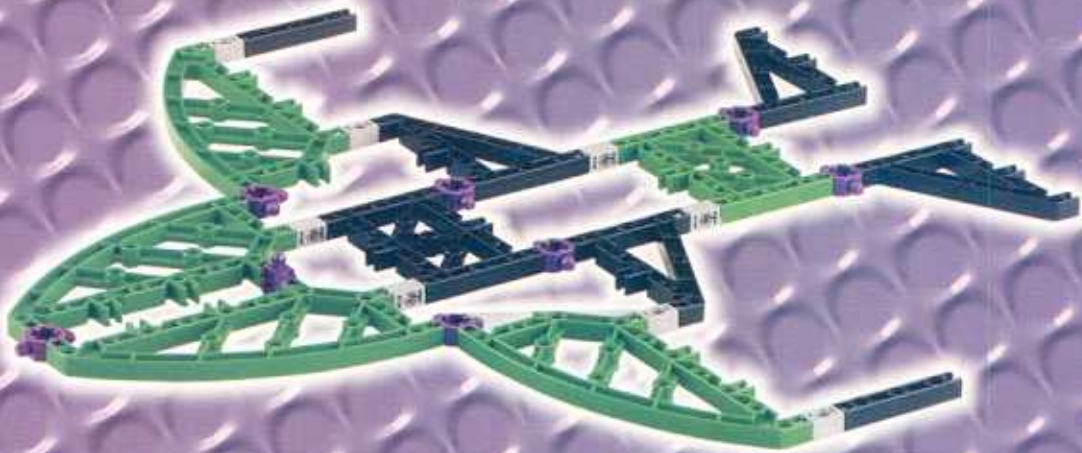

5

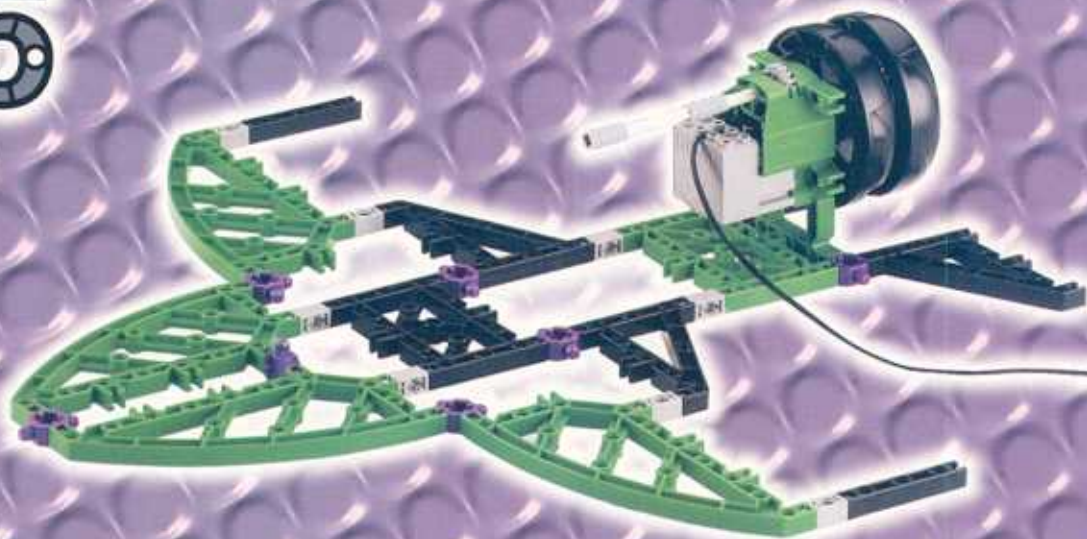

6



7



8

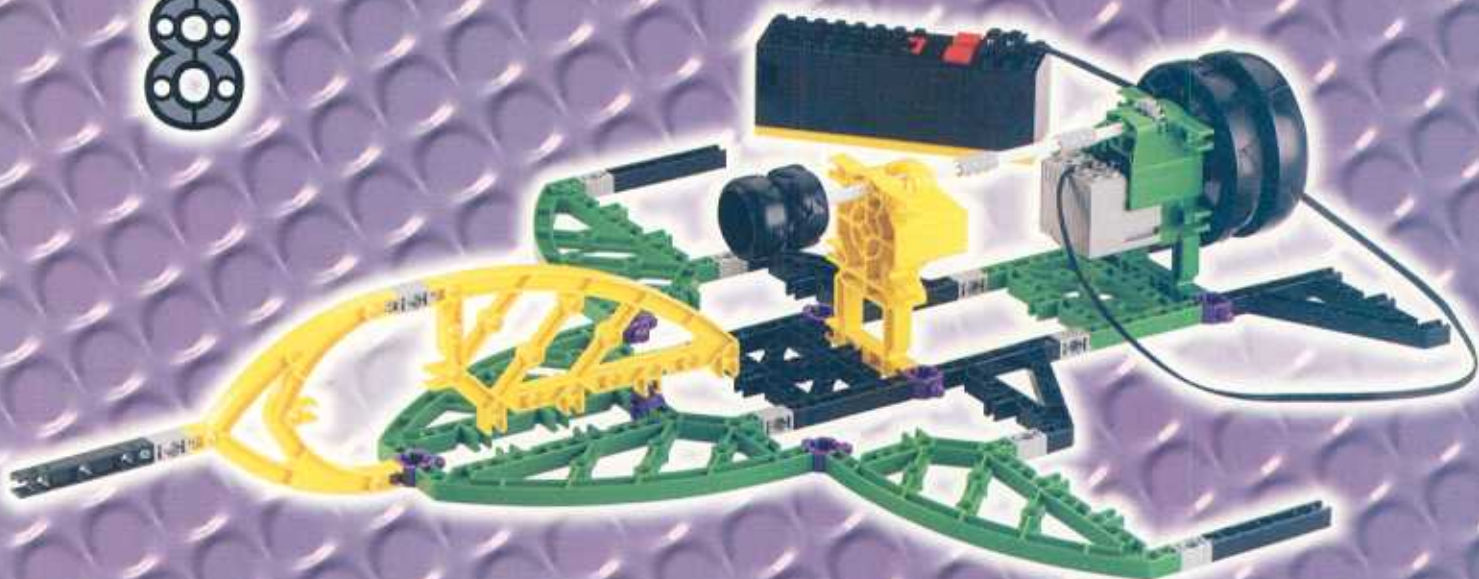

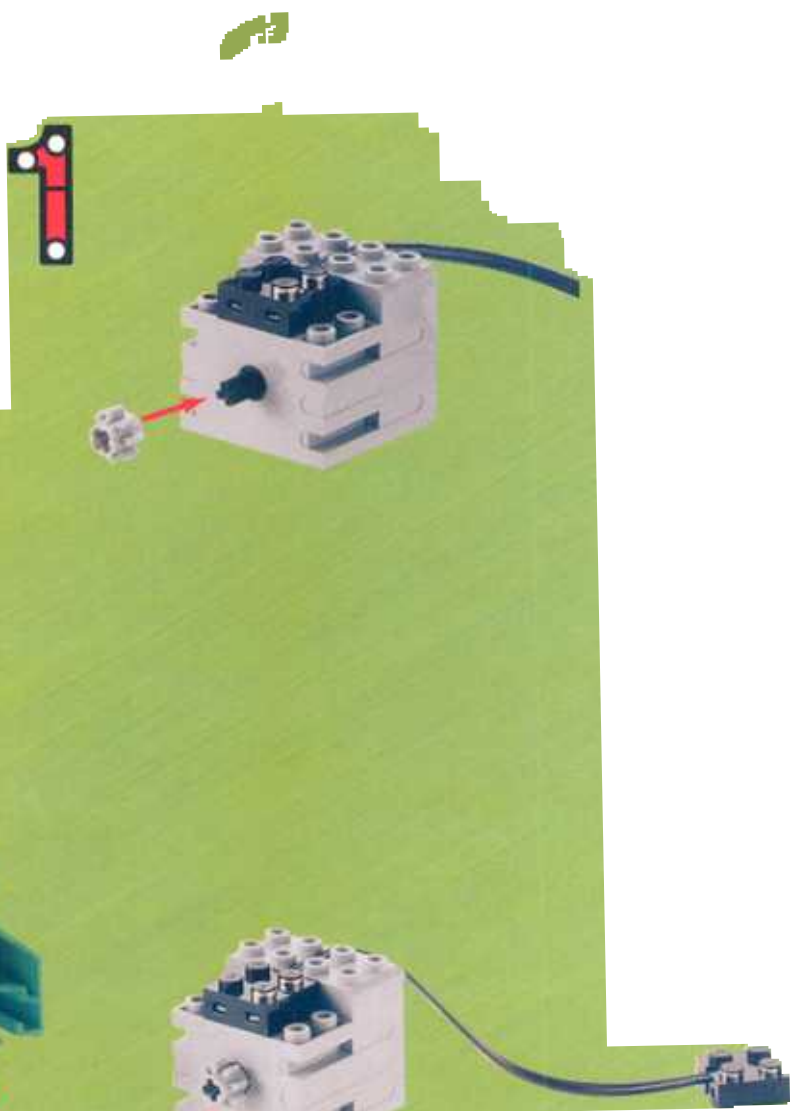

2

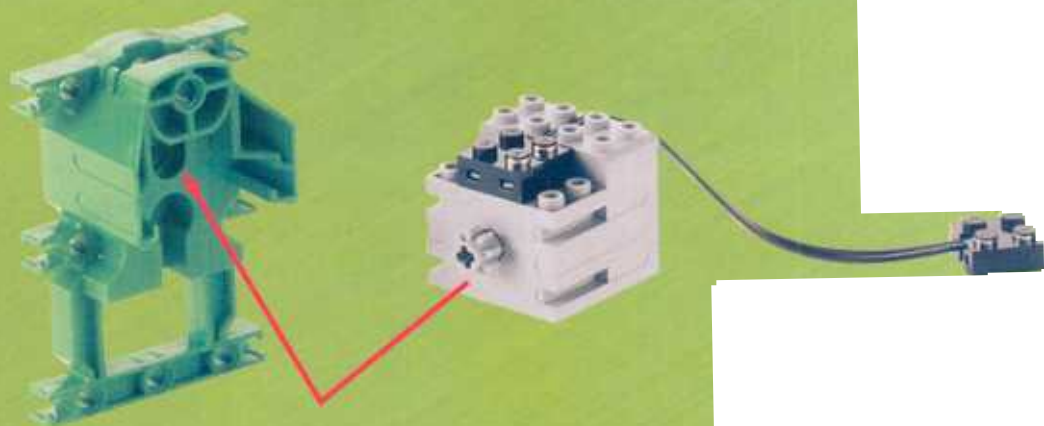

3

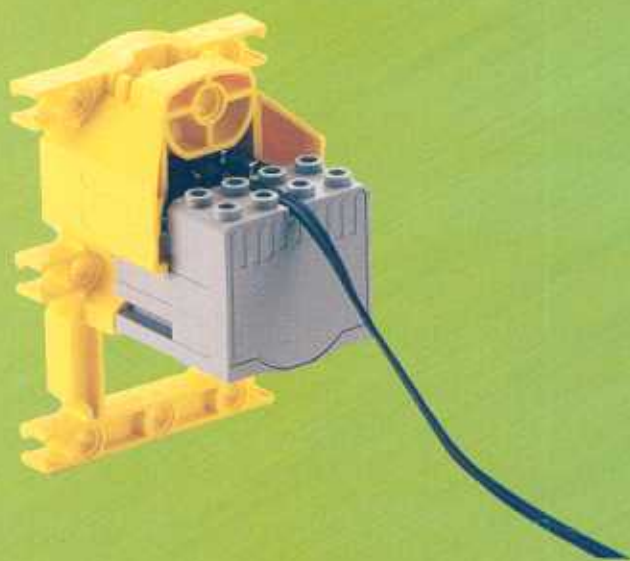

4

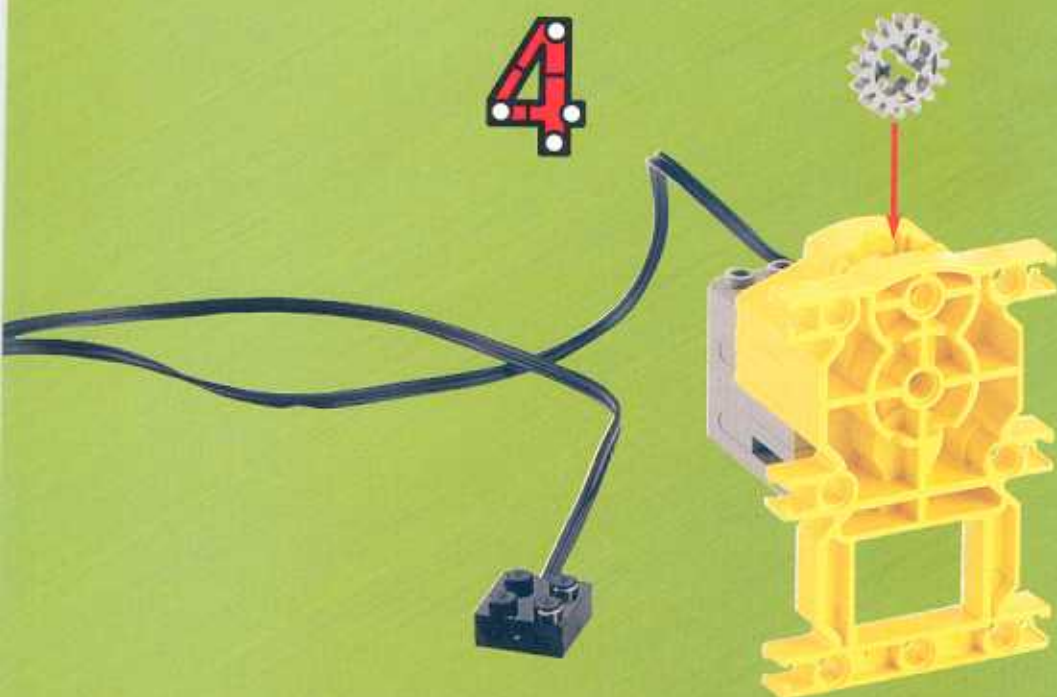

5

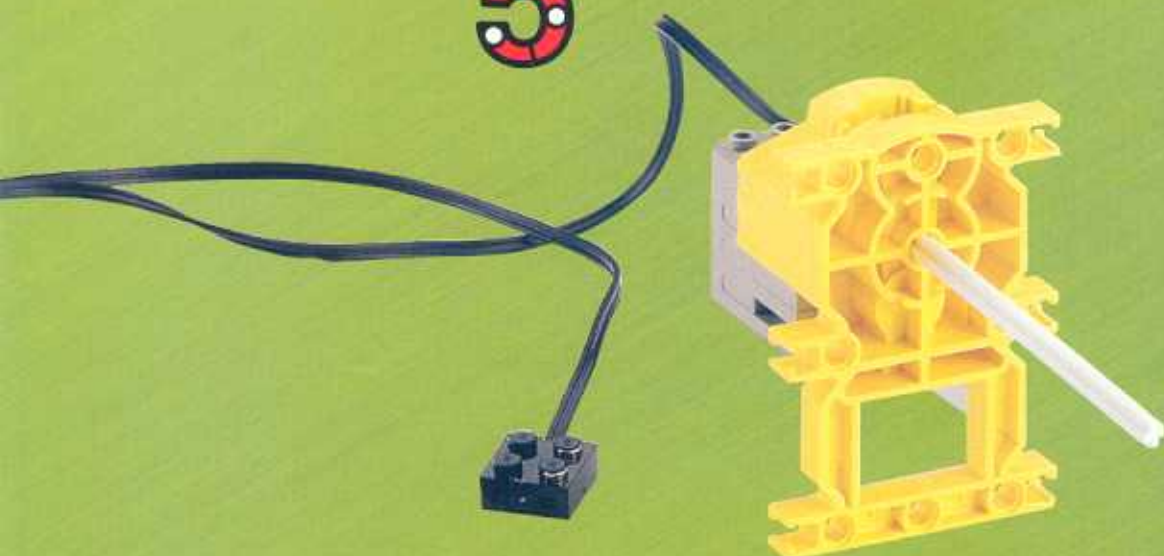

1

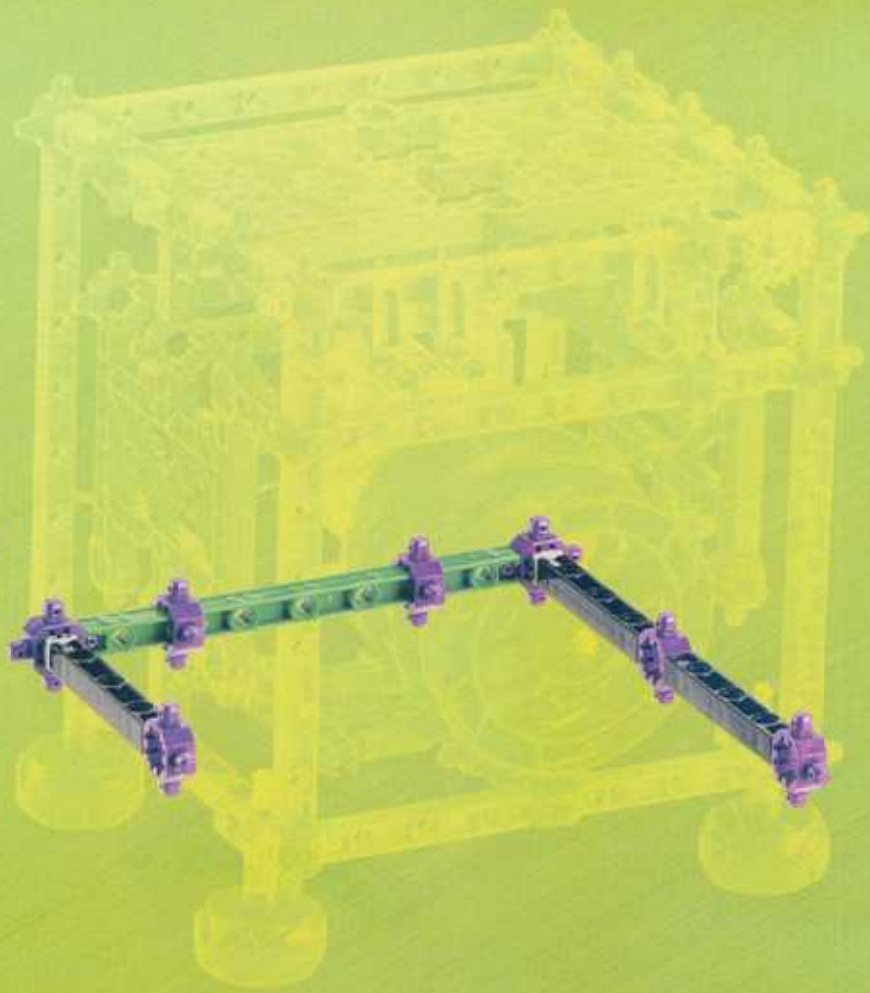

2

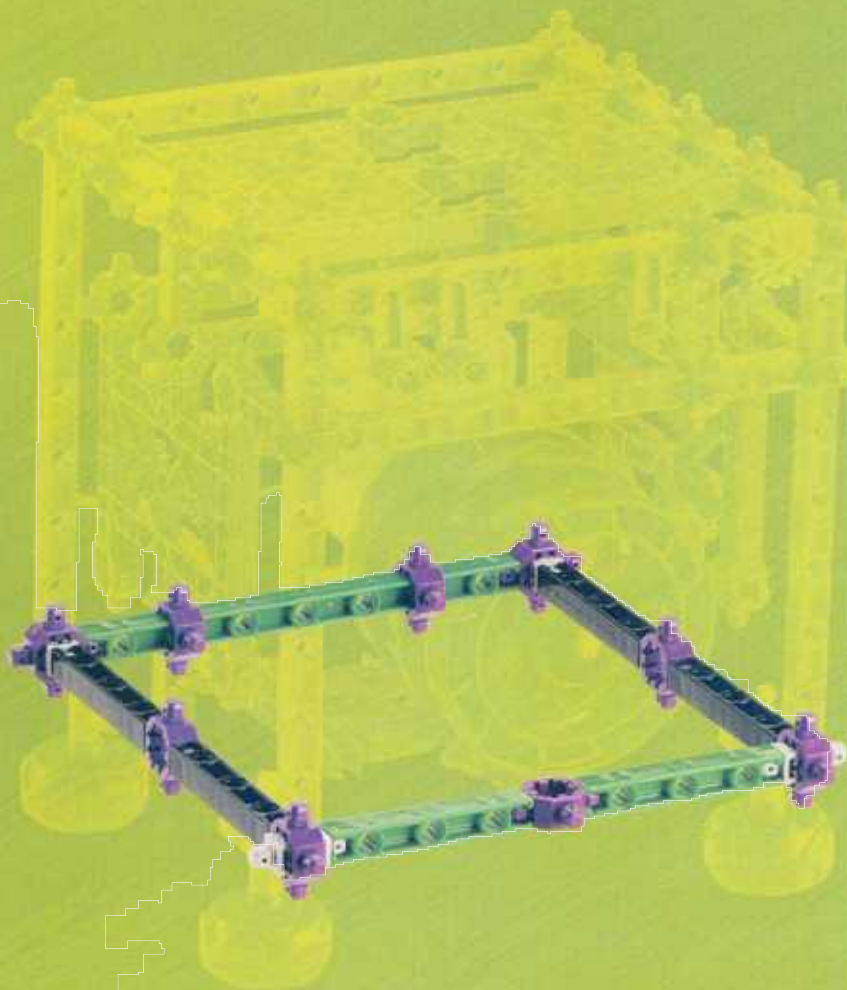

3

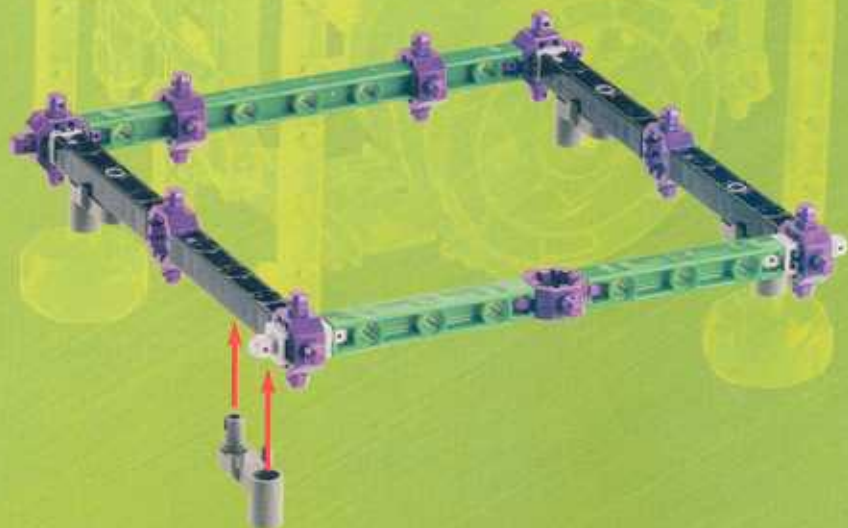

4

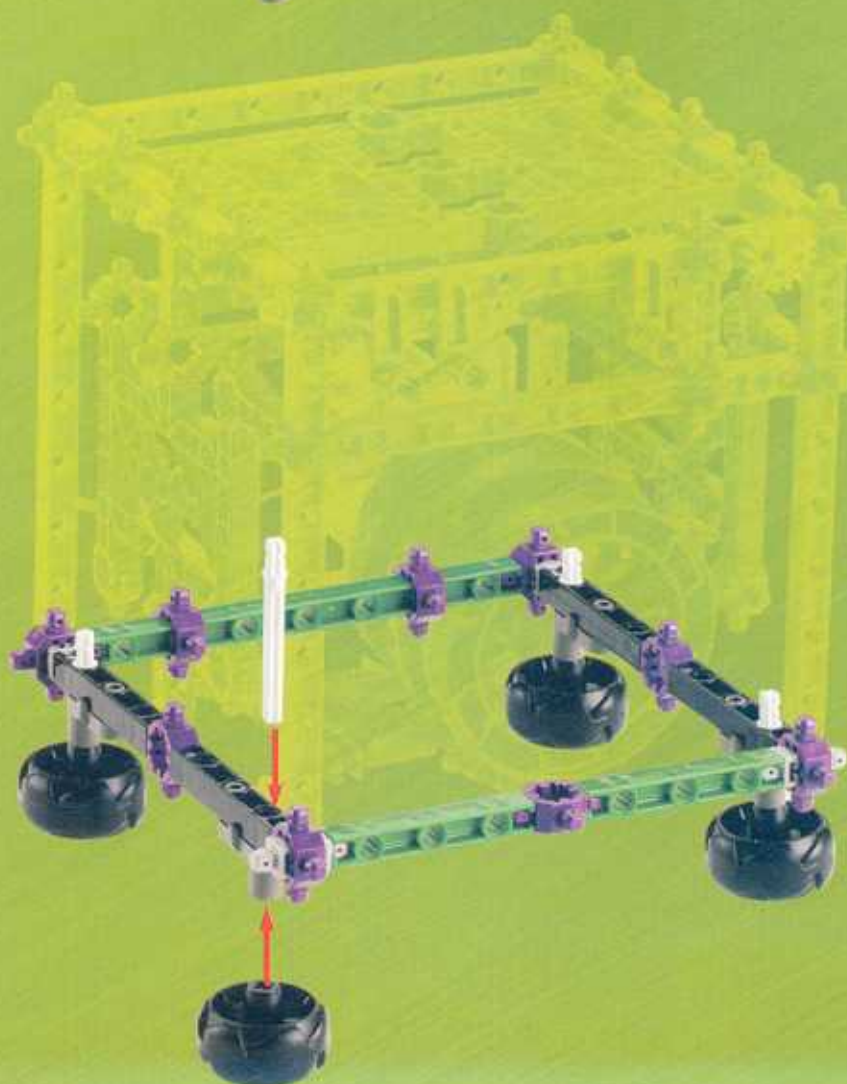

5



6



7

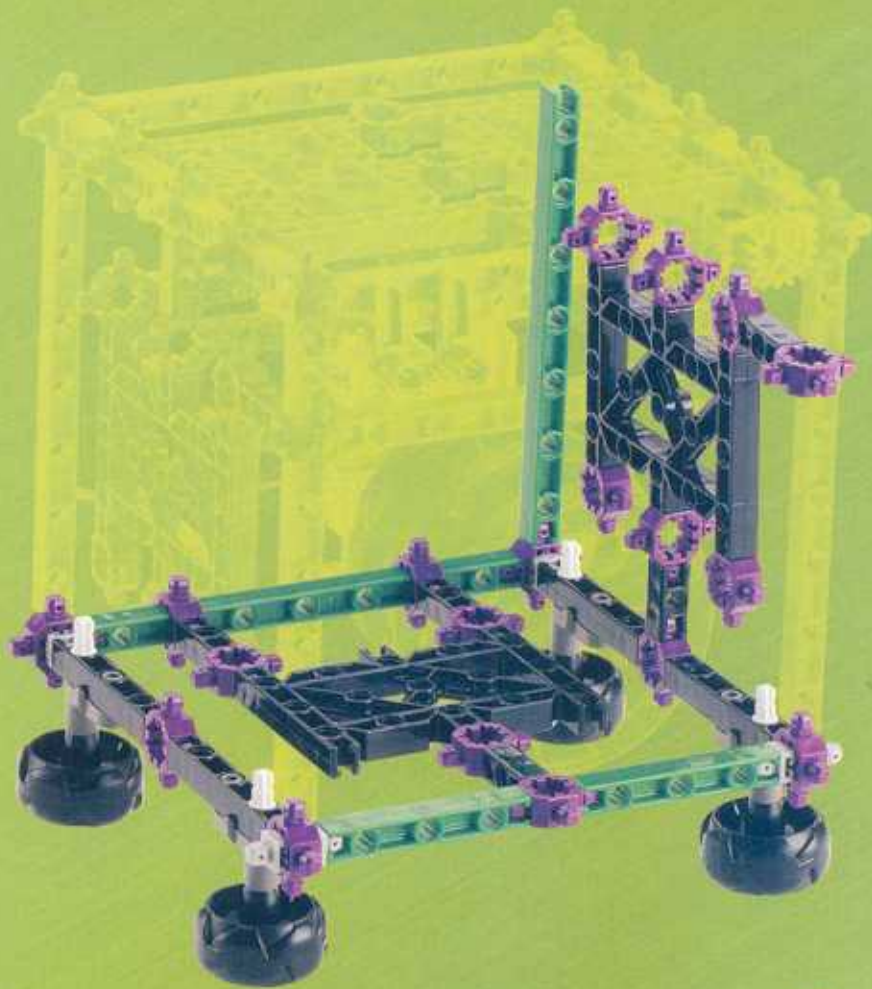

8

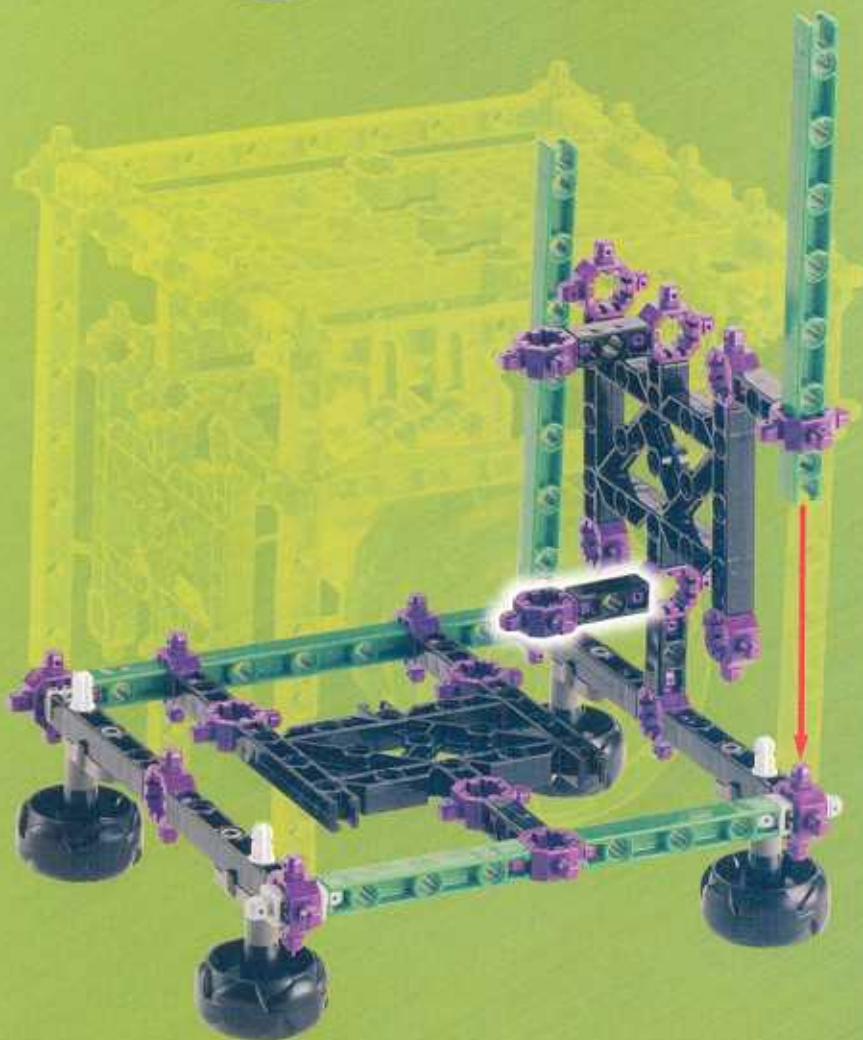

9

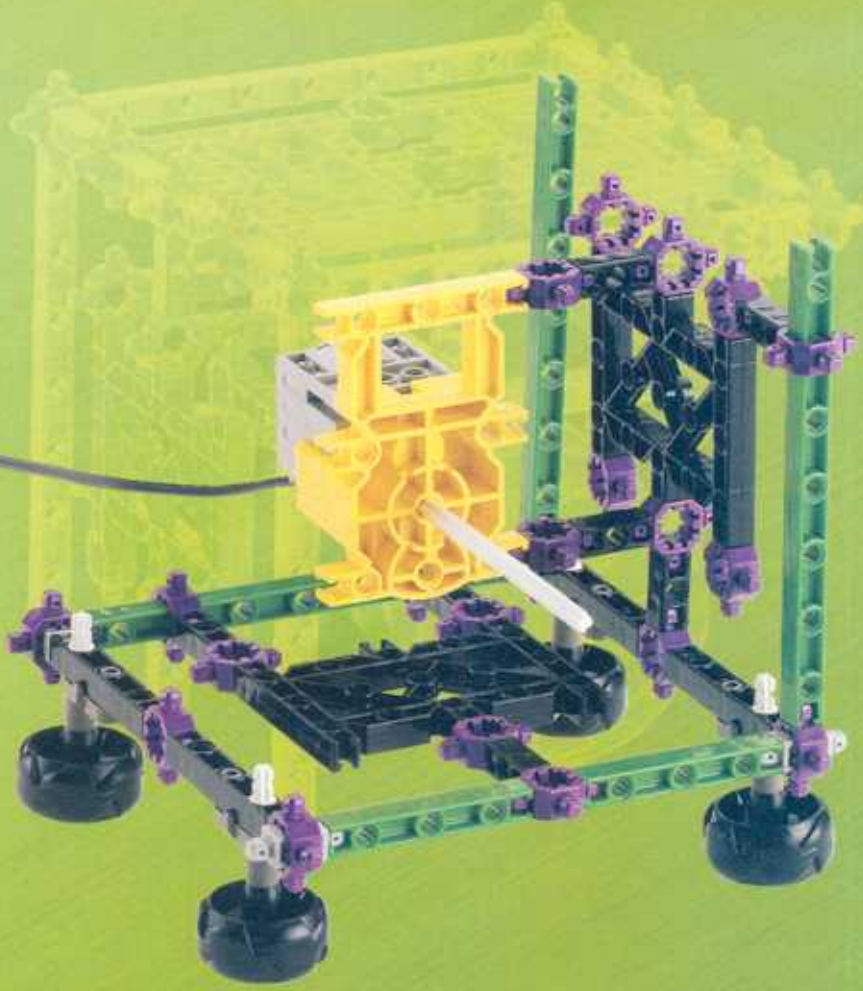

10

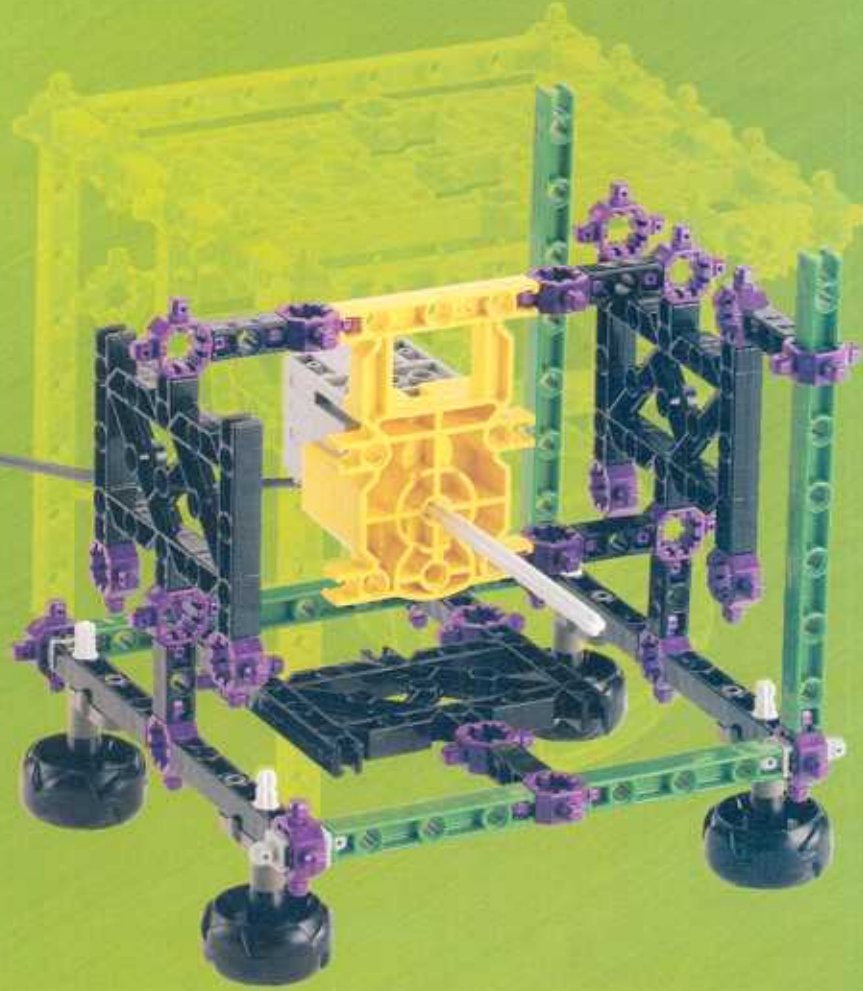

11

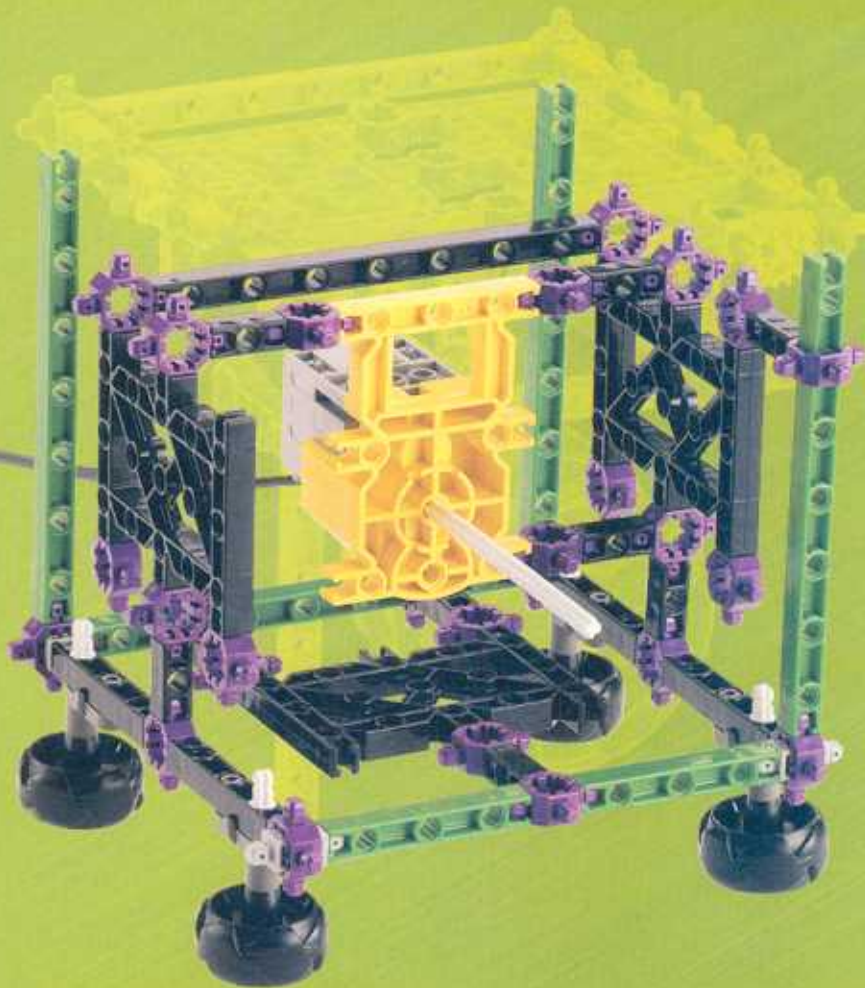

12

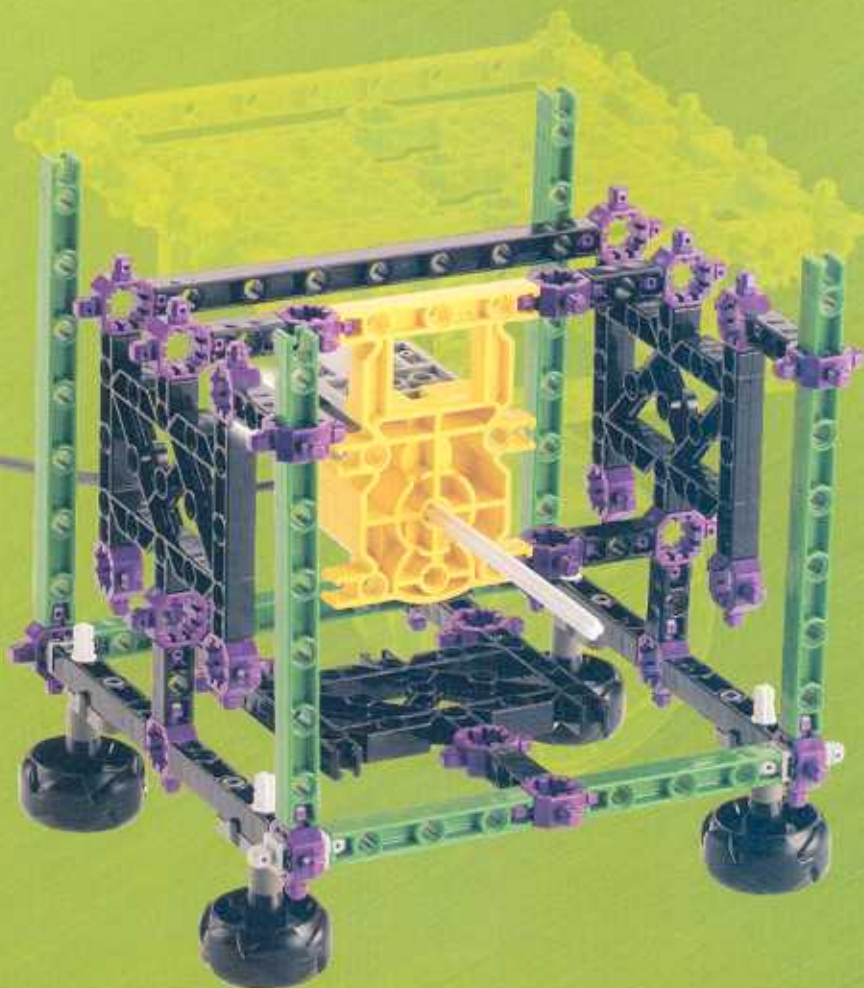

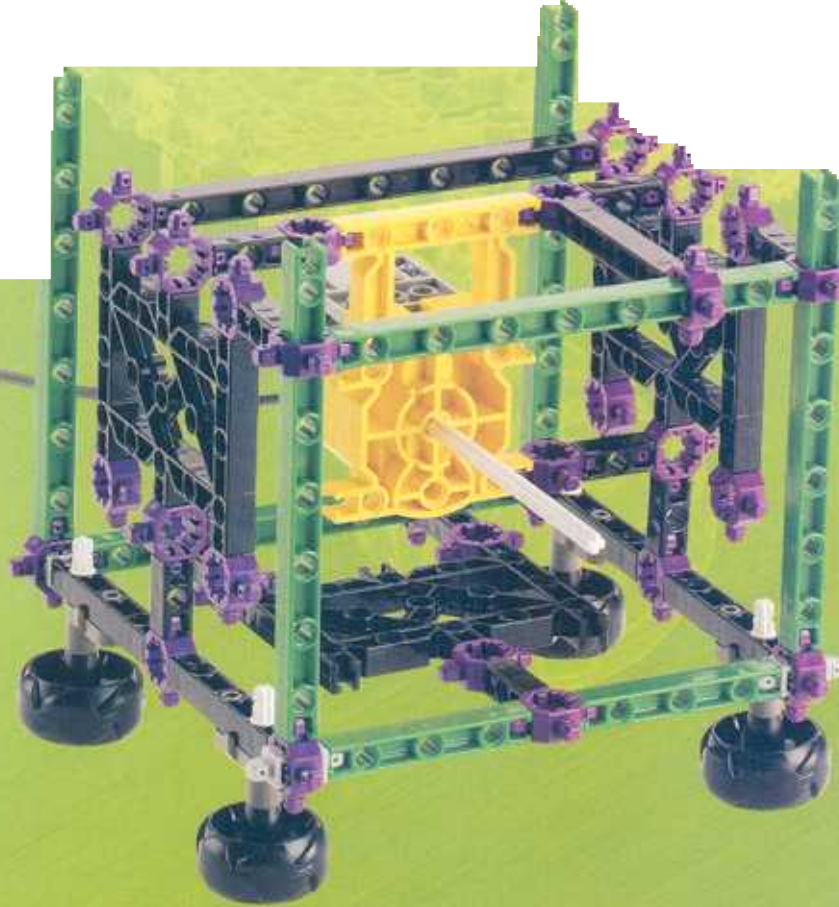

14

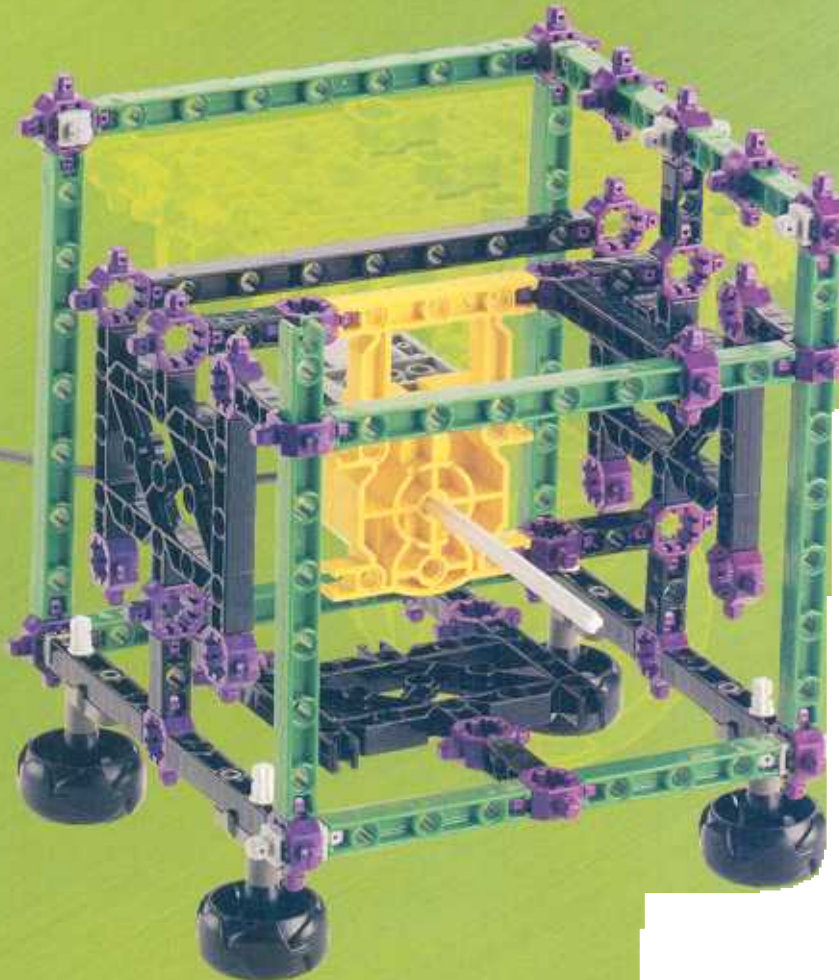

15



16

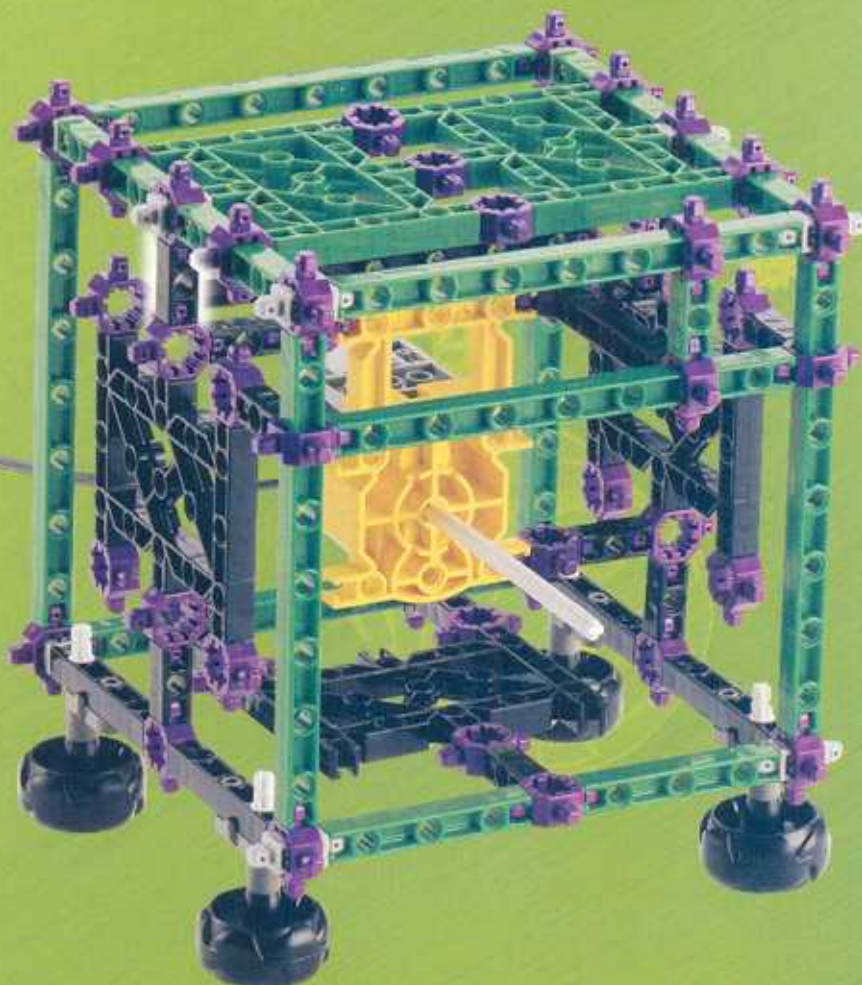

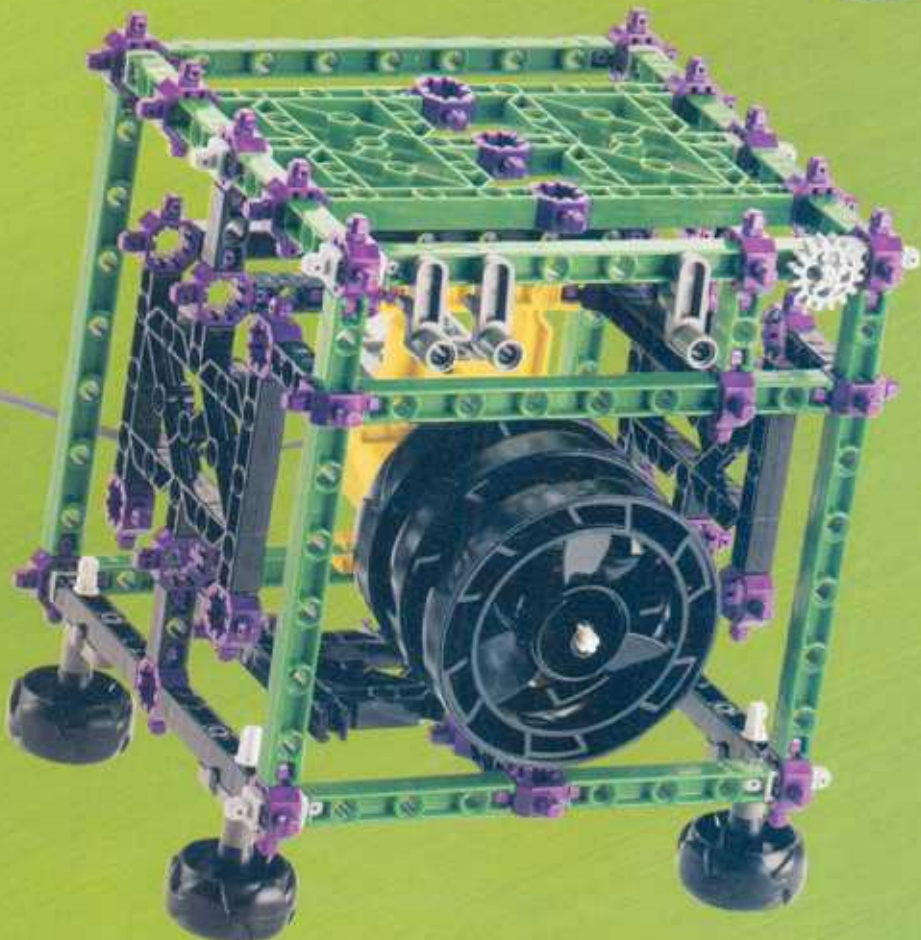
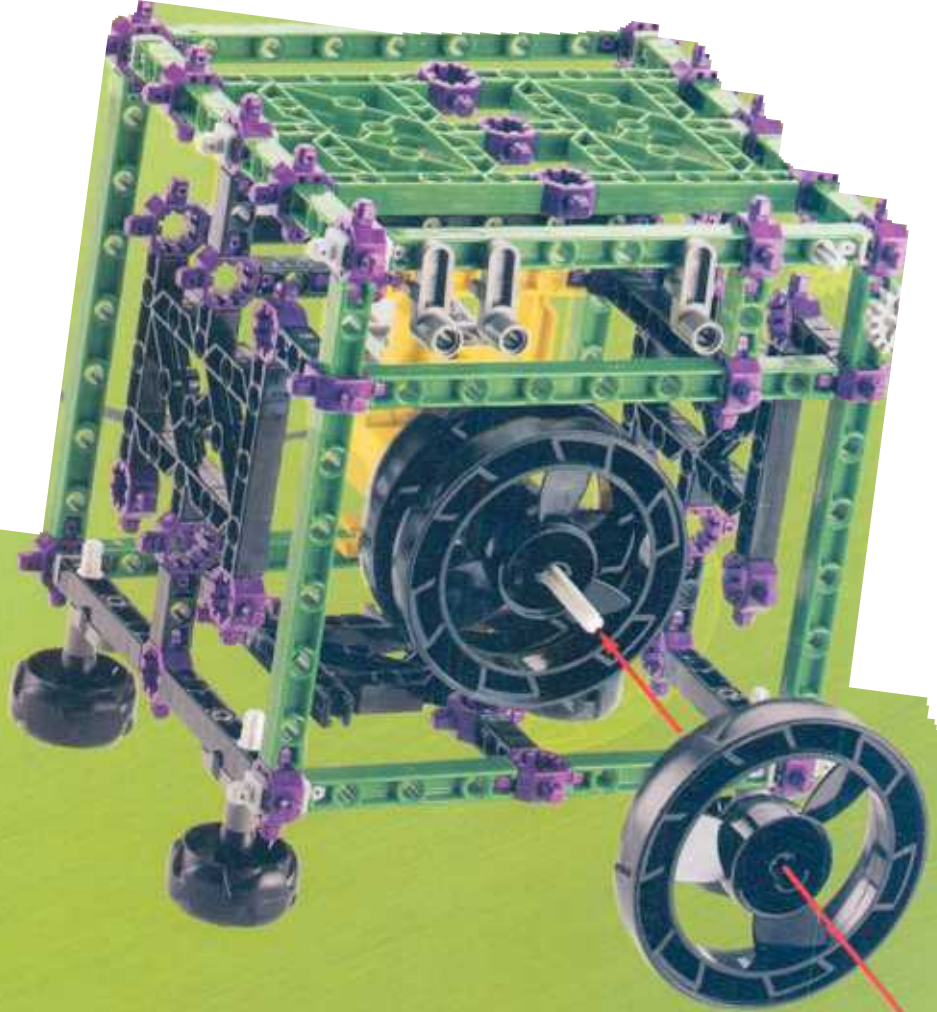

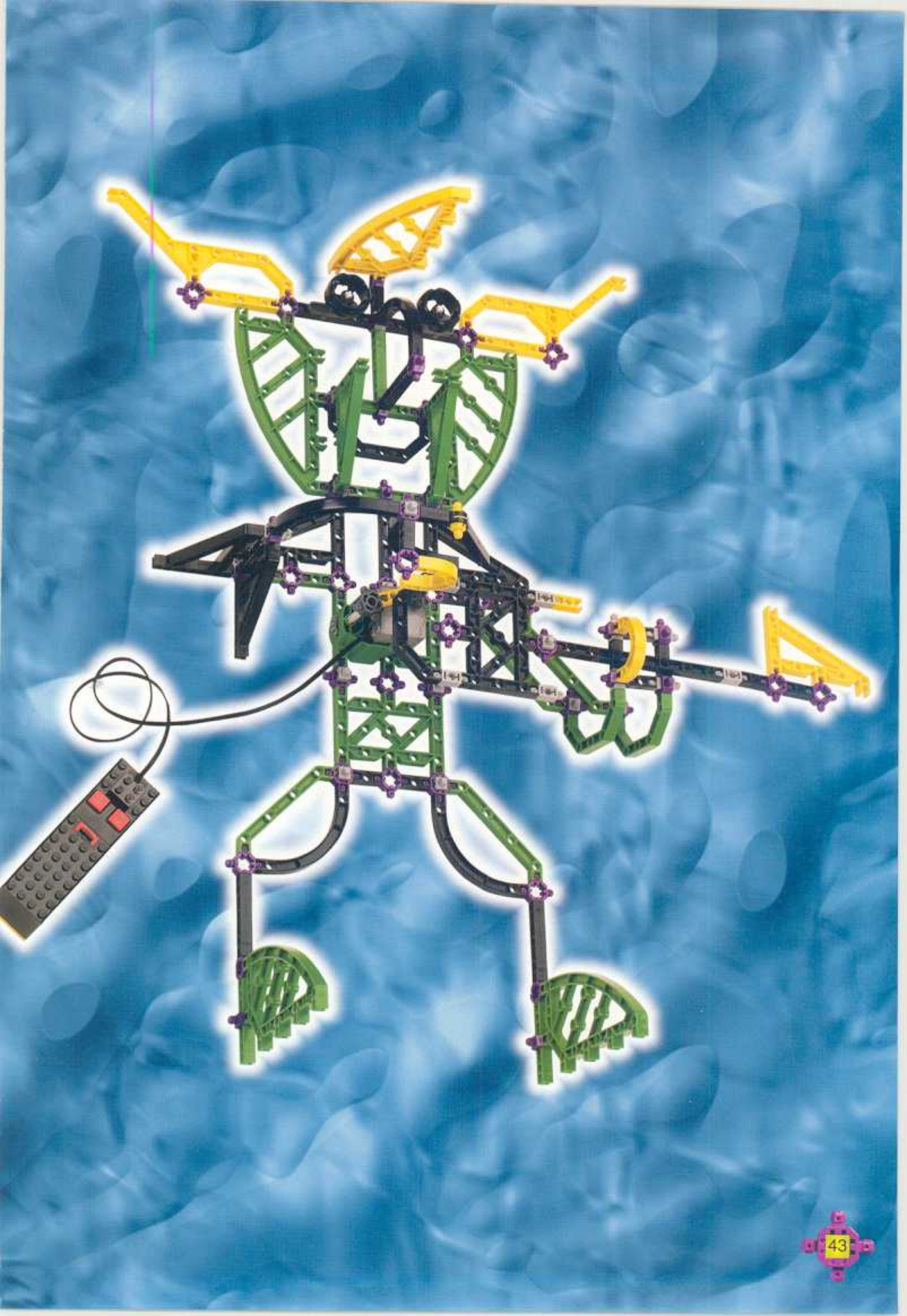

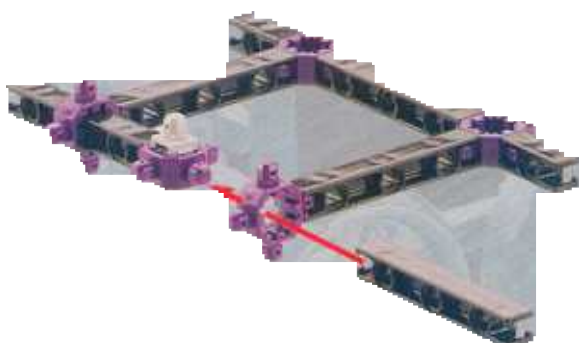
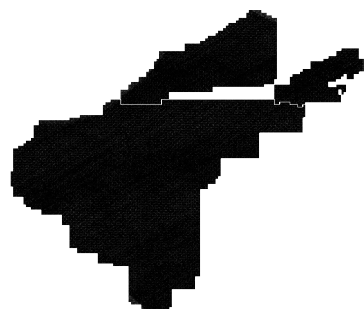
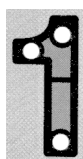
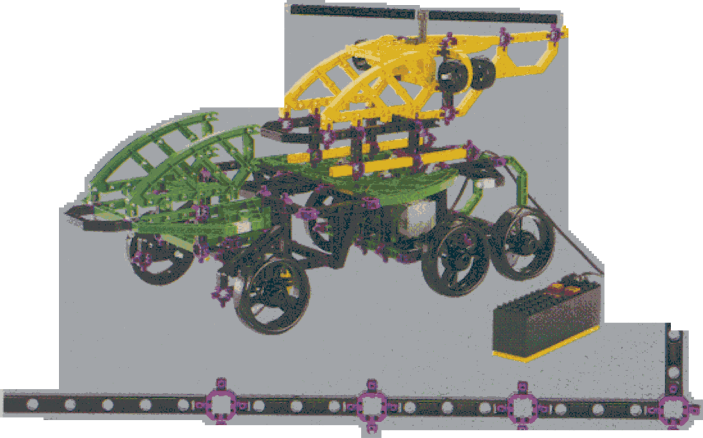

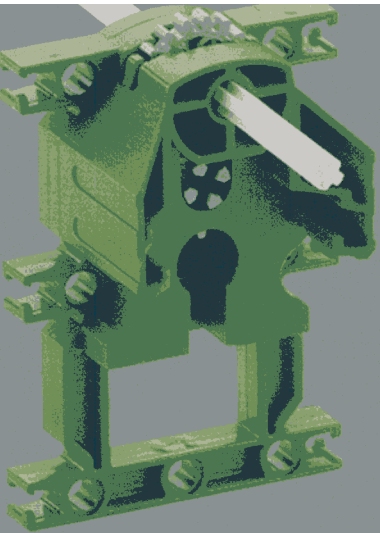

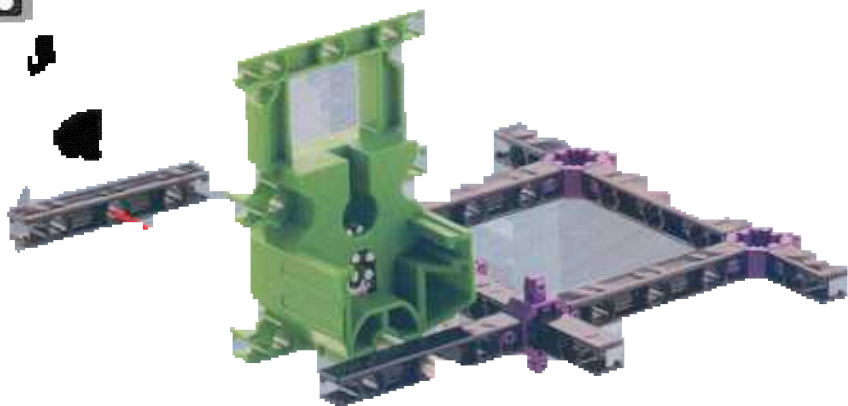

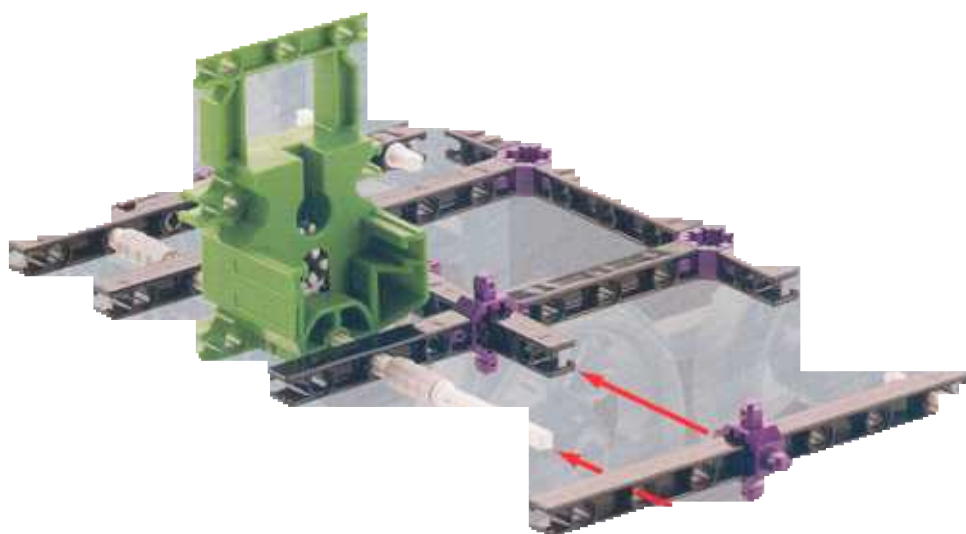

7

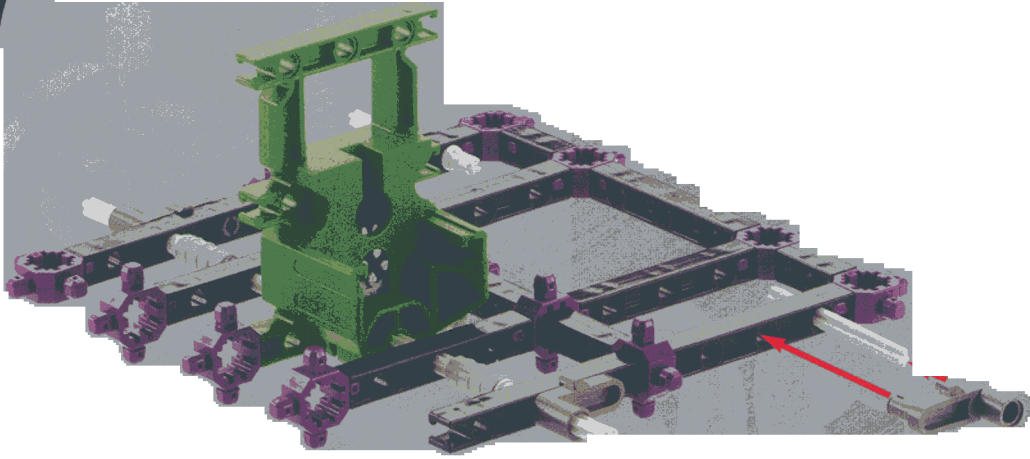

8

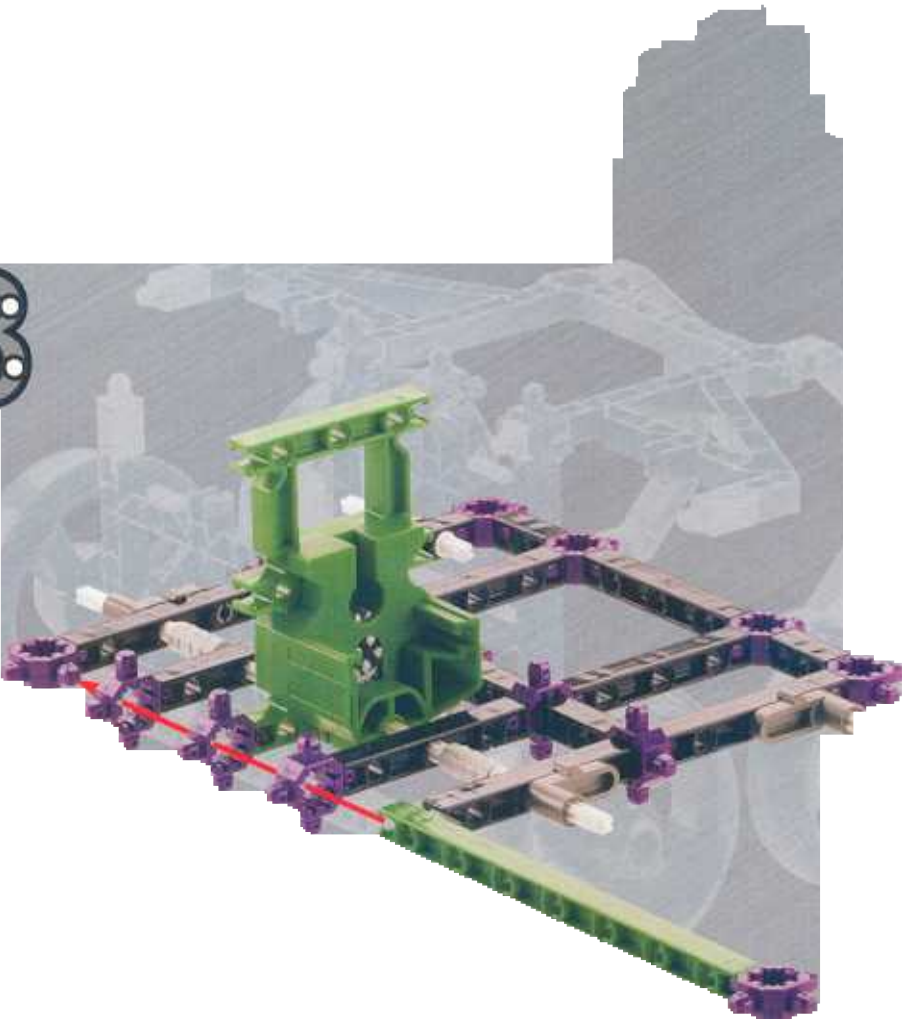

9

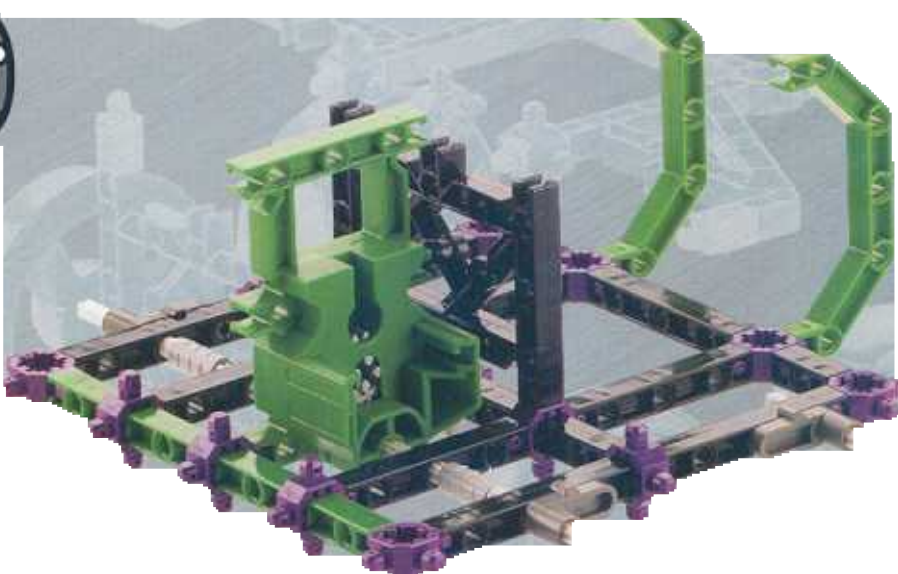

10

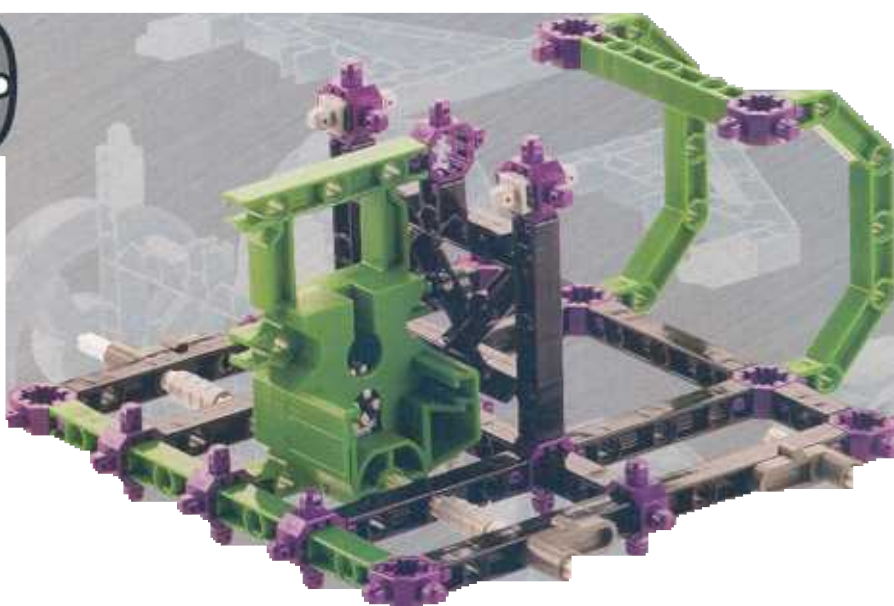

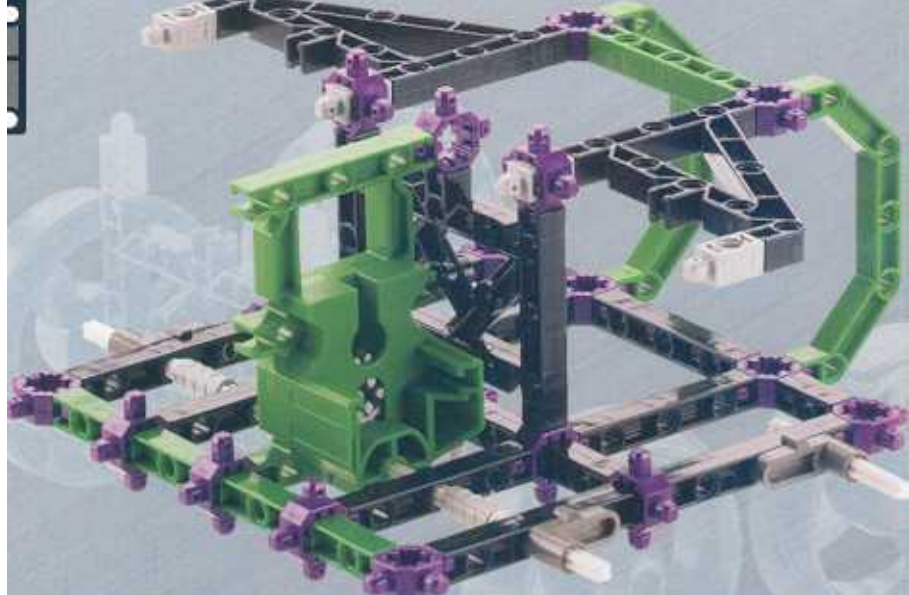

12

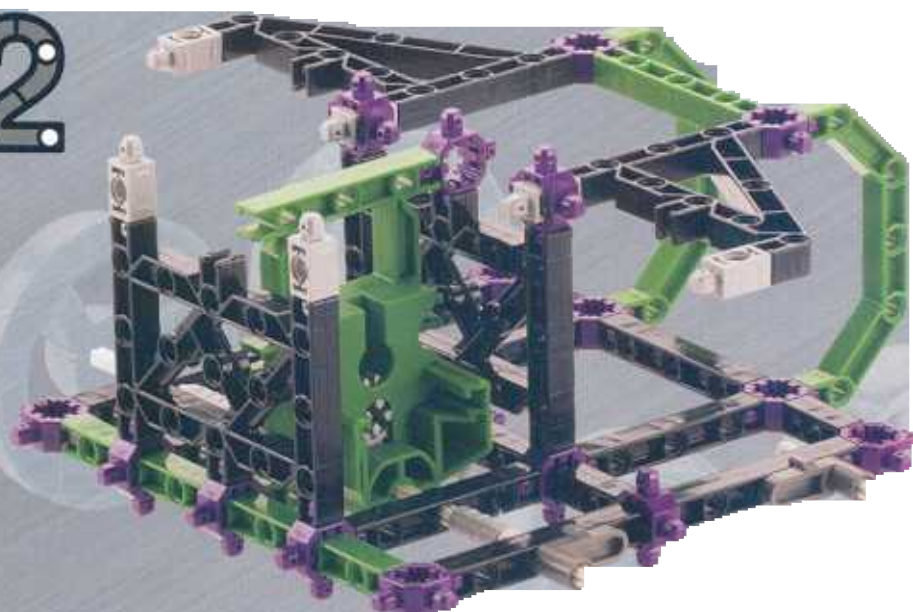

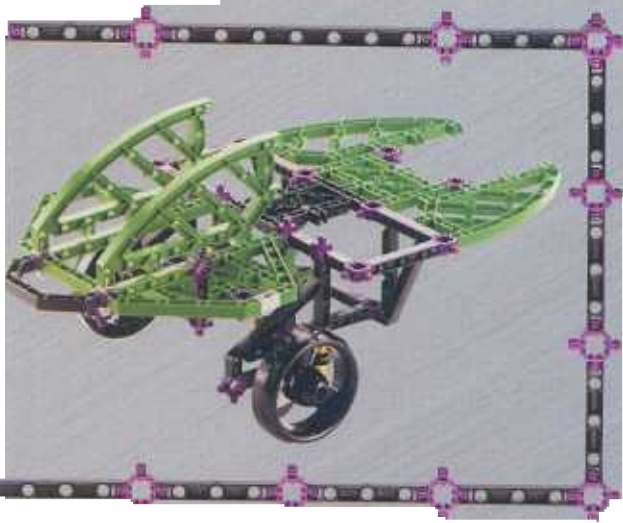
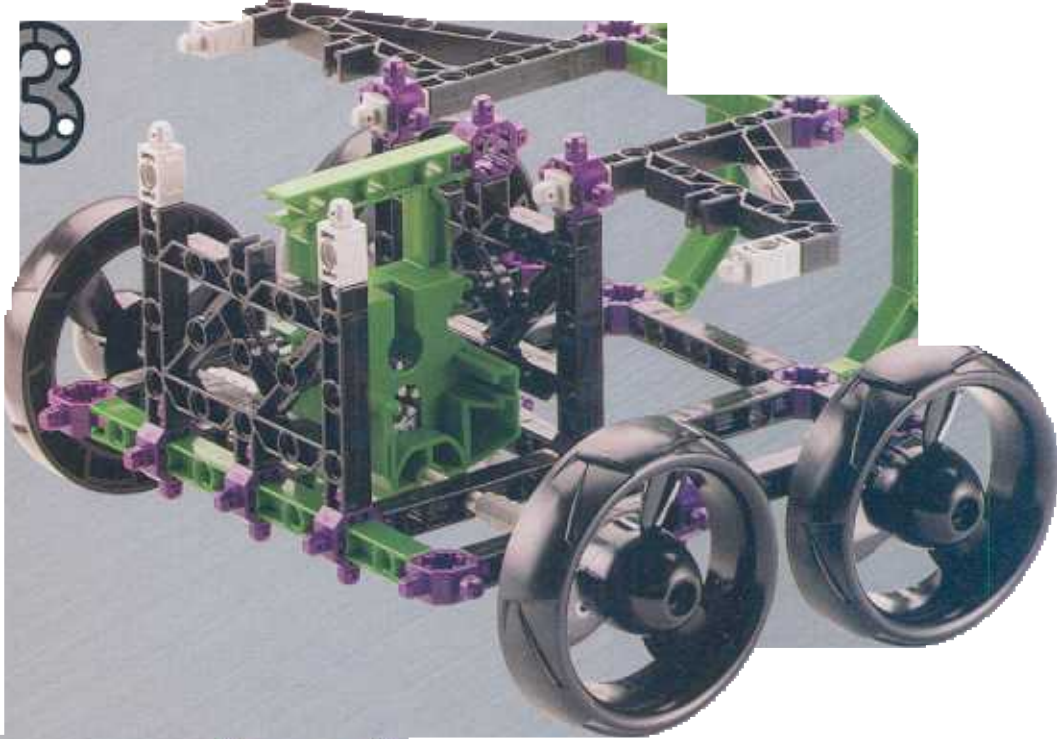

1

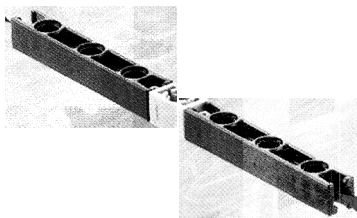

2

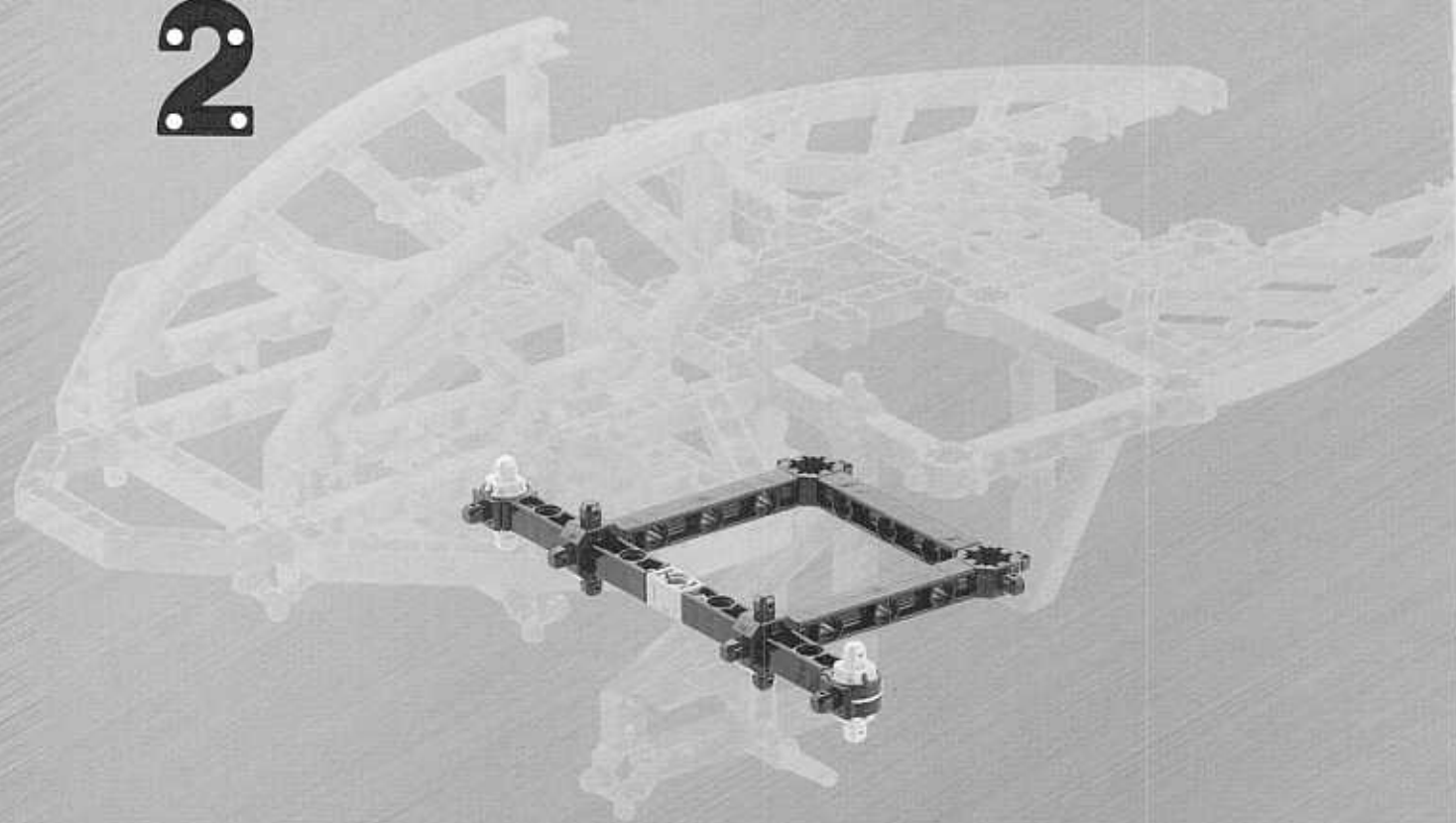

3

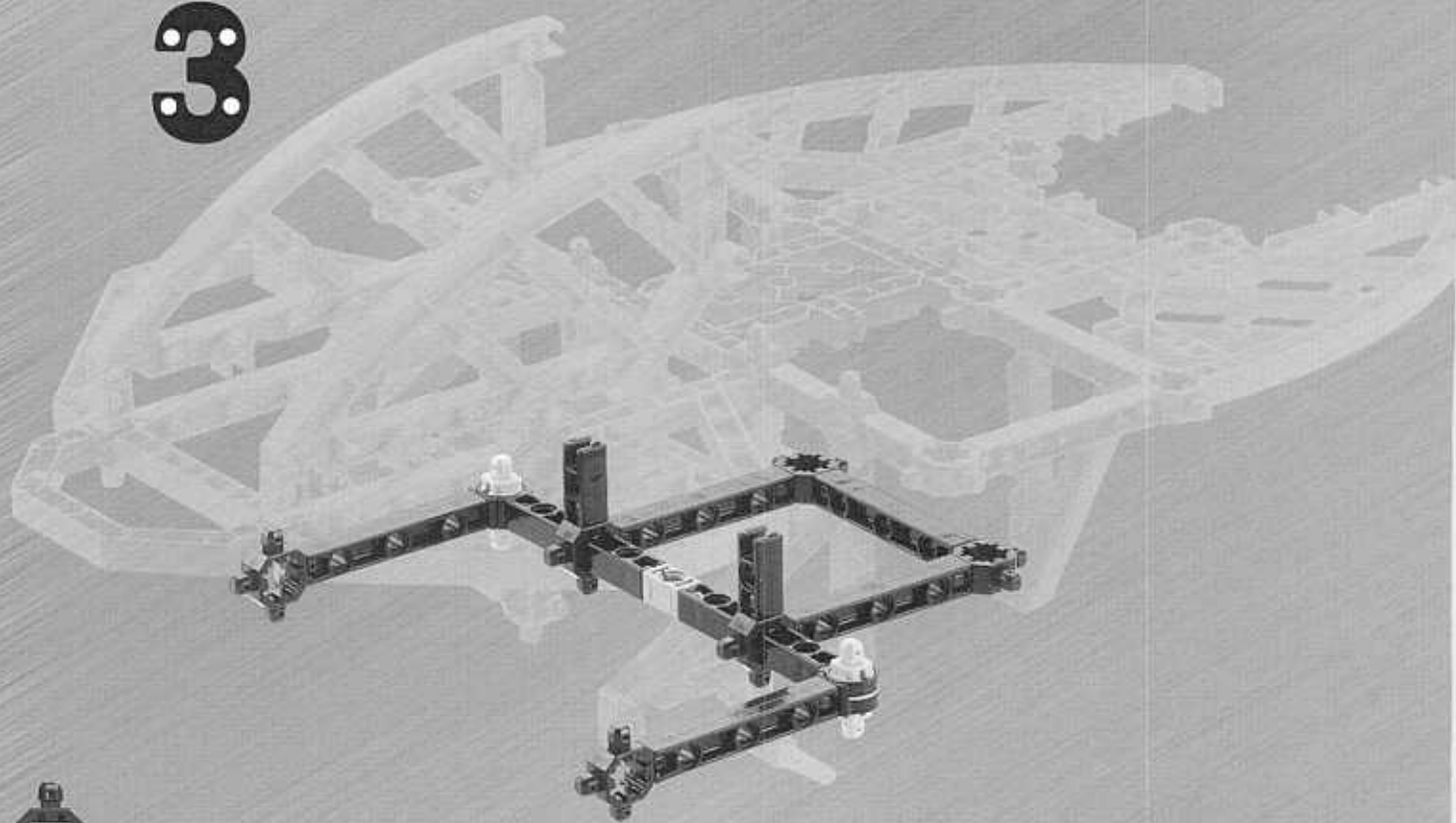

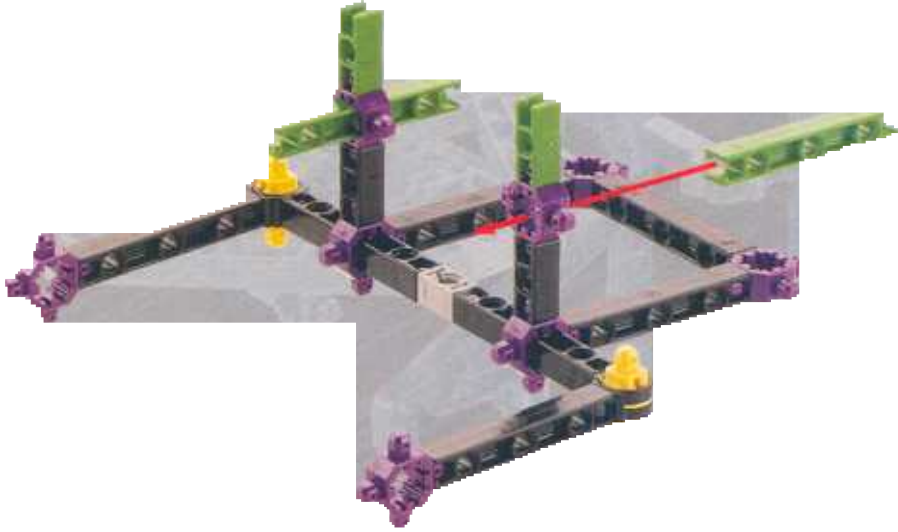

5

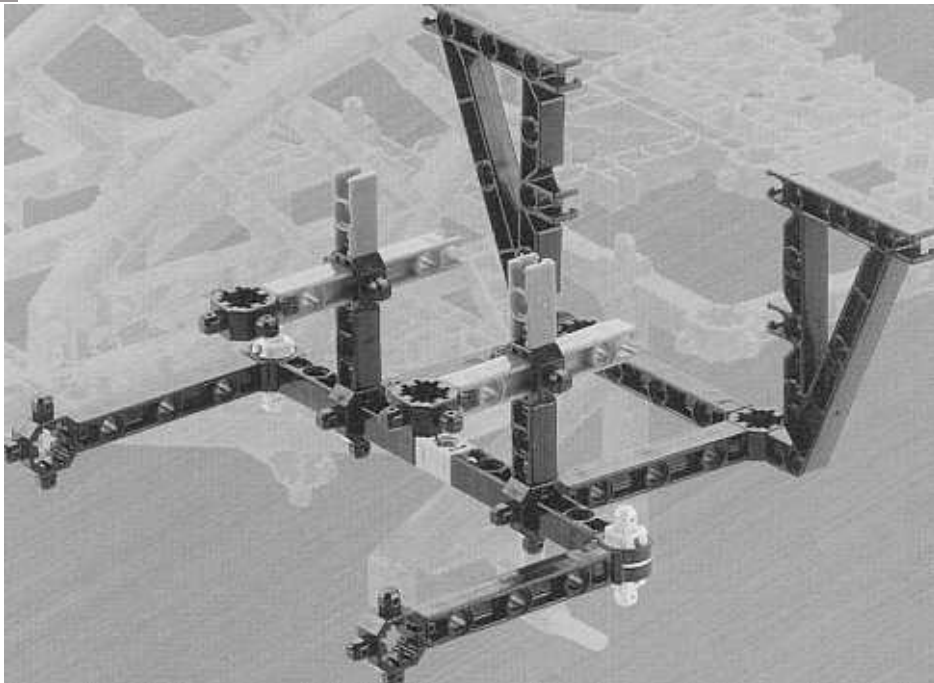

6

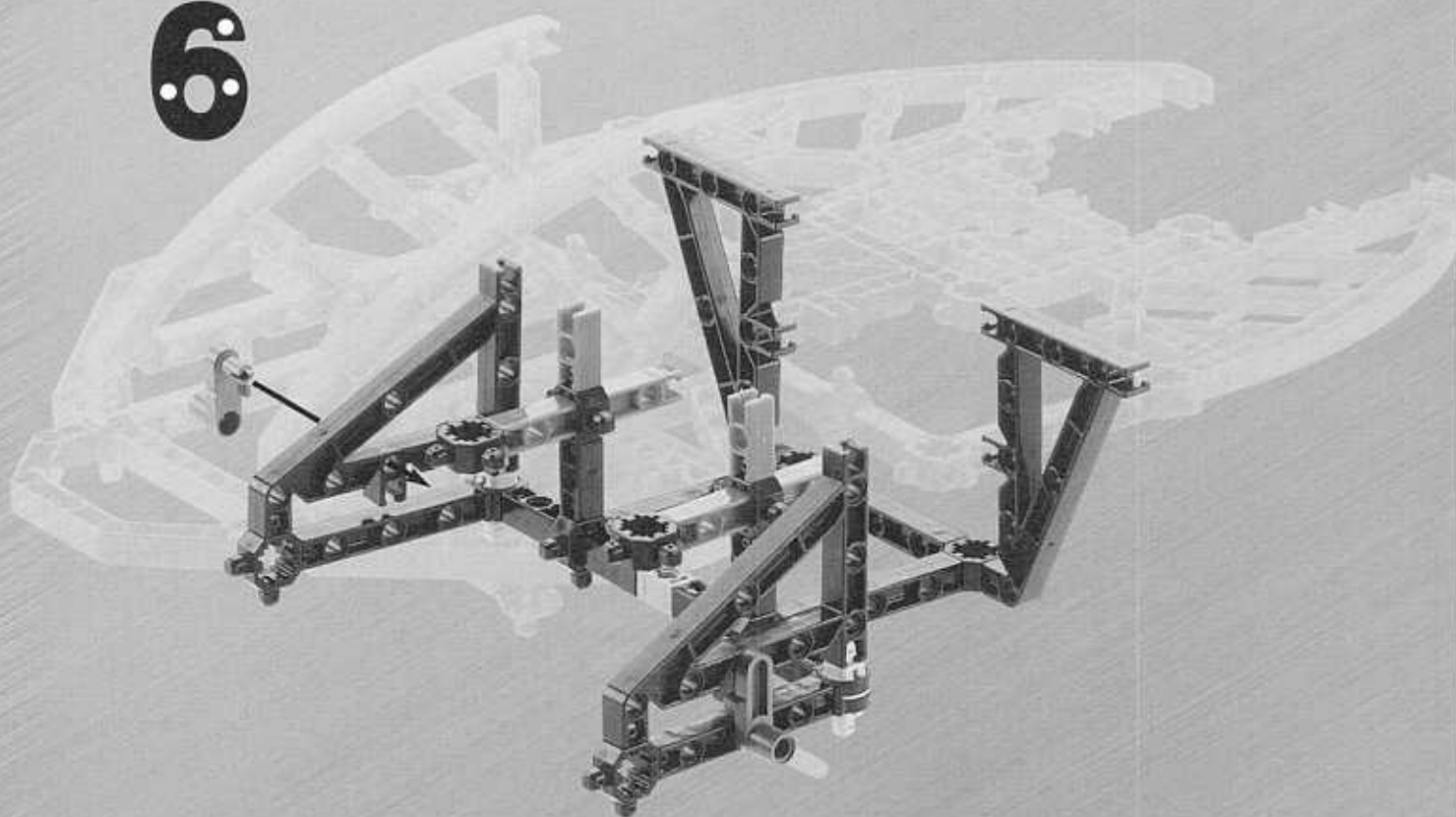

7

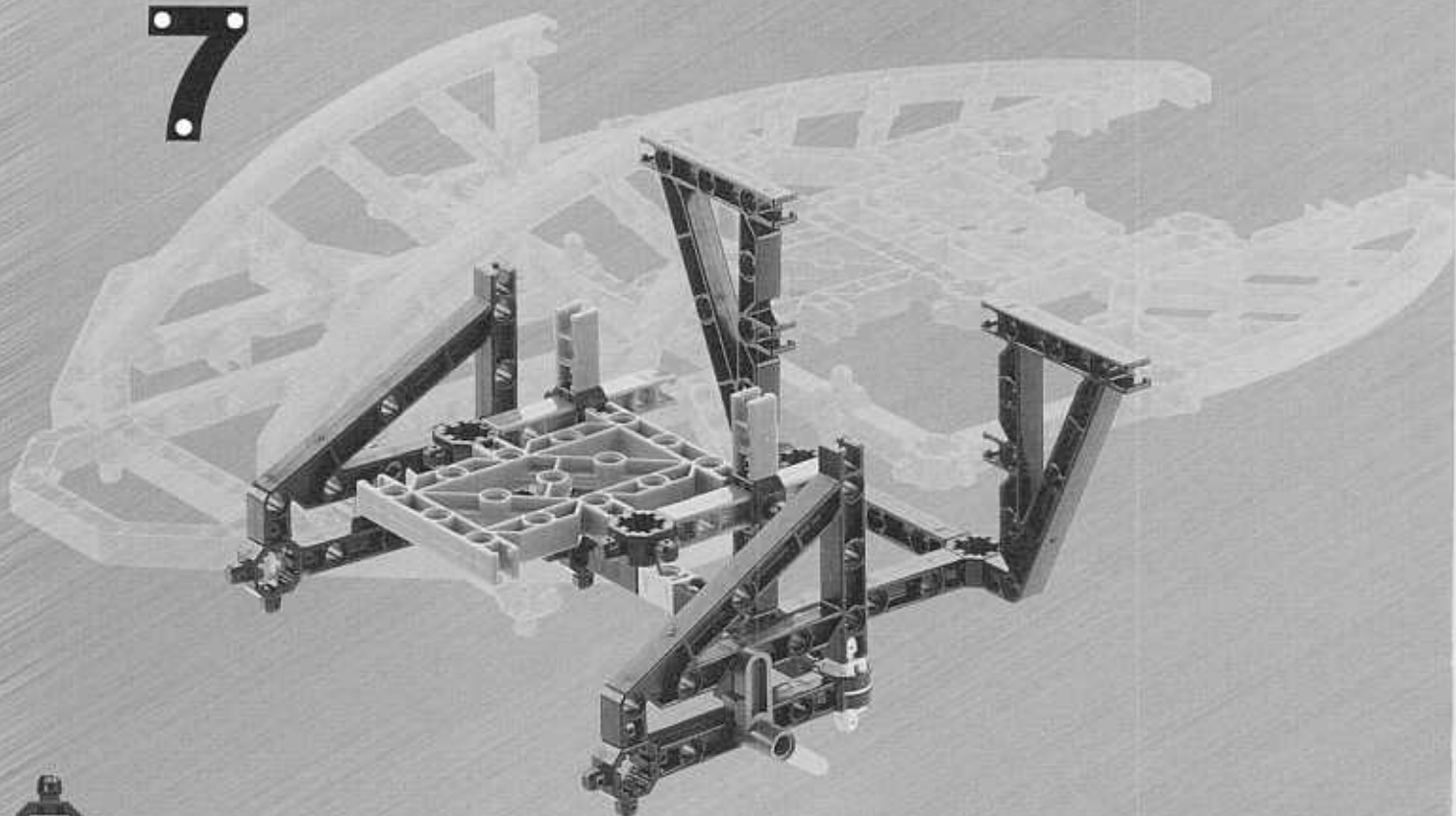

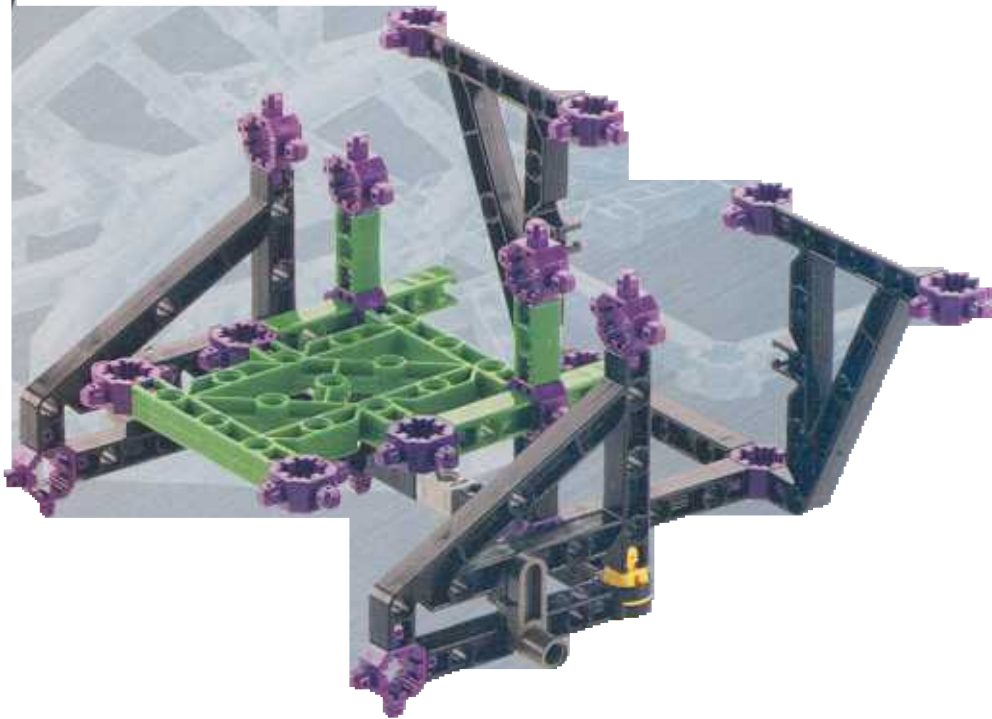

9

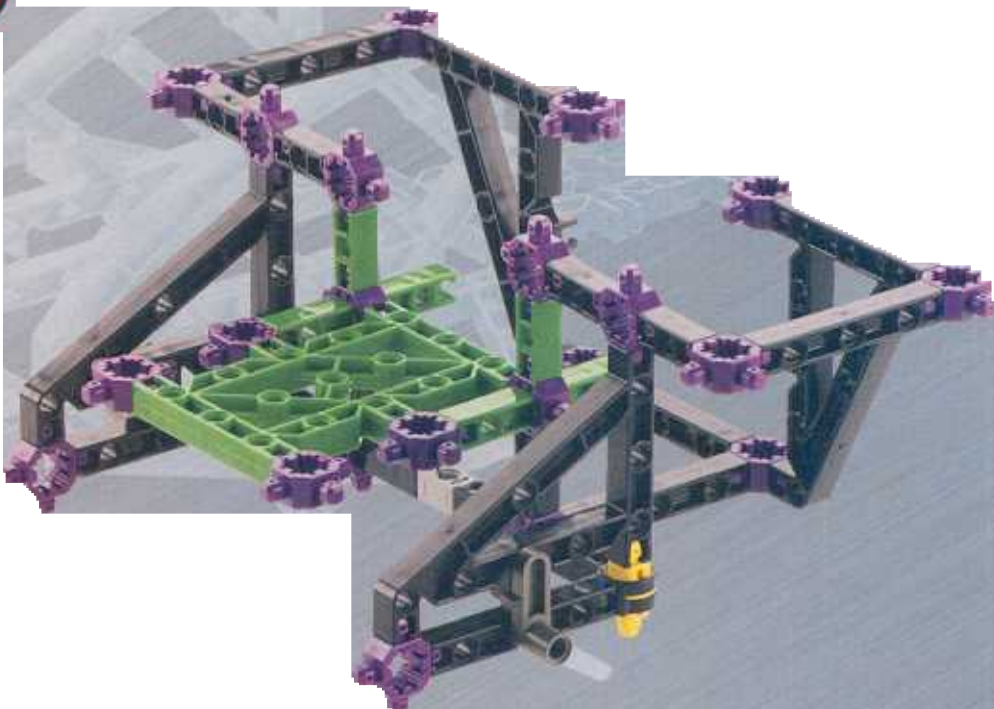

10

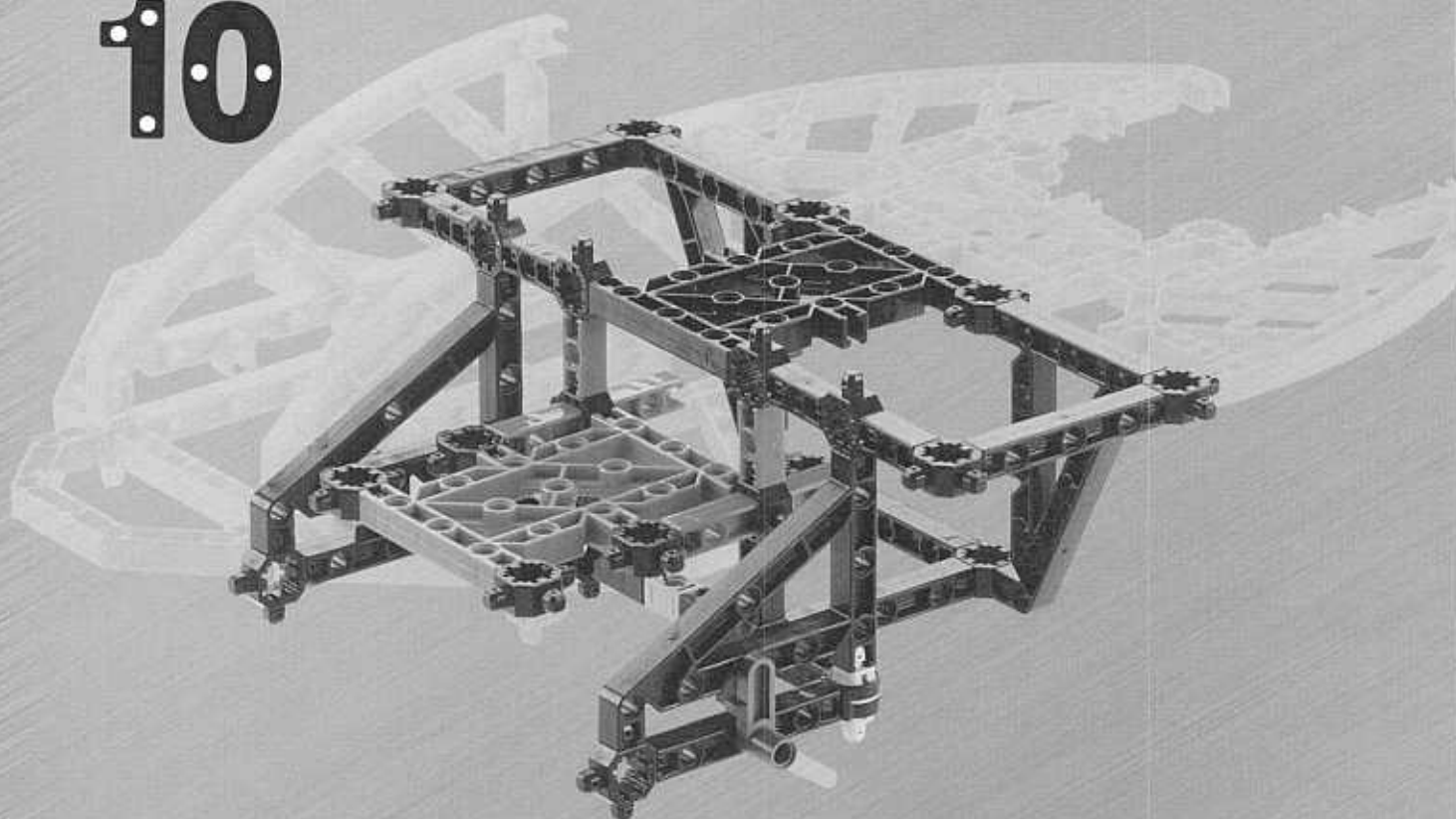

11

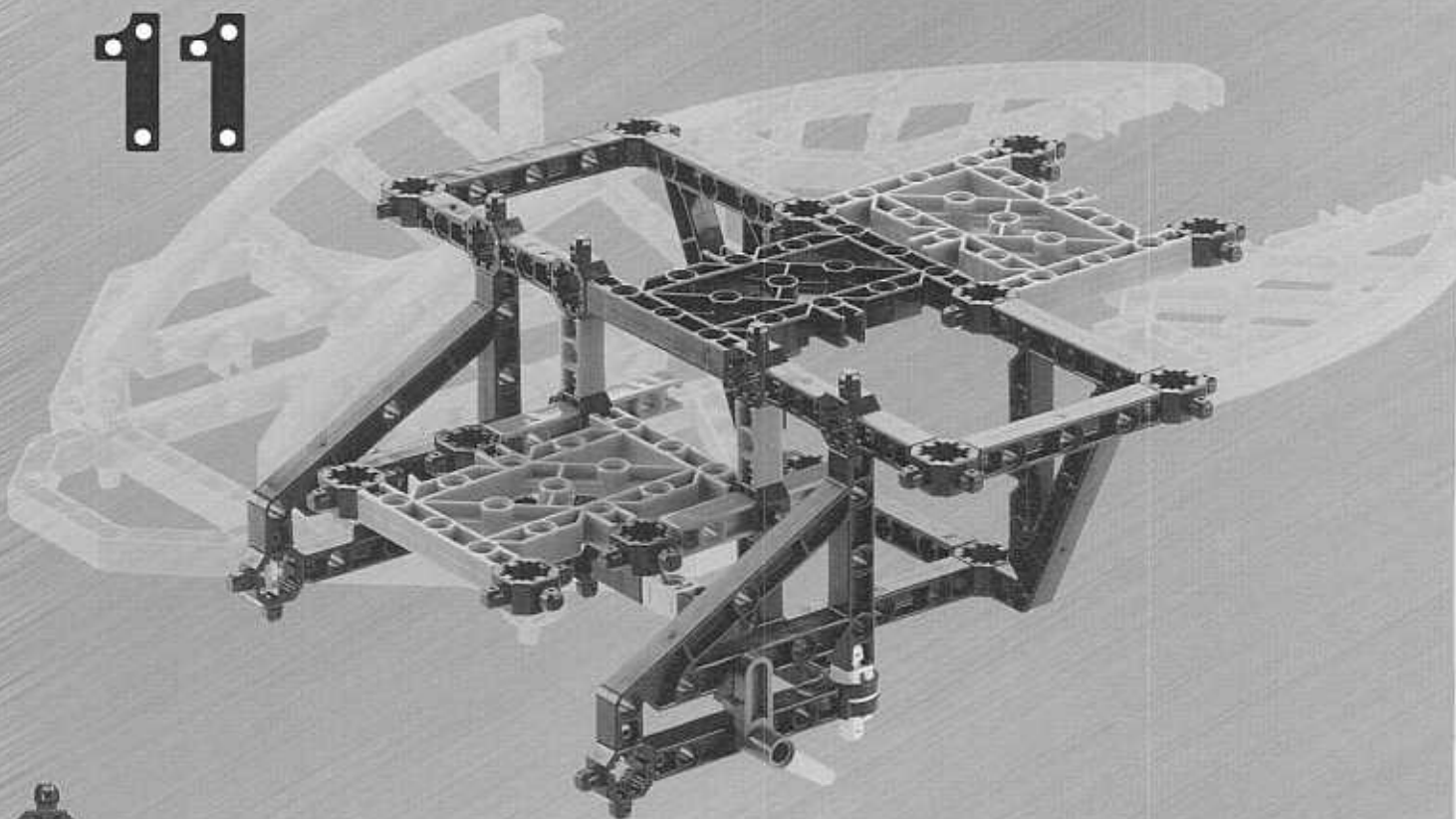

2

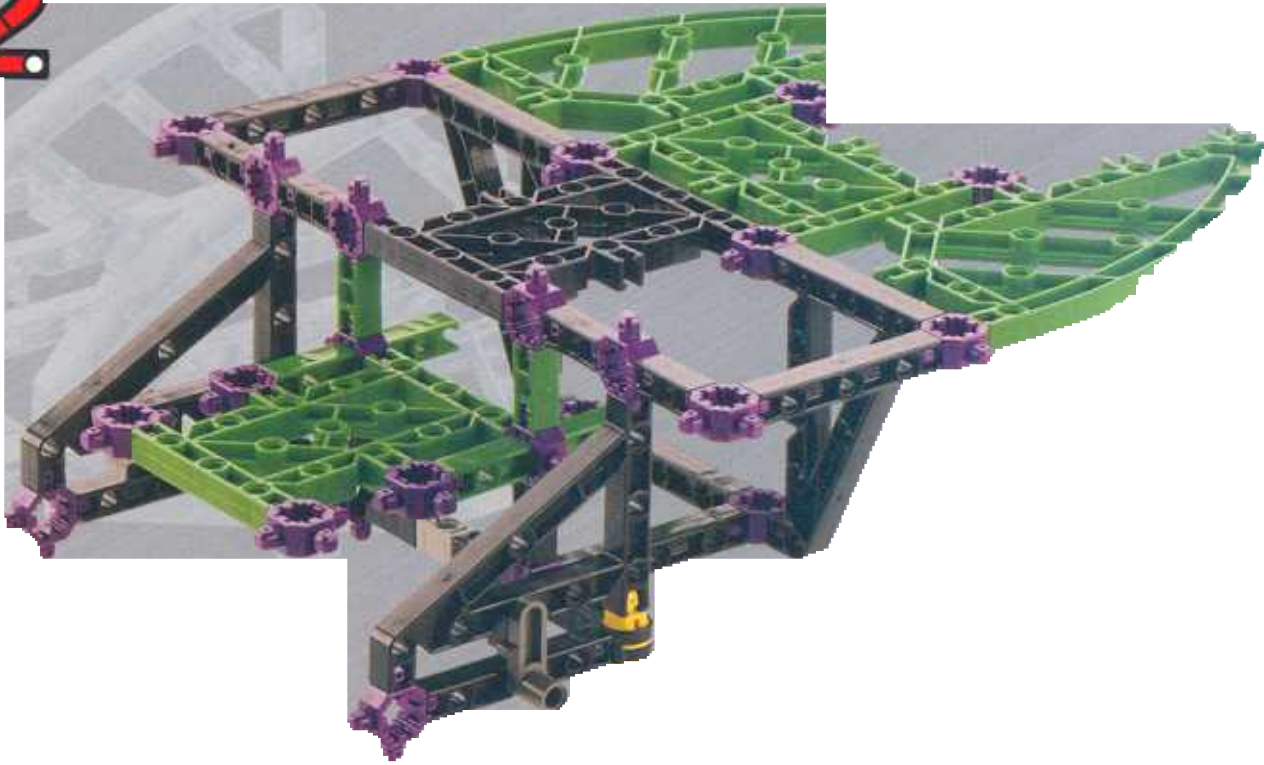

13

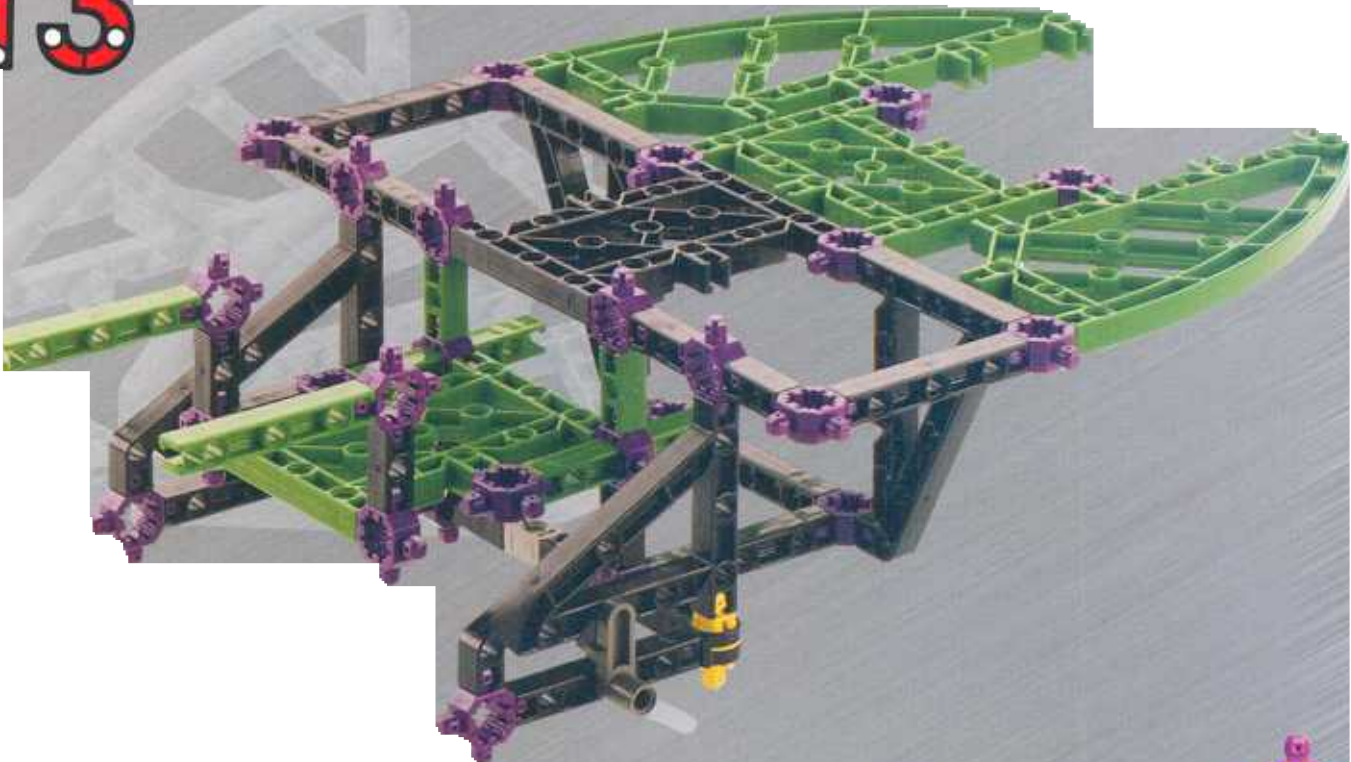

4



15

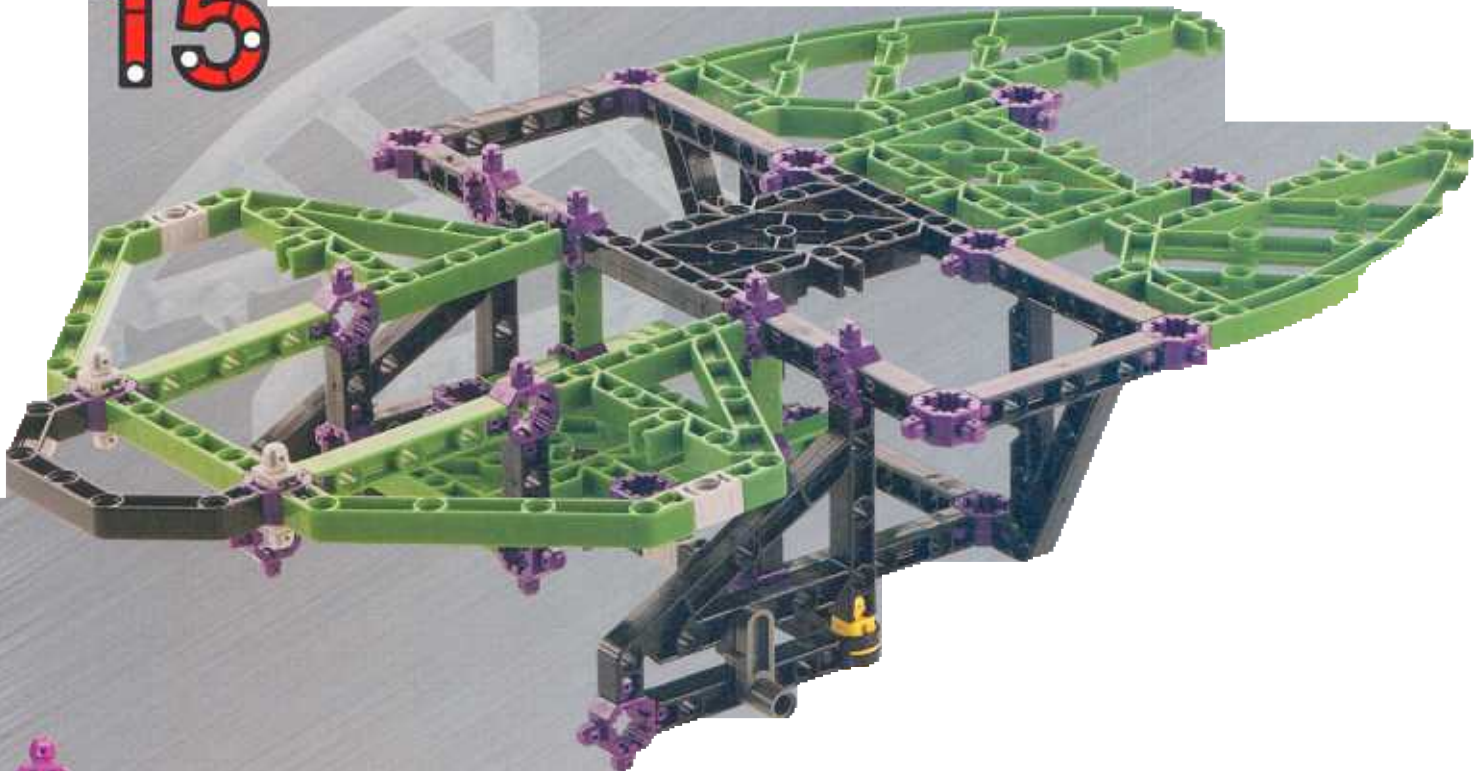

16

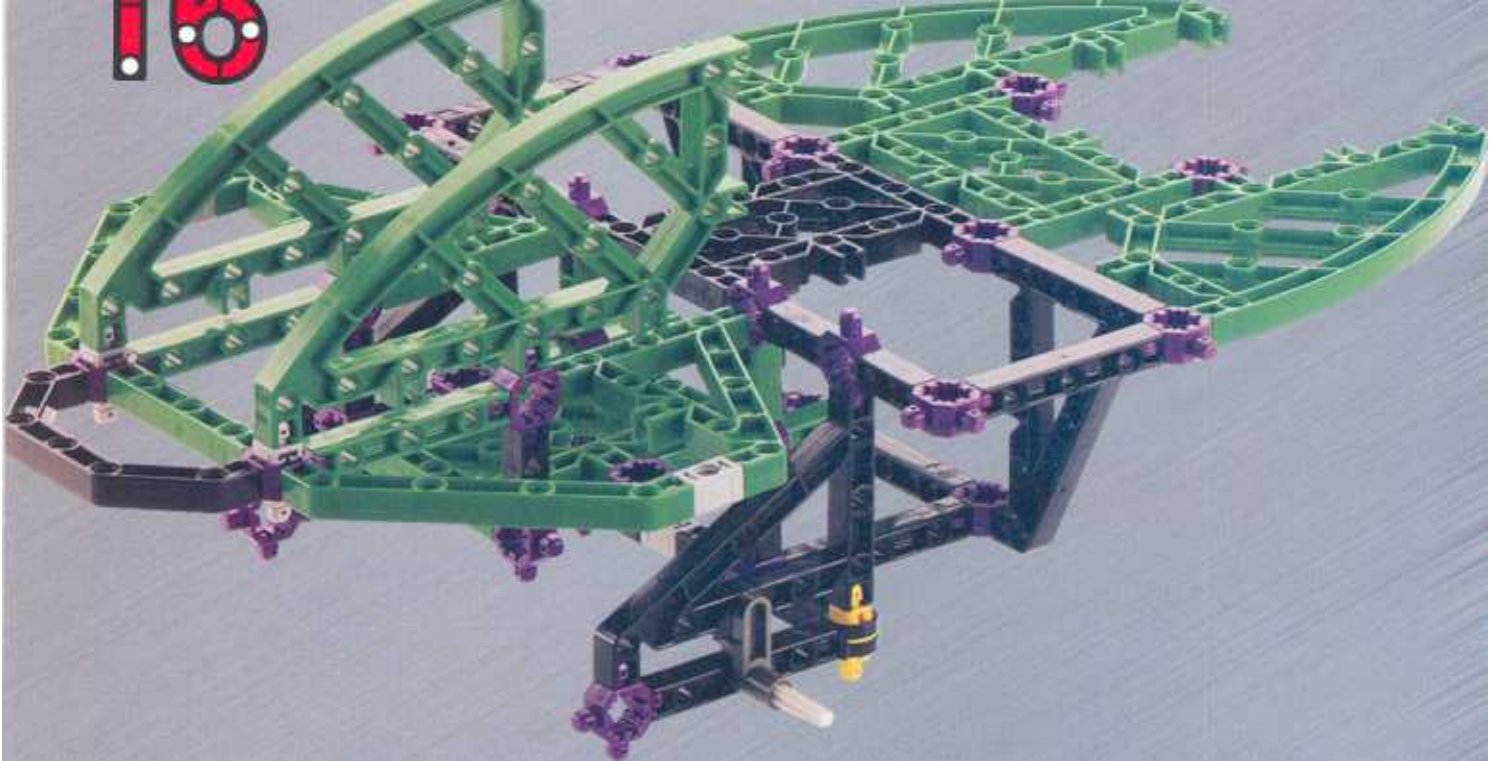

17

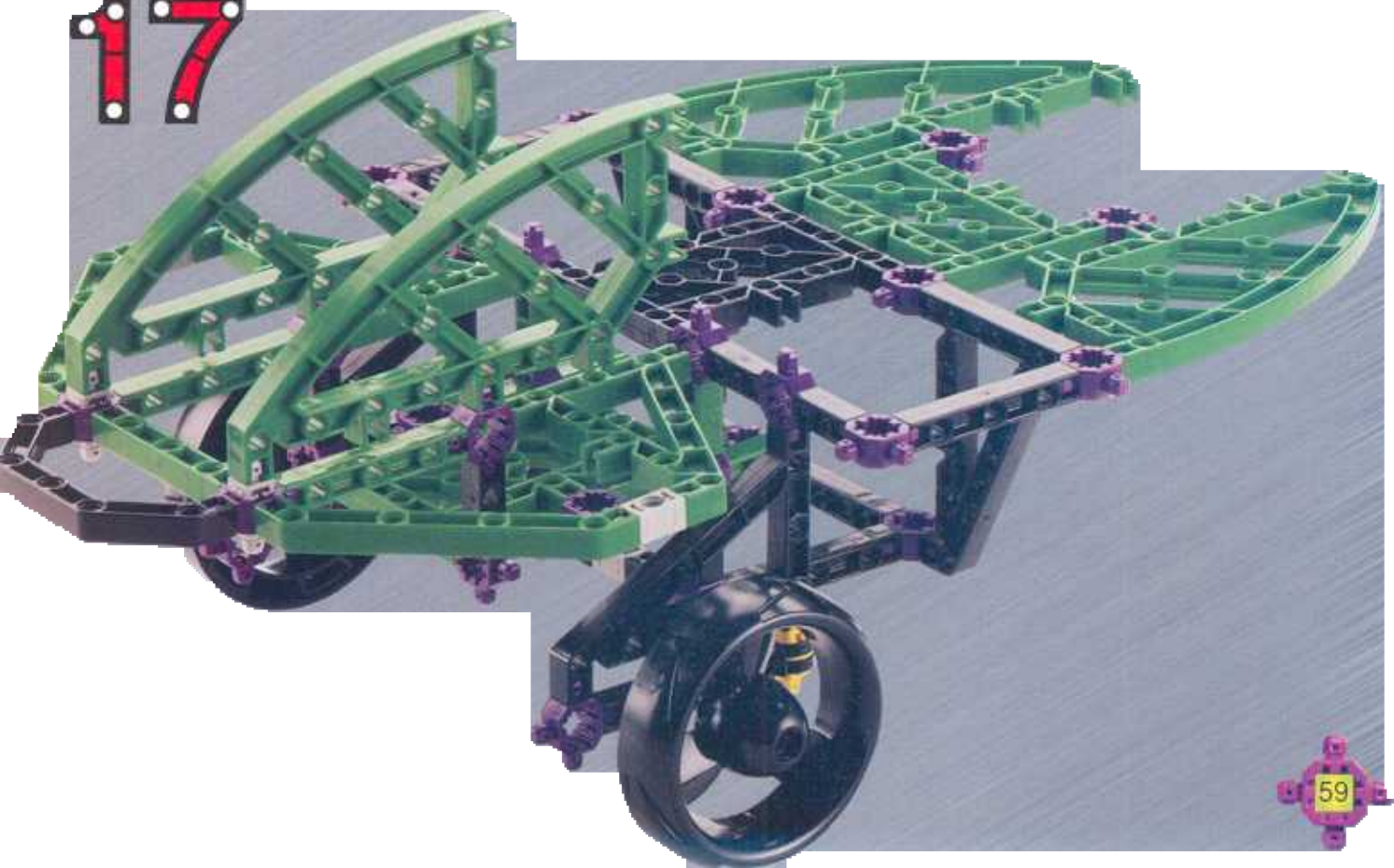

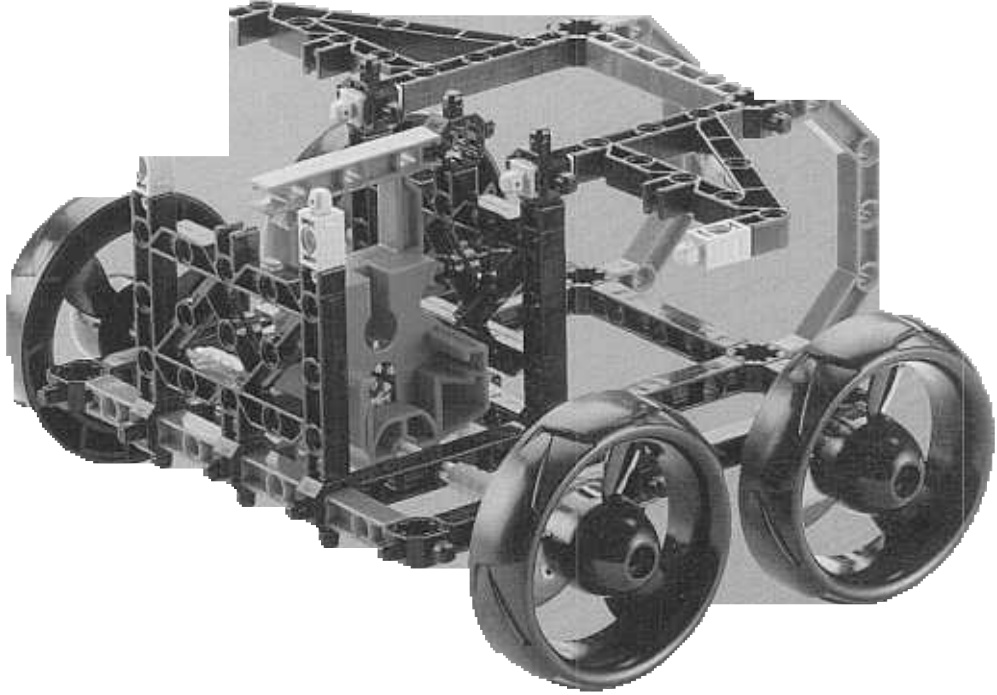

18



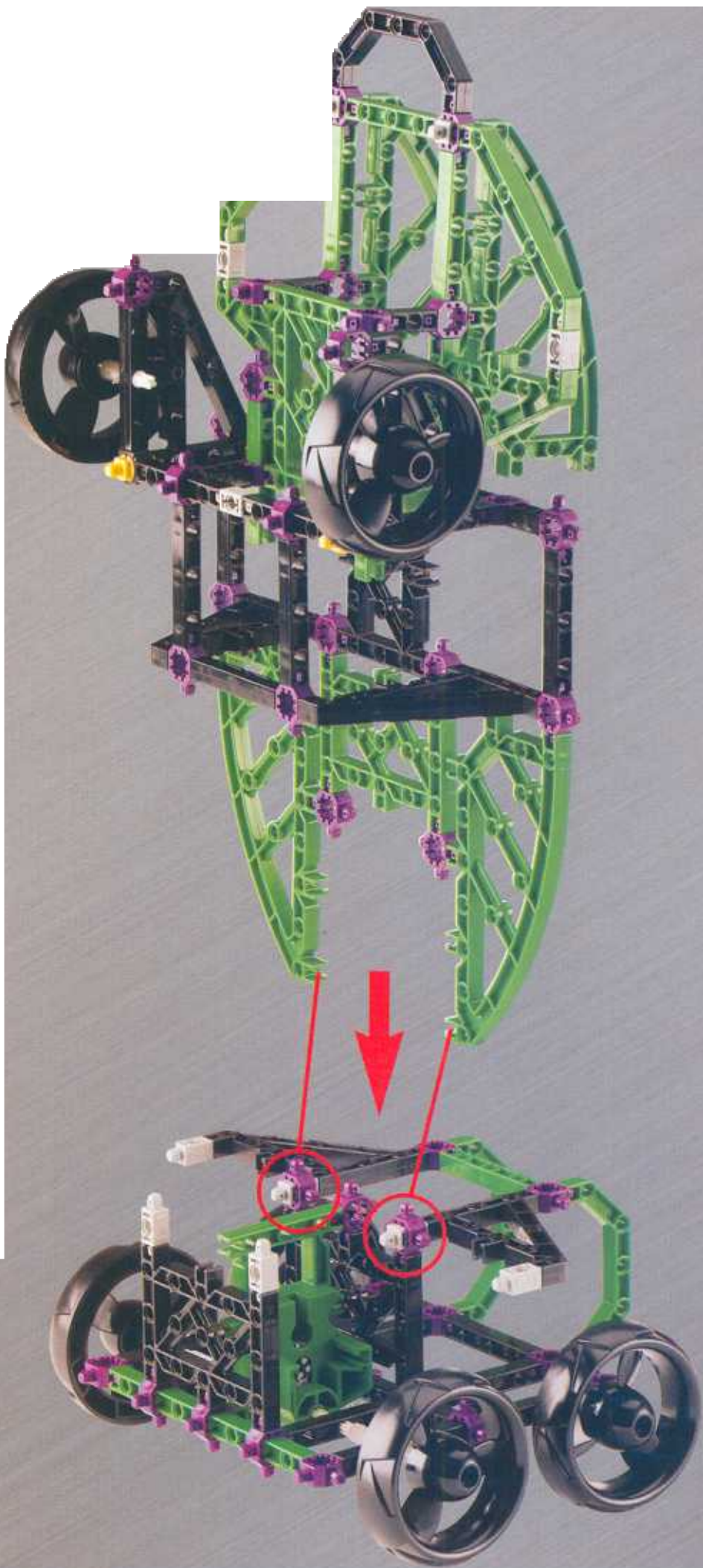

19

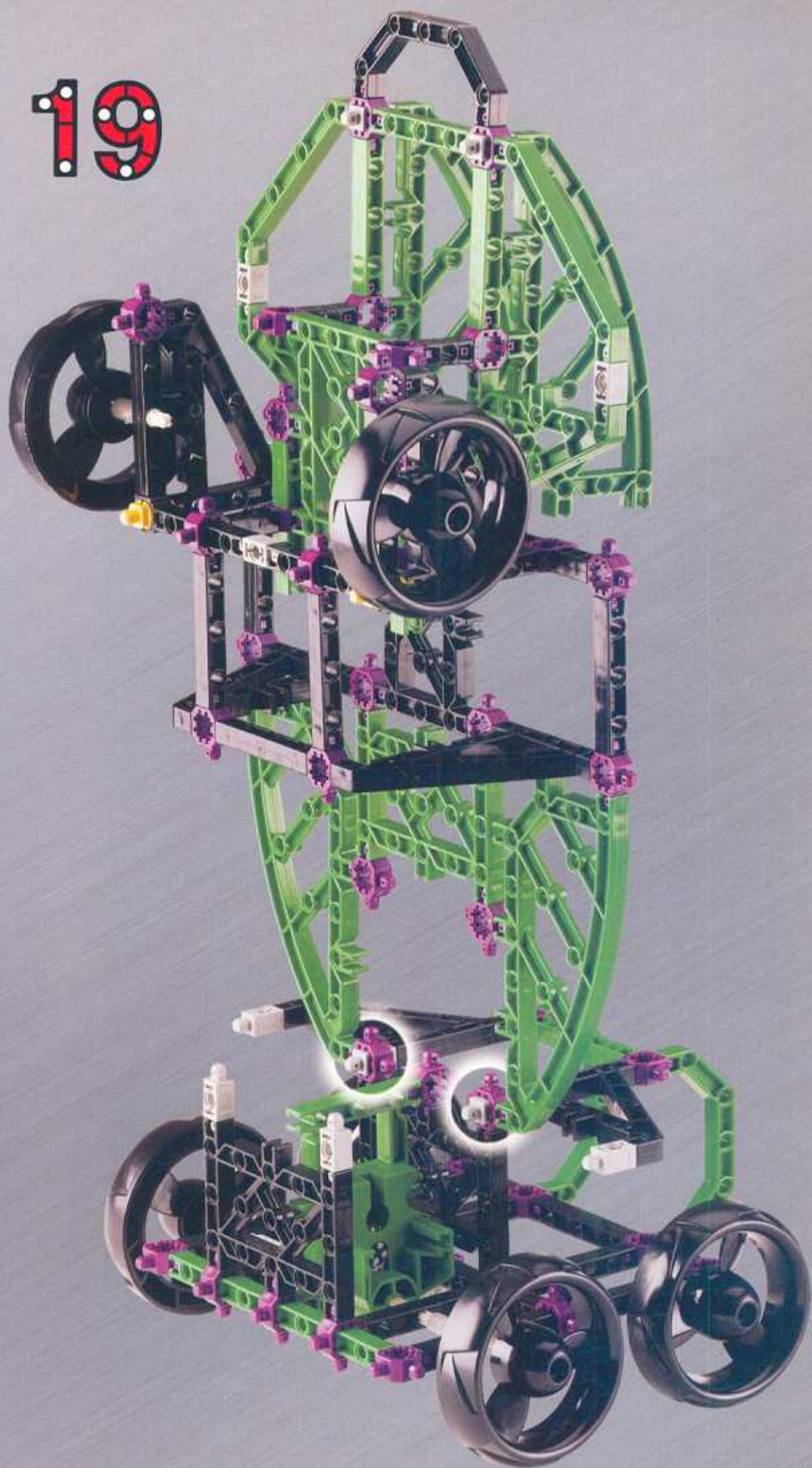



21



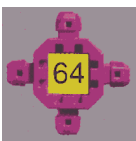
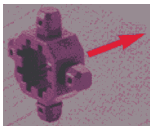
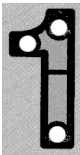
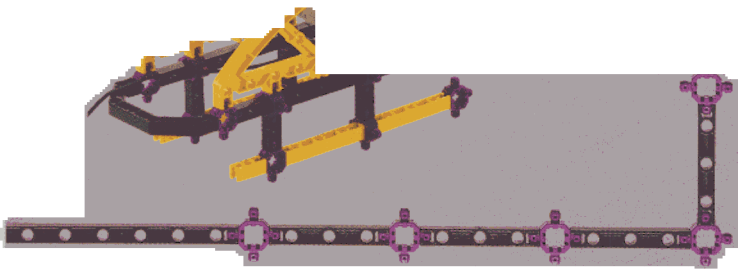

2



3



4

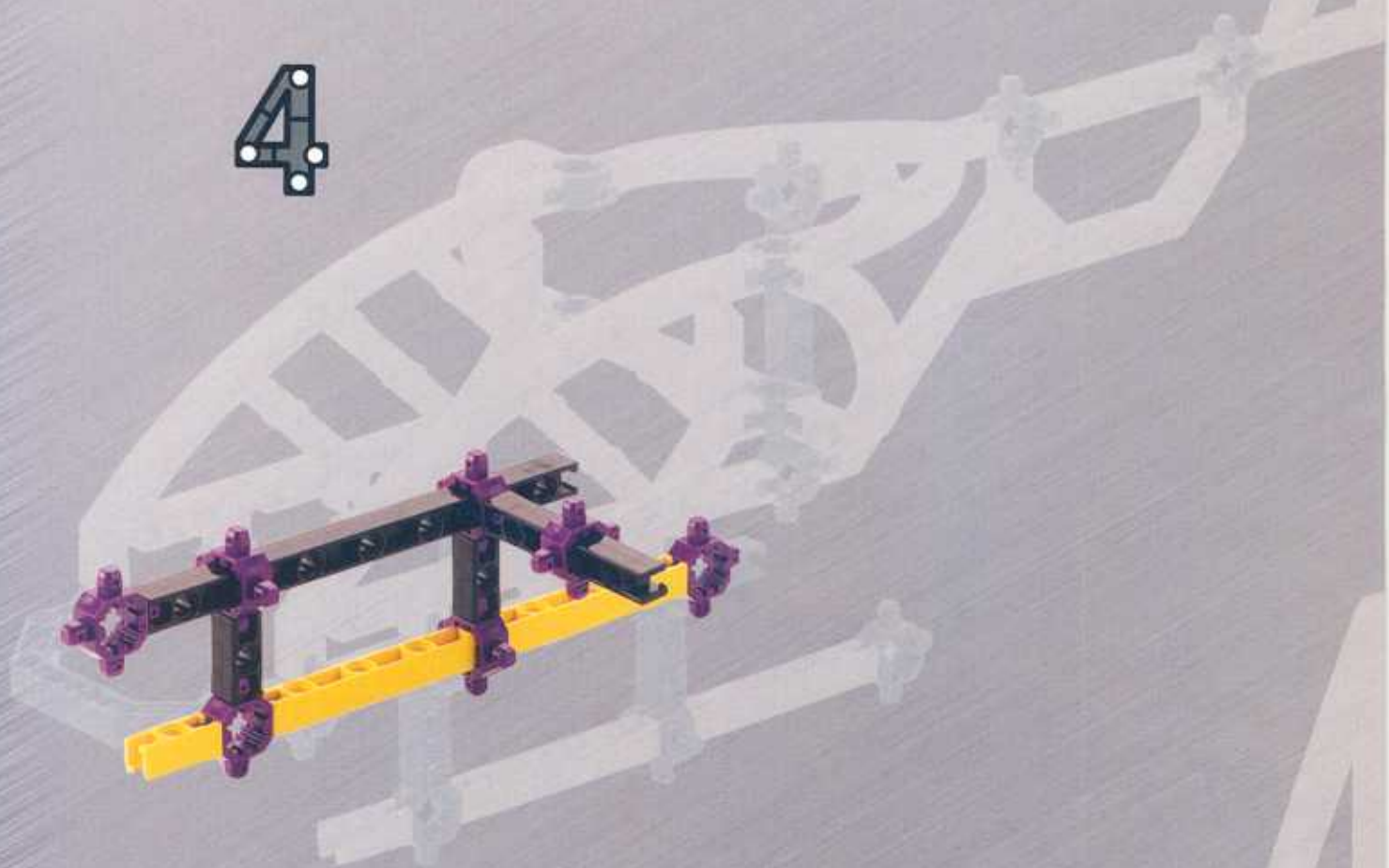

5

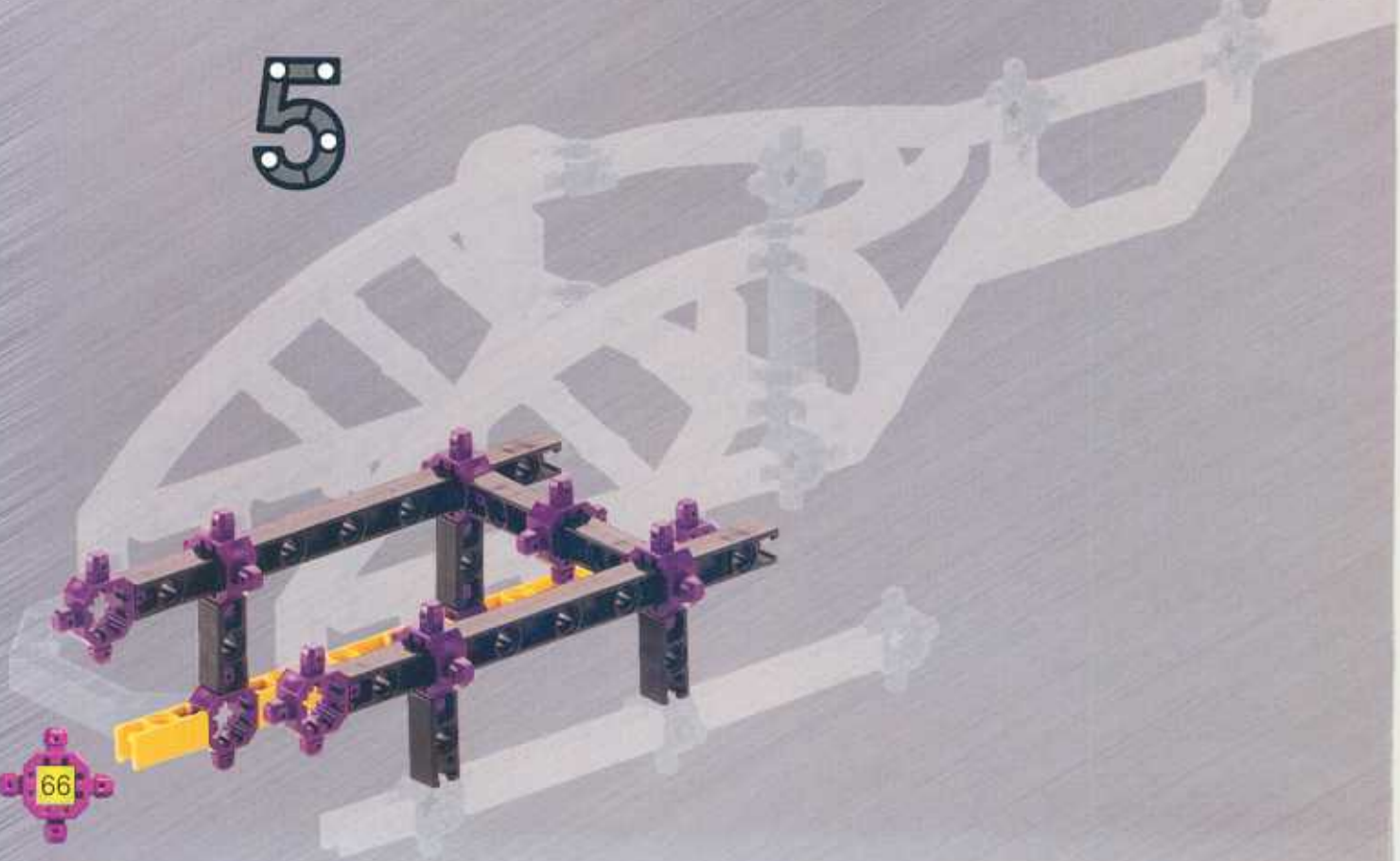

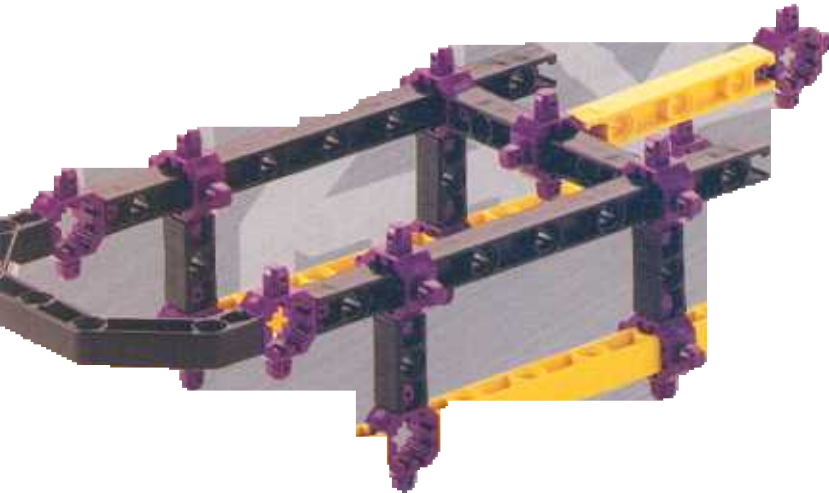
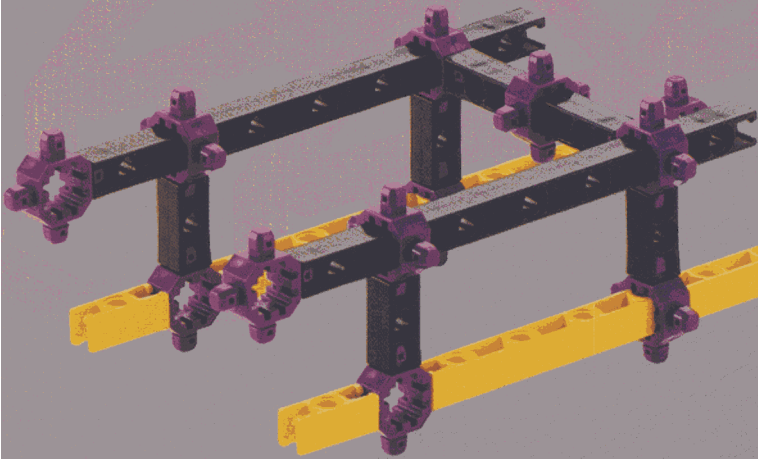

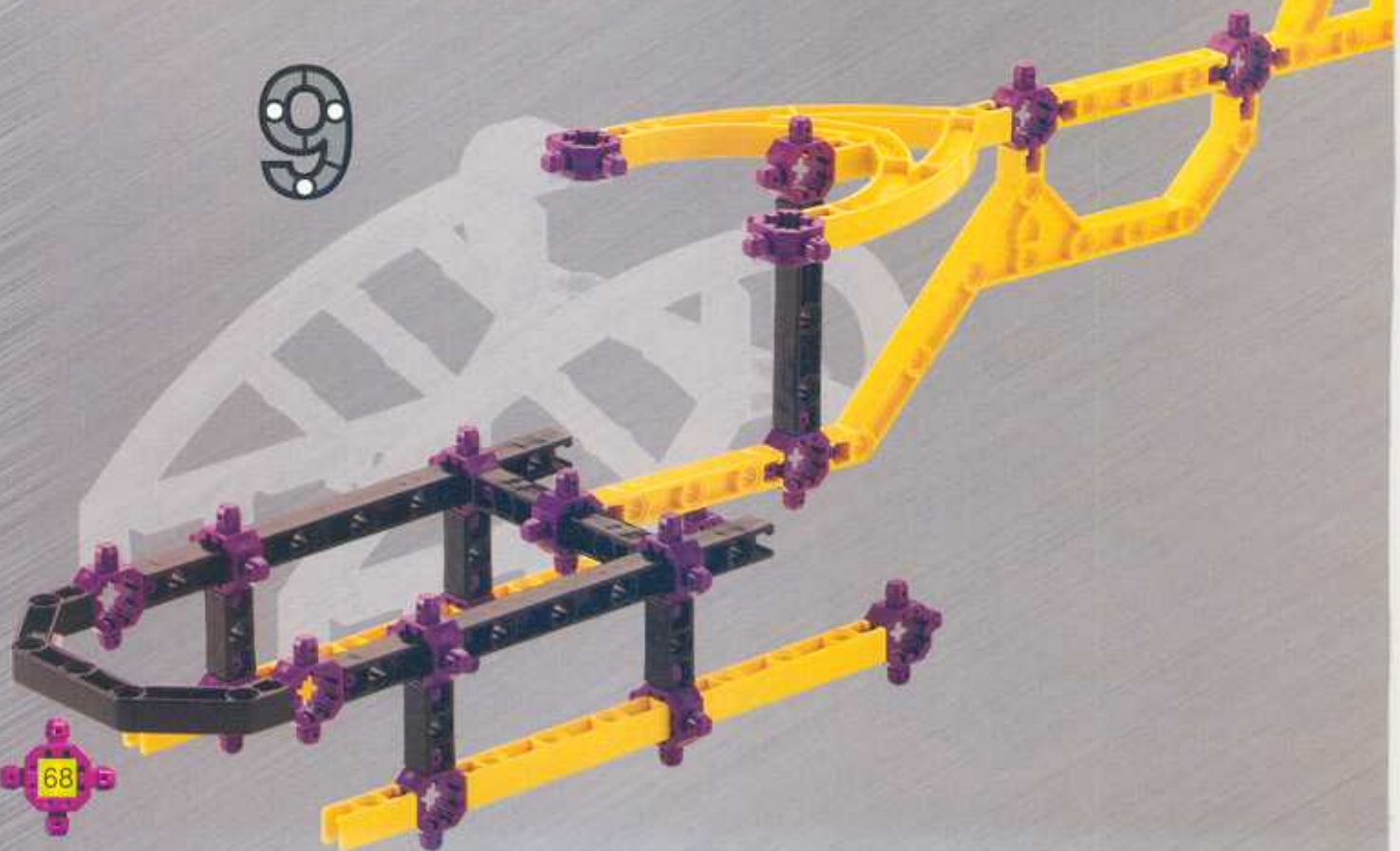
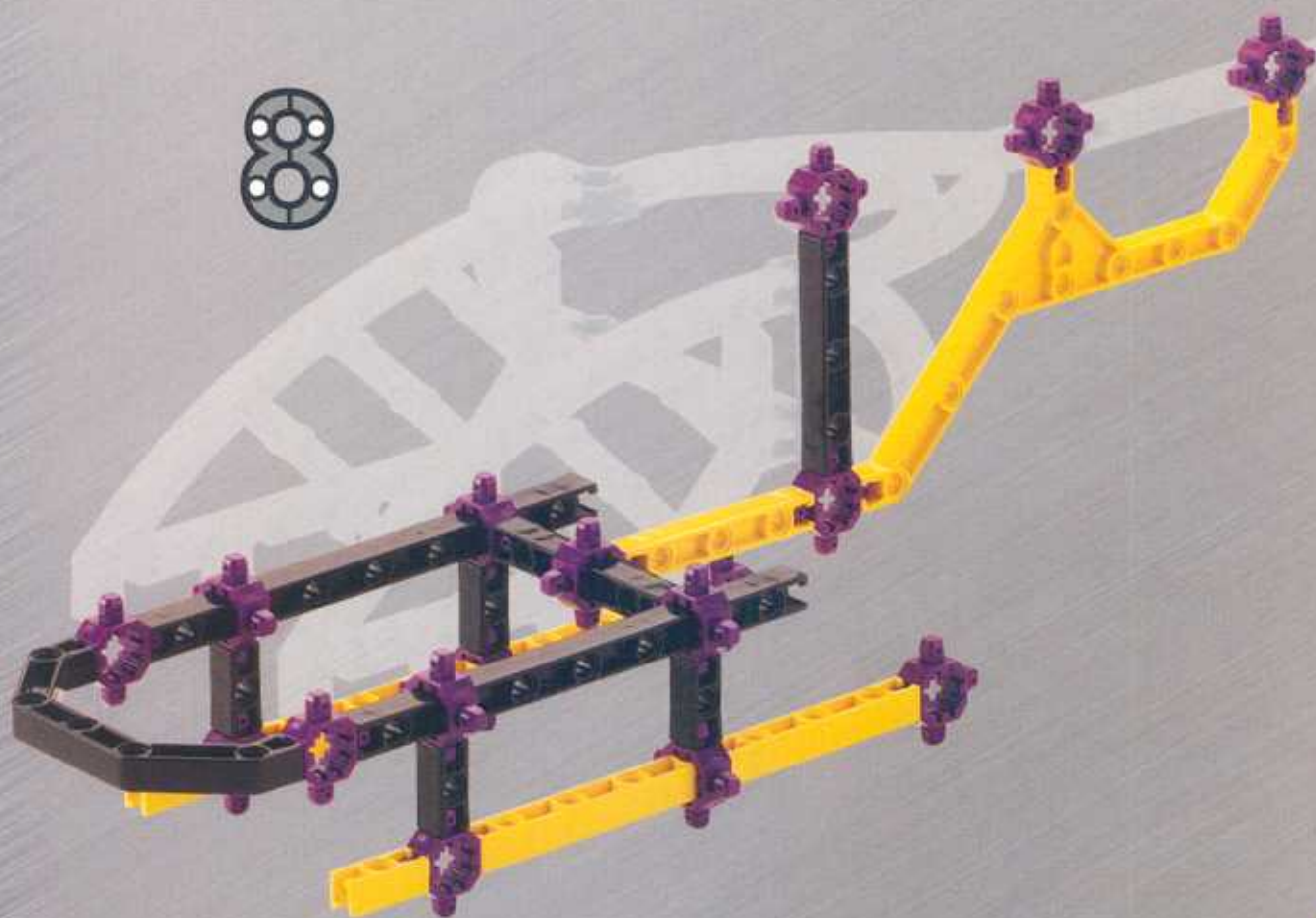

10

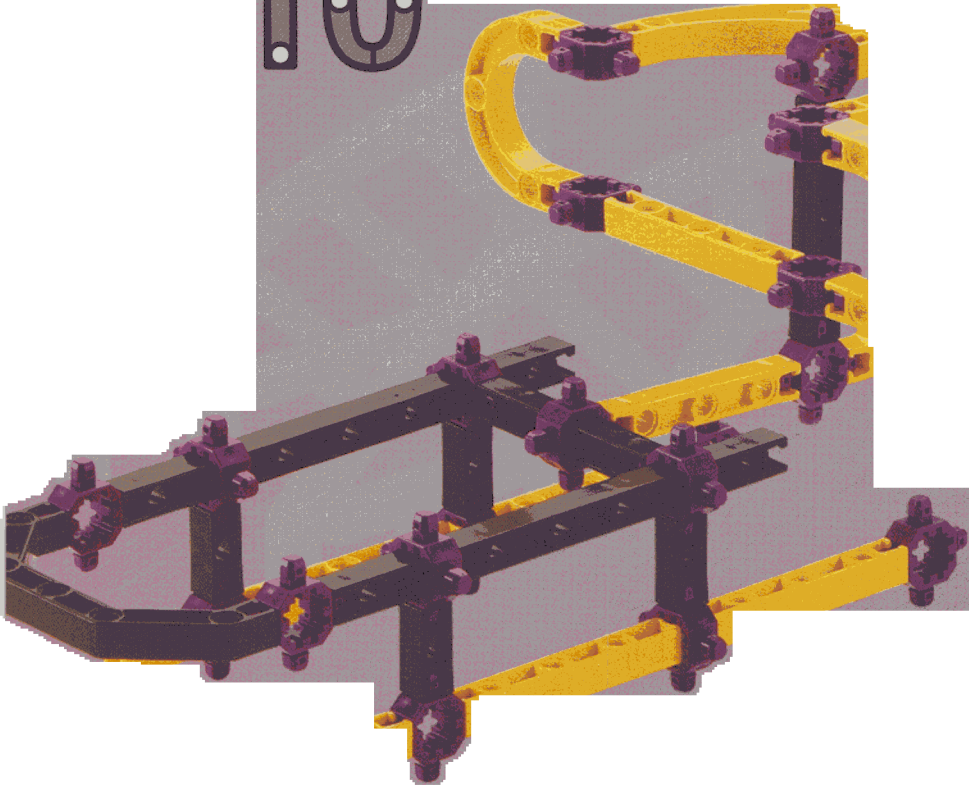

11



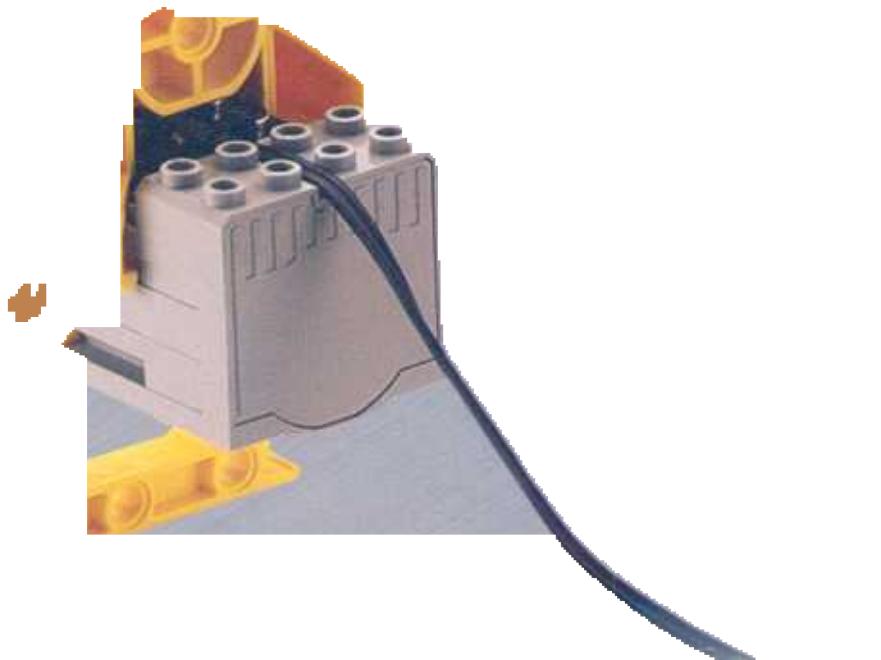
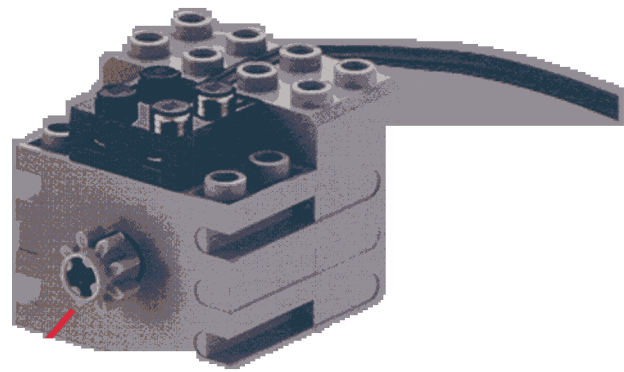
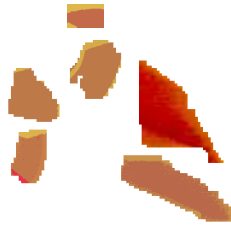
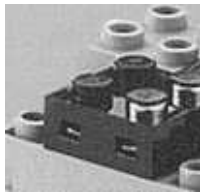

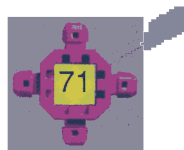
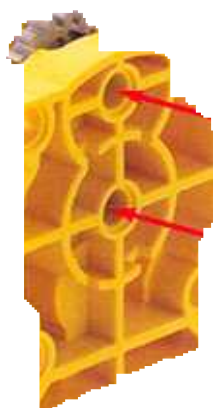
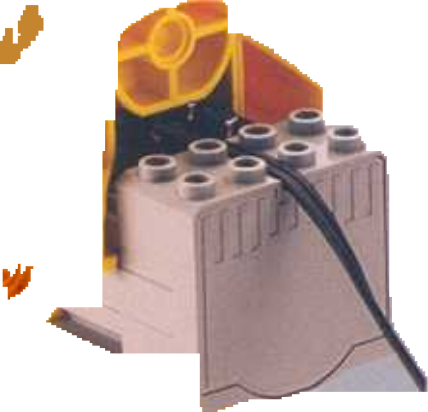

12



13



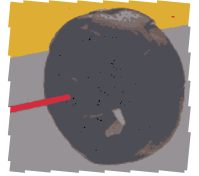

15



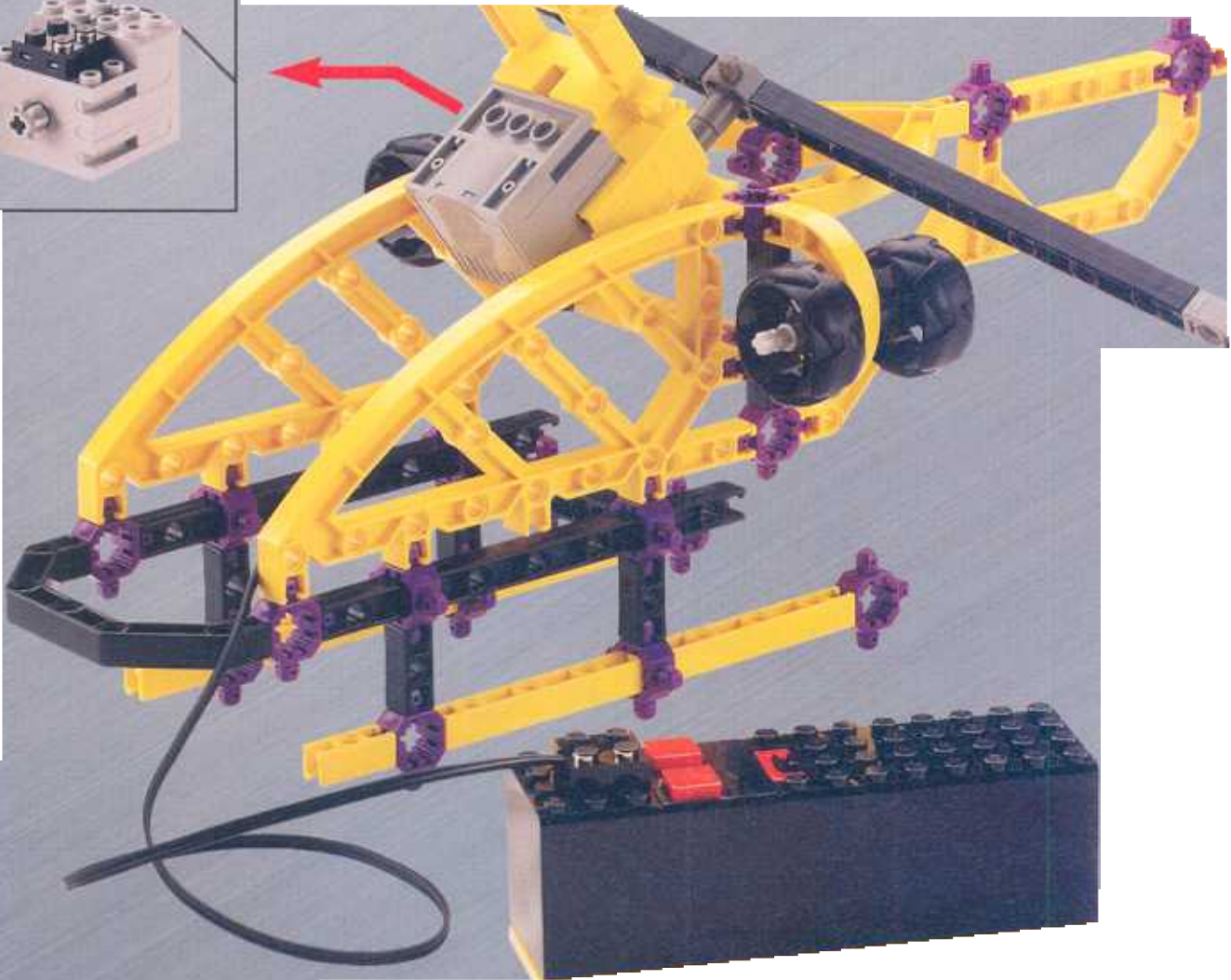
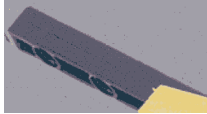

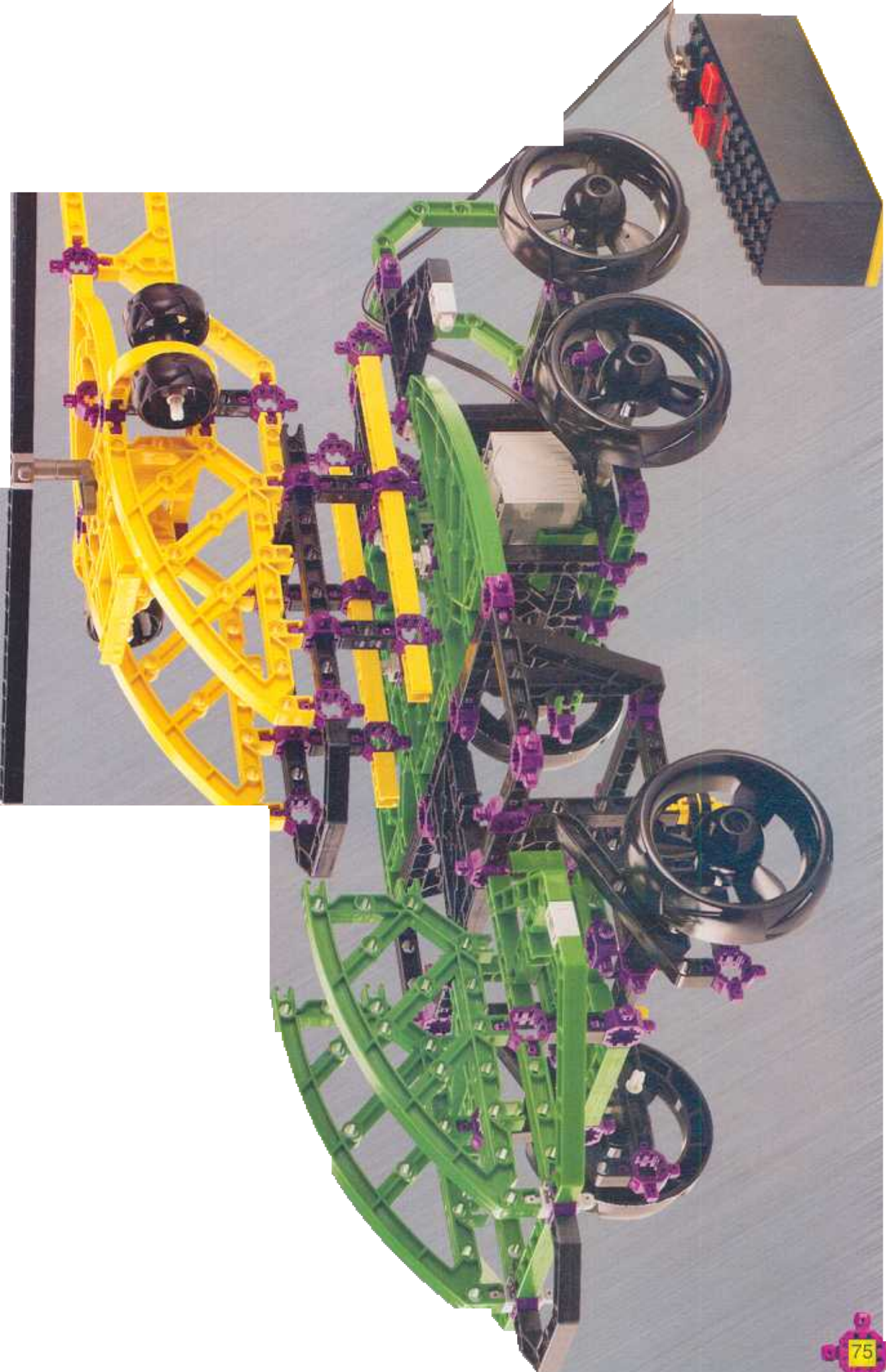







1



2

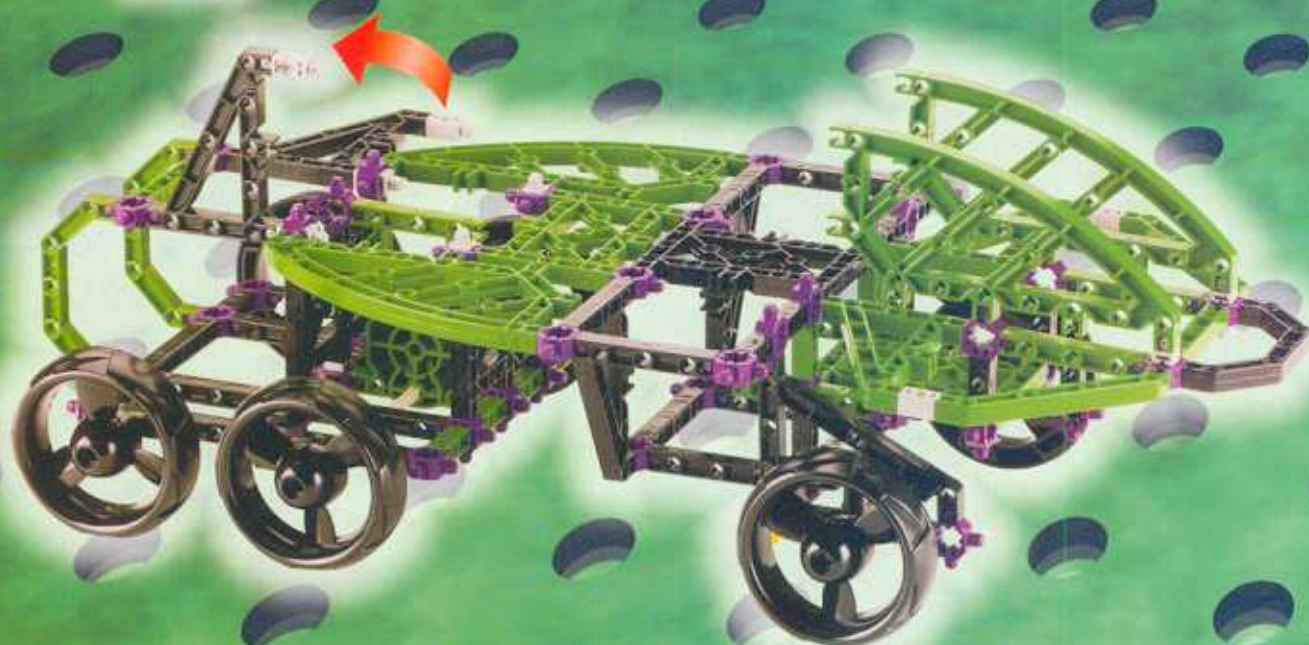

3



4



5



6

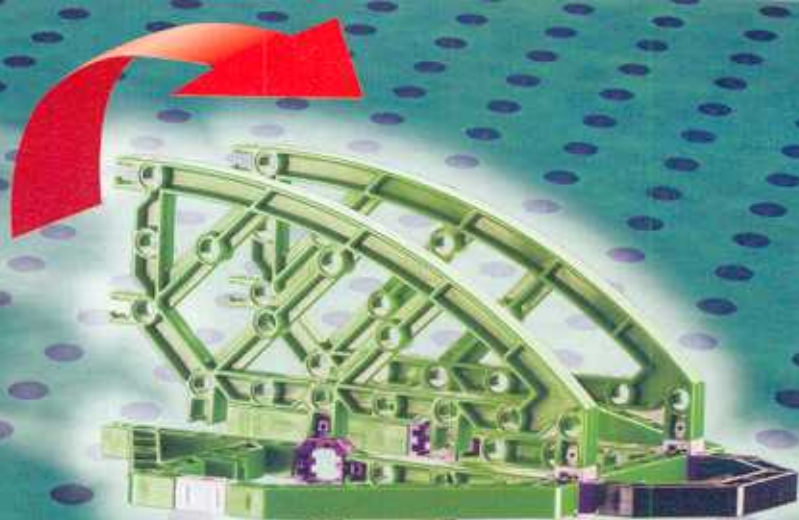

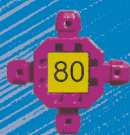
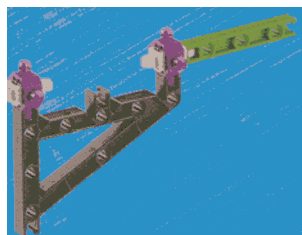
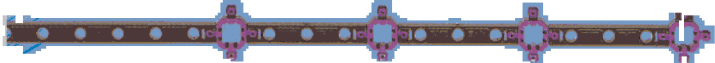

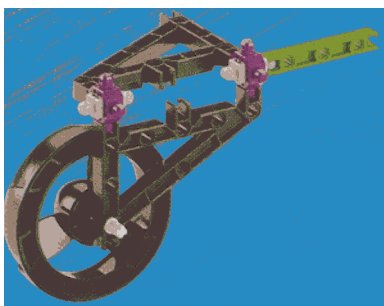
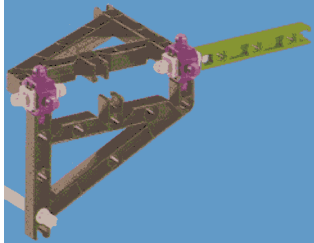

4



5

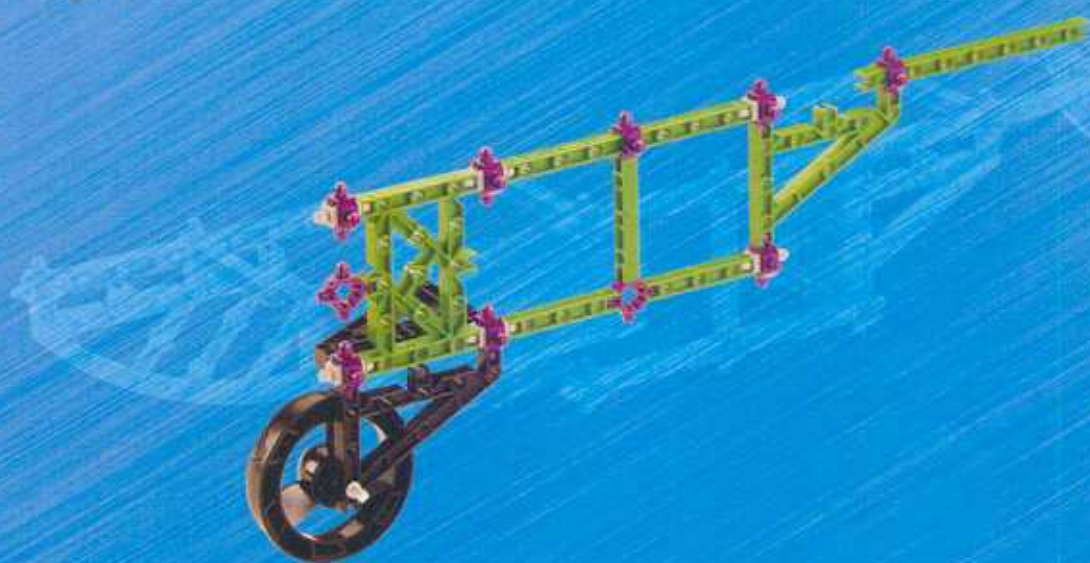

7

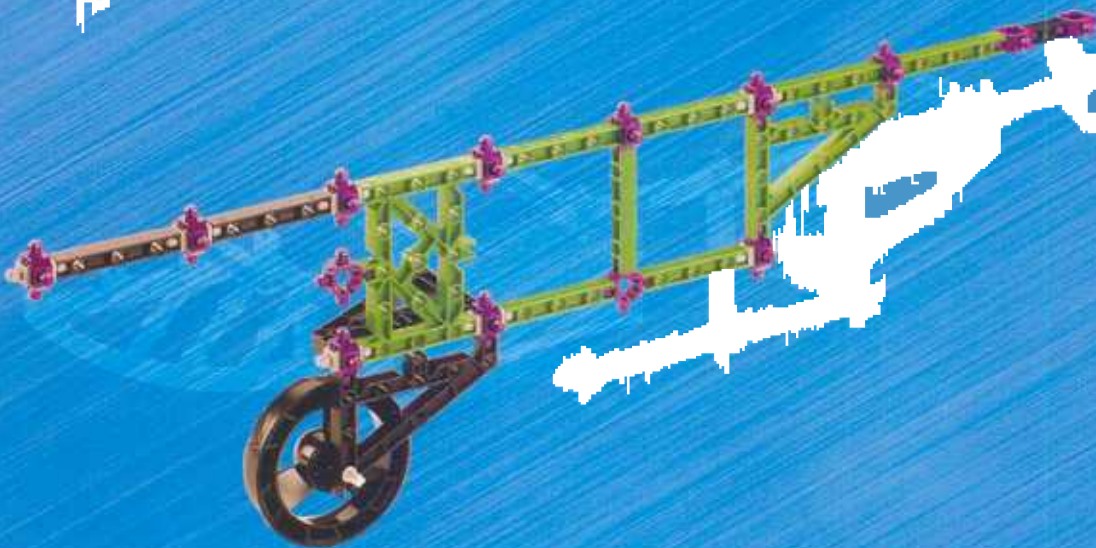

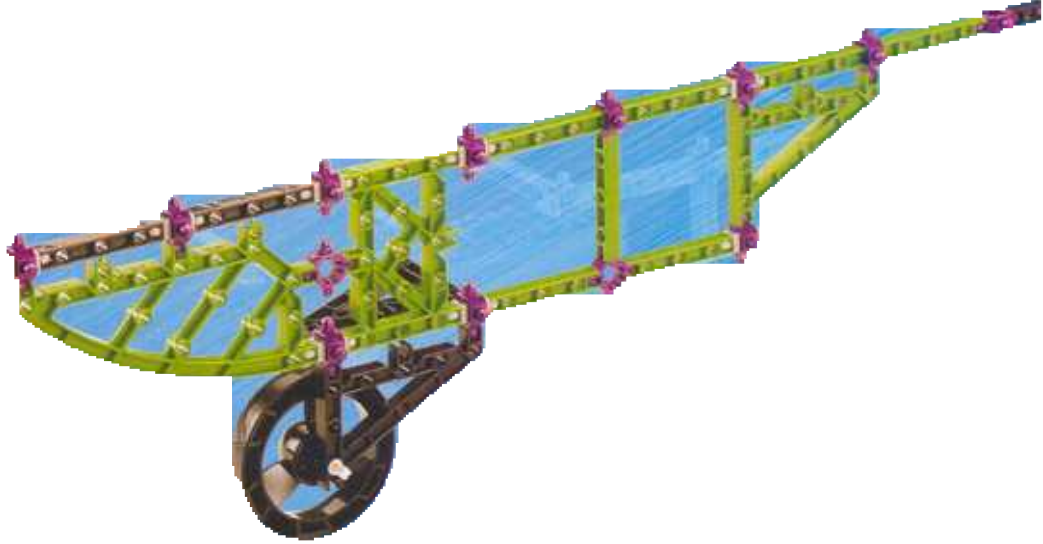

9

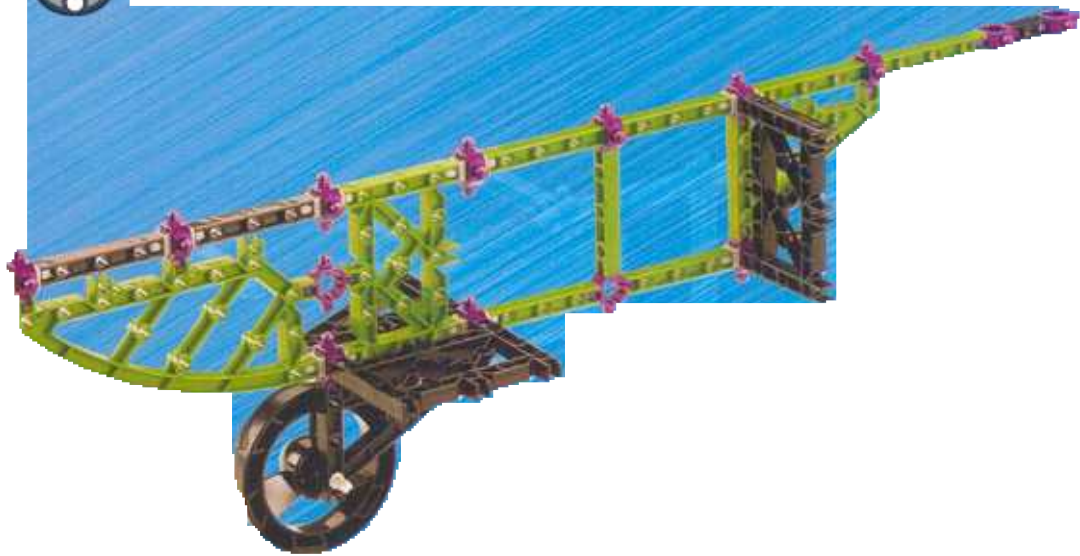

10

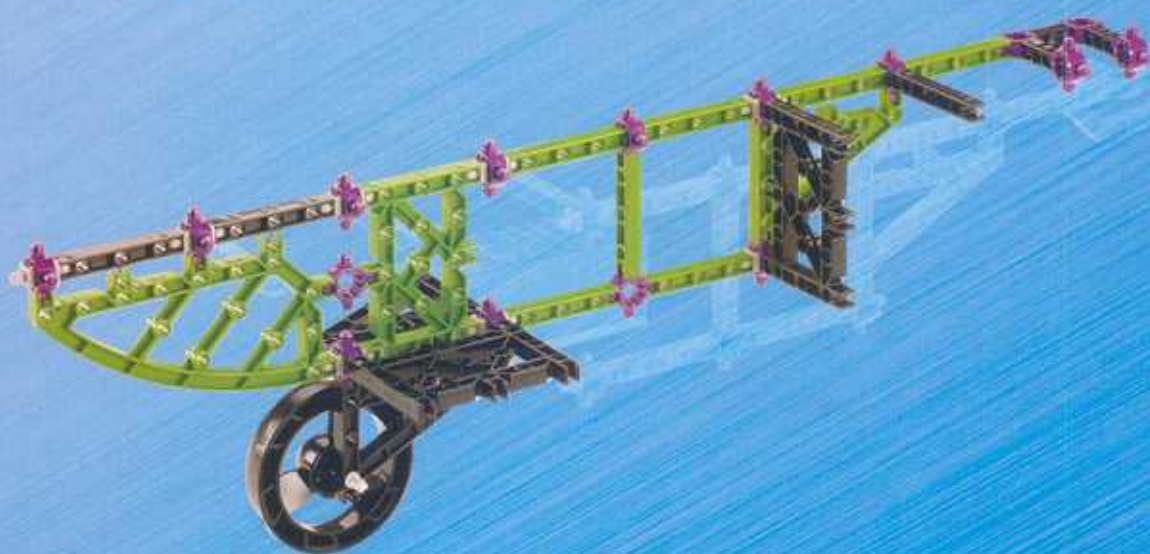

11



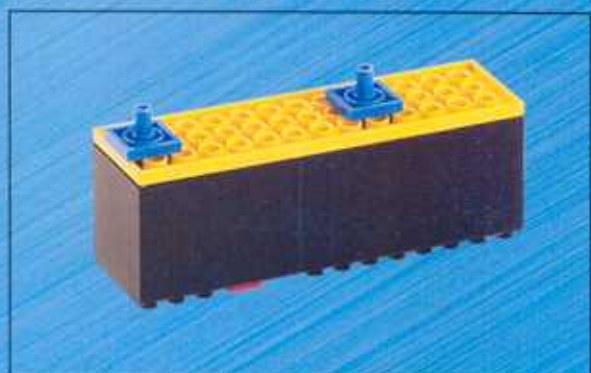

12

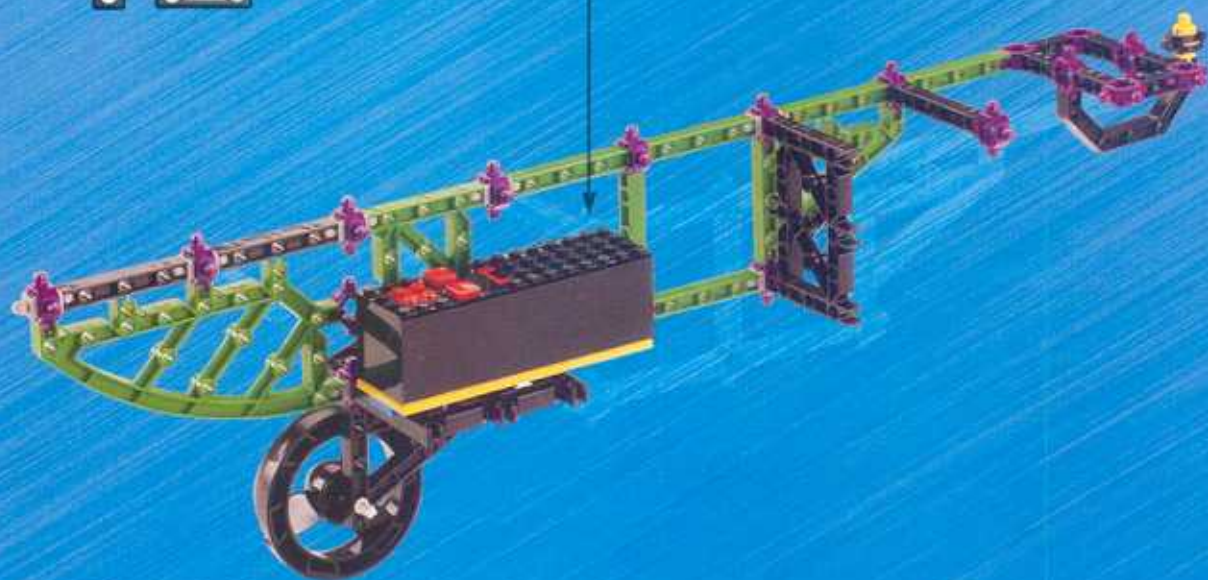

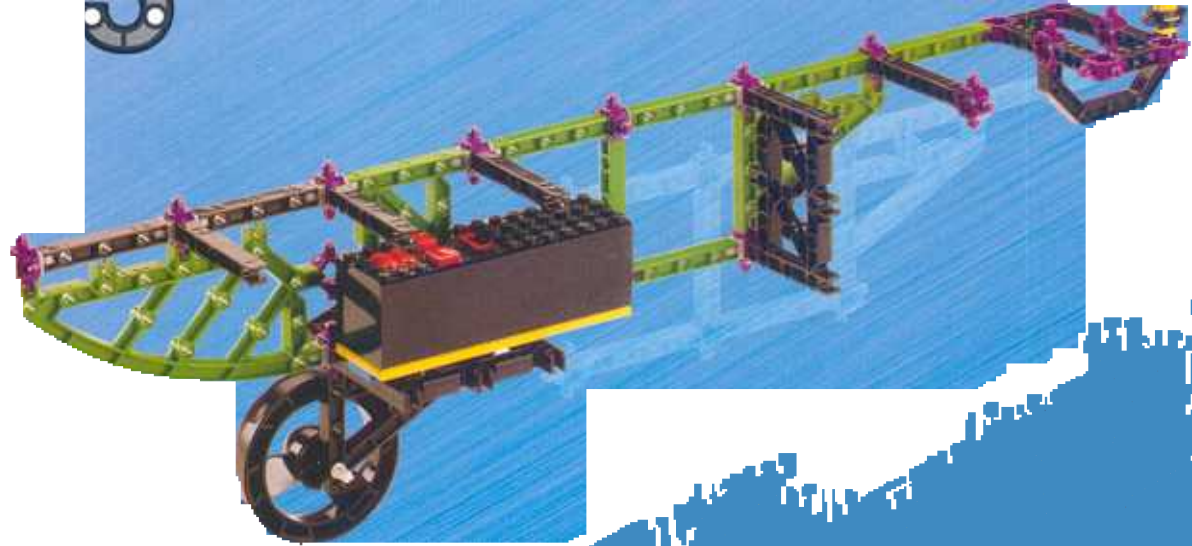

14

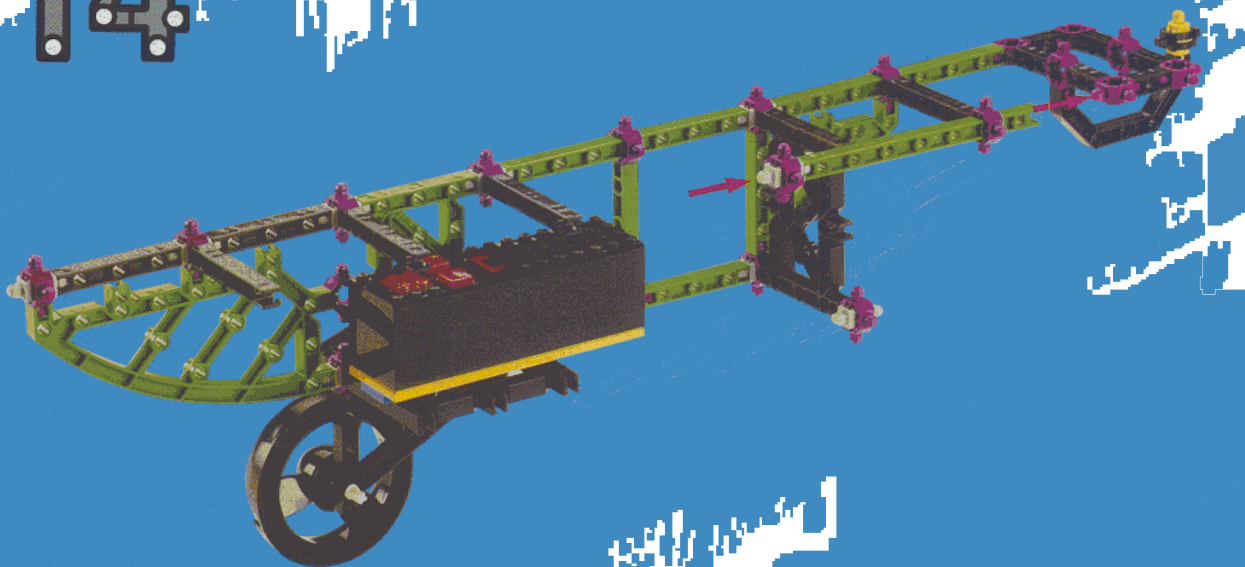

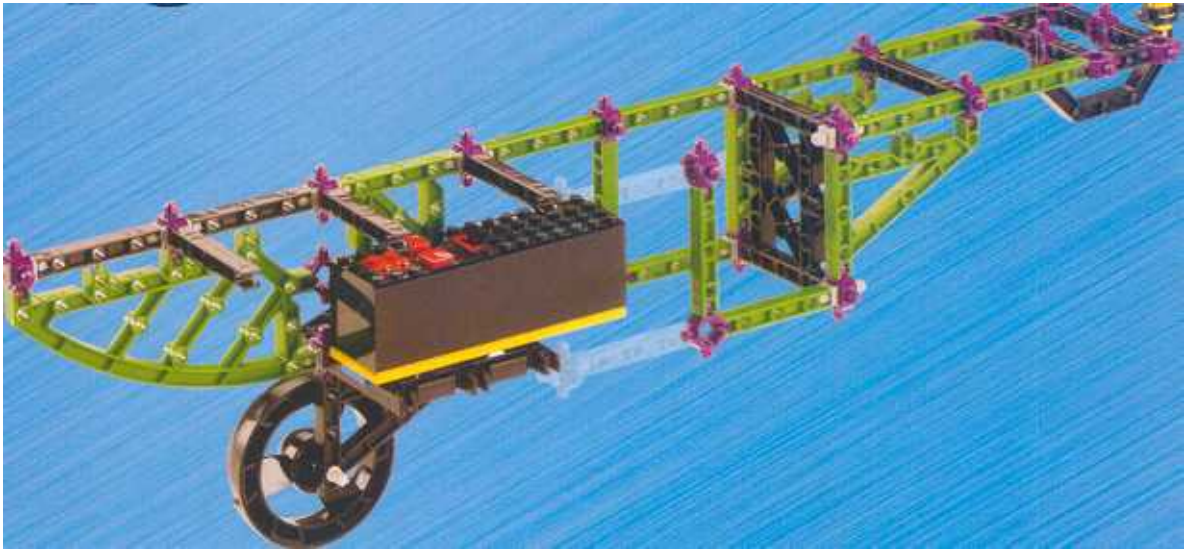

16

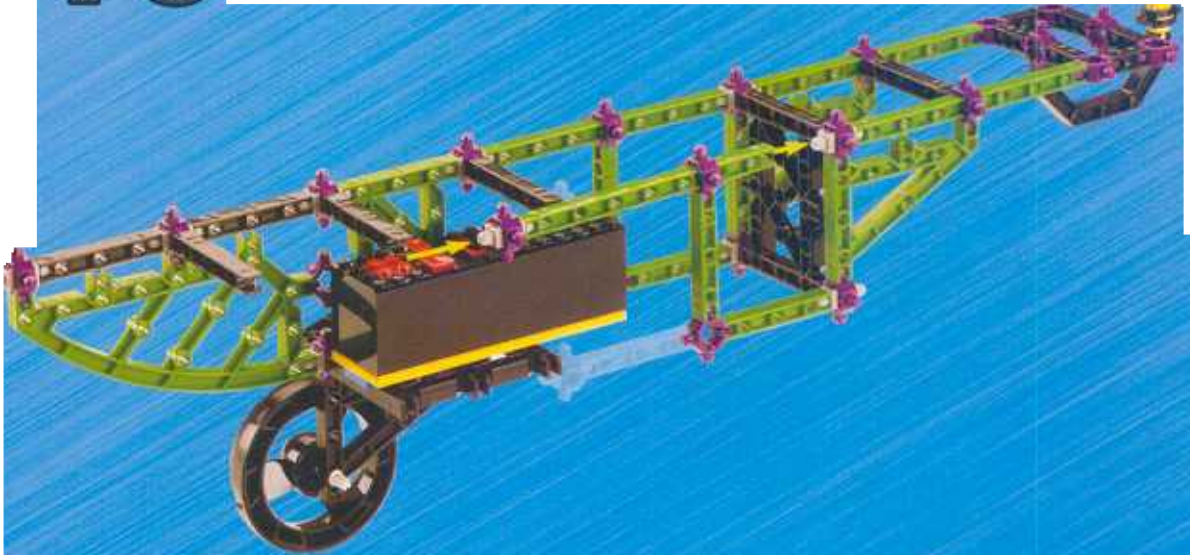

17



18



19

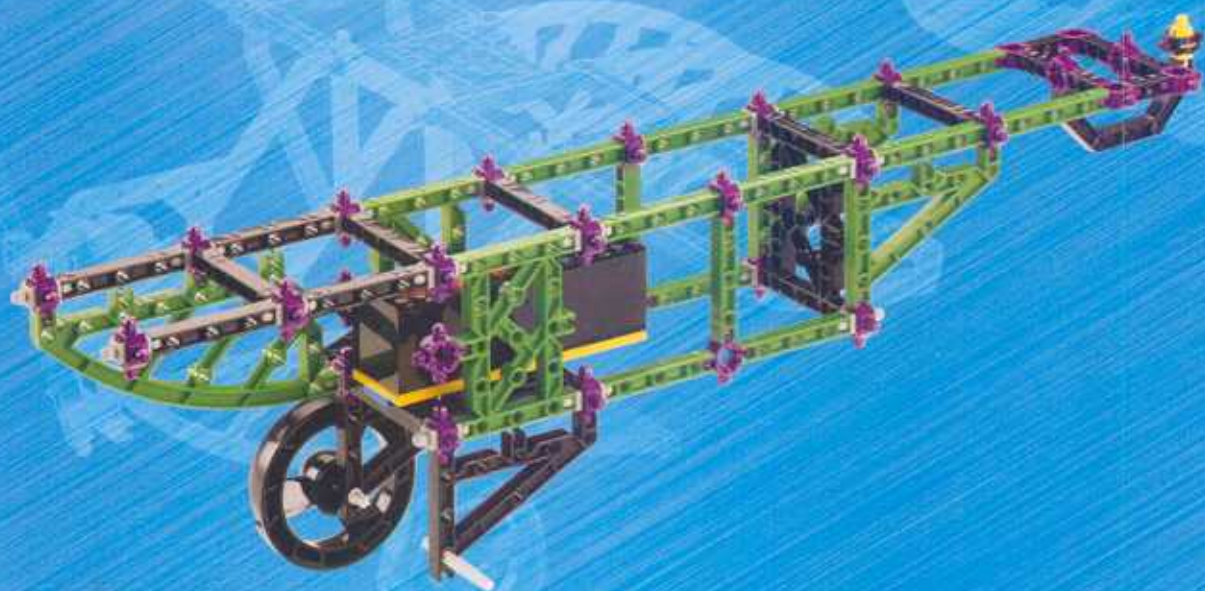

20



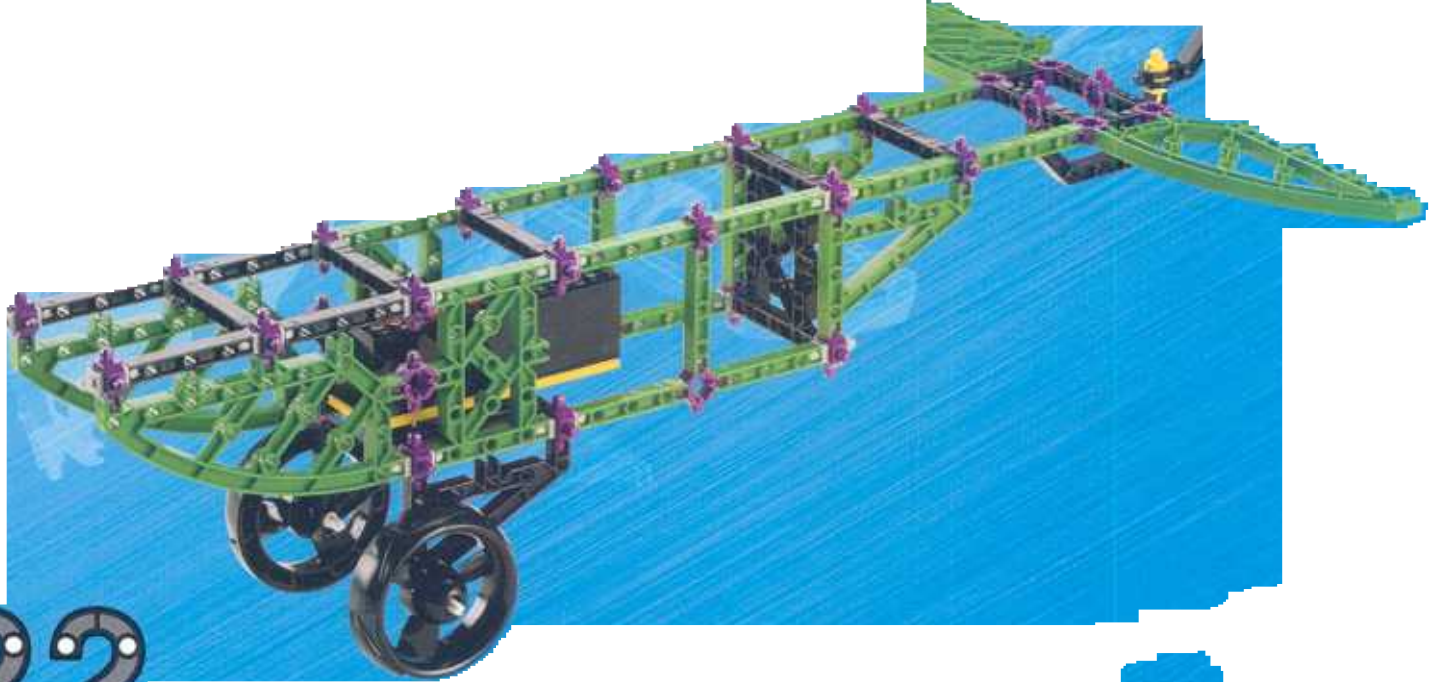

22

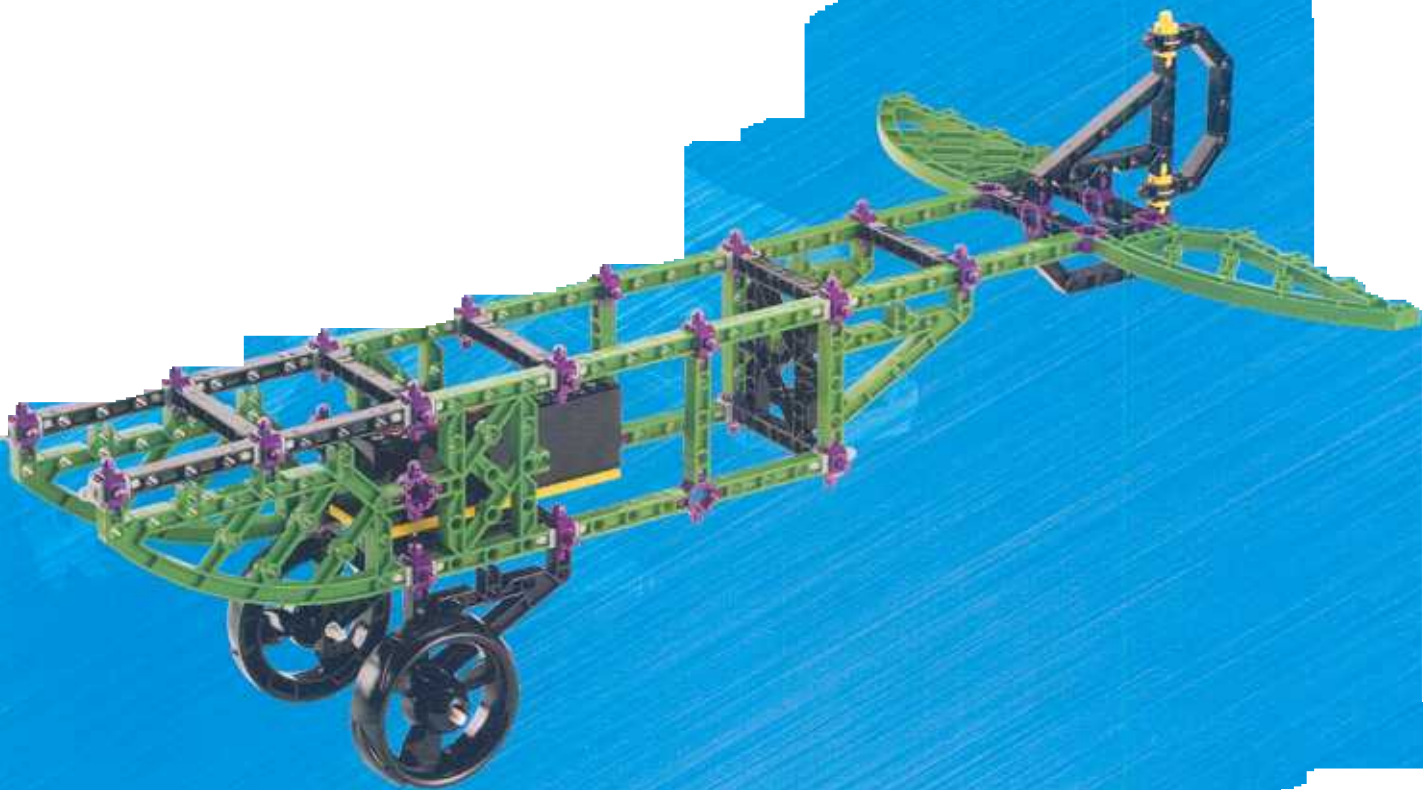

23



24

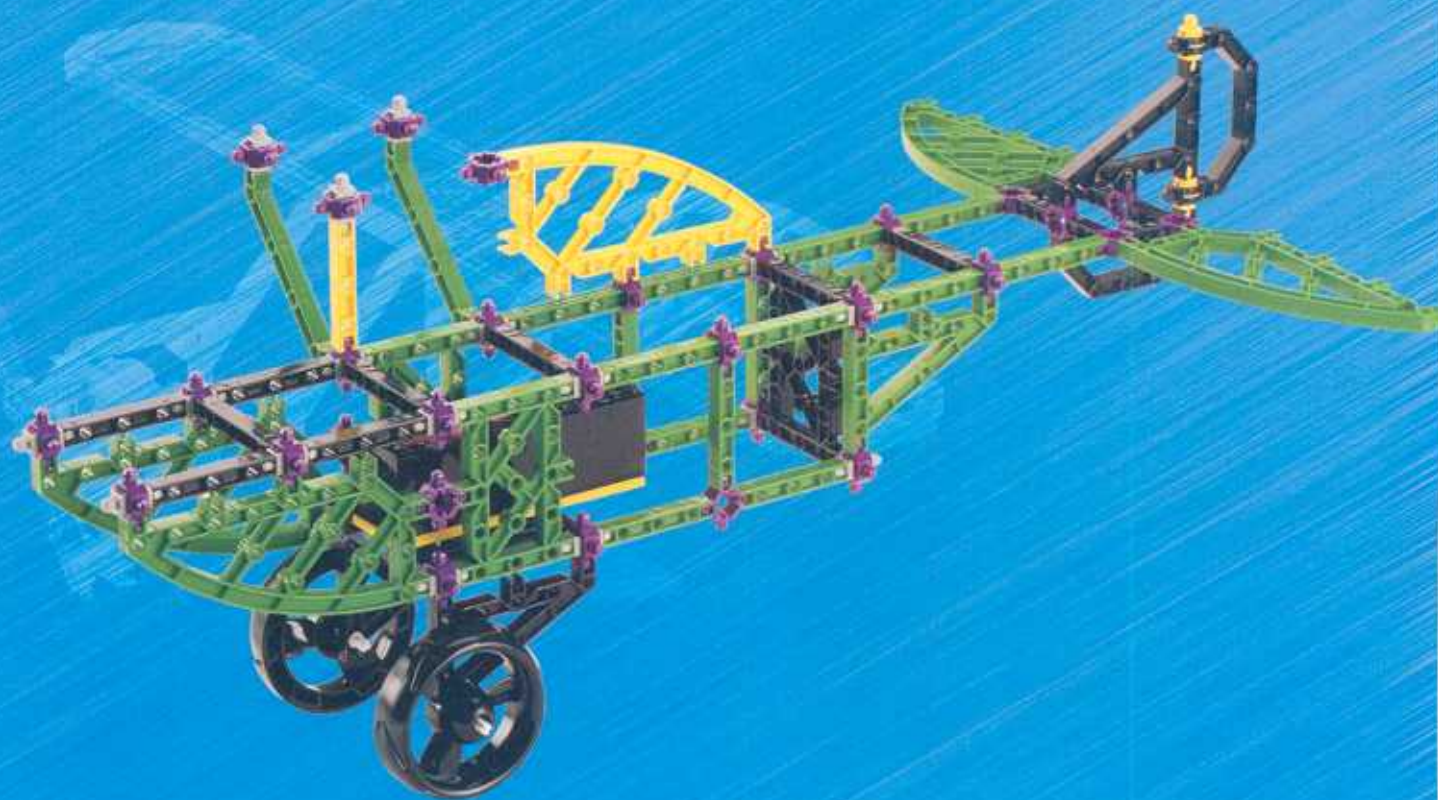

1



2

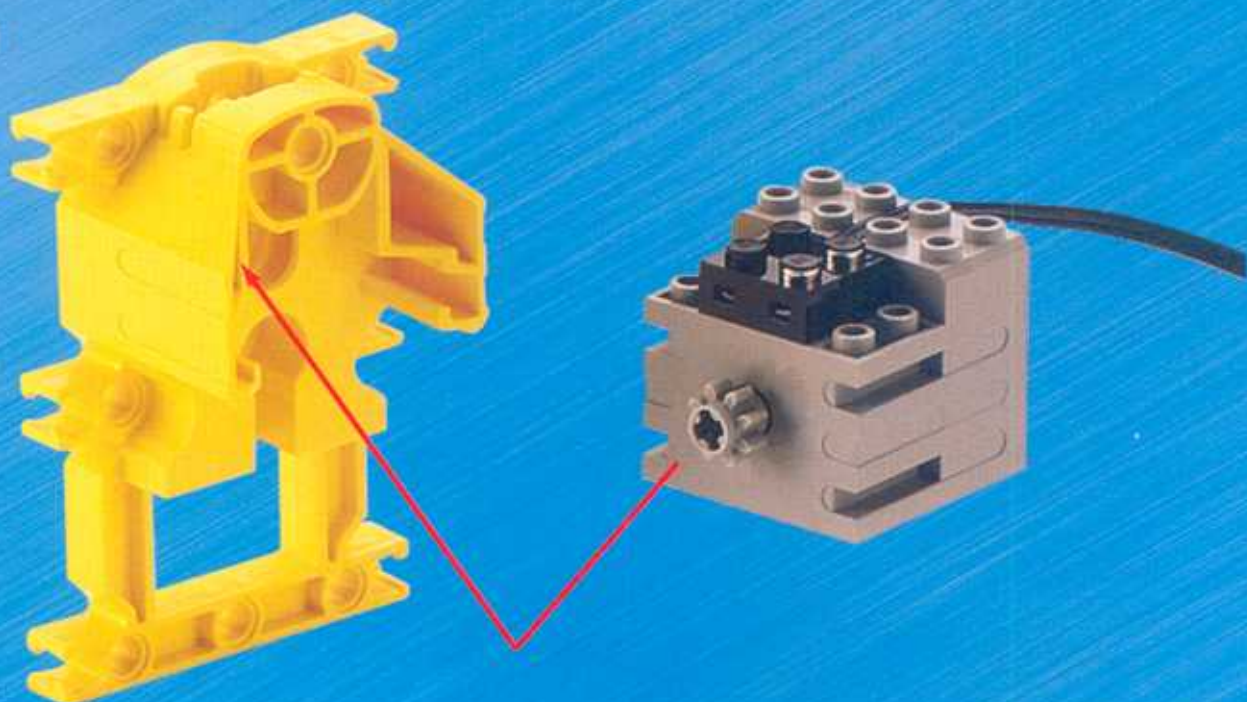

3

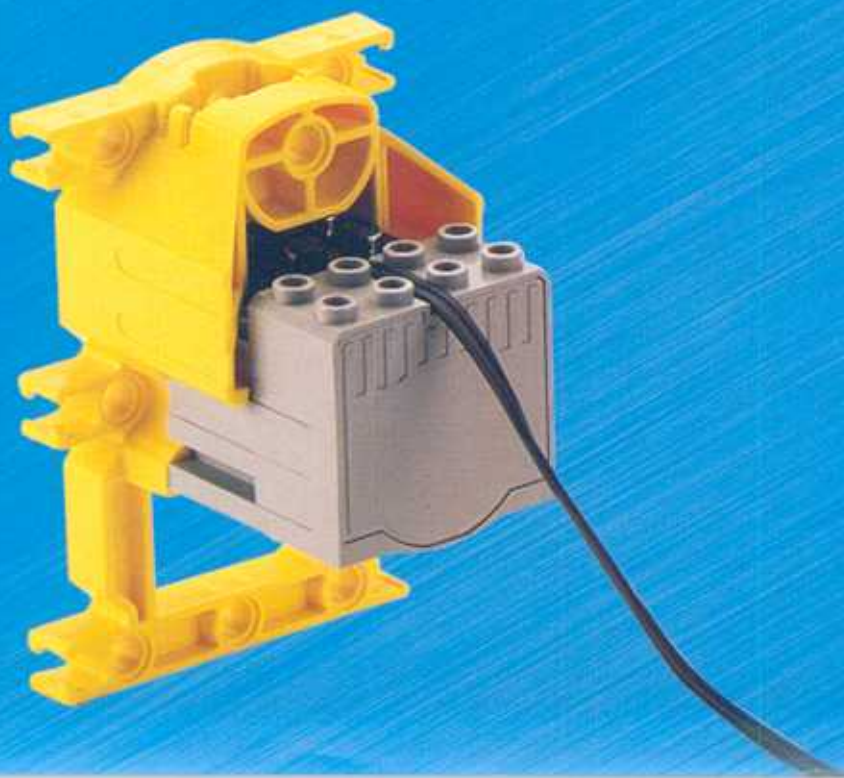



4



5

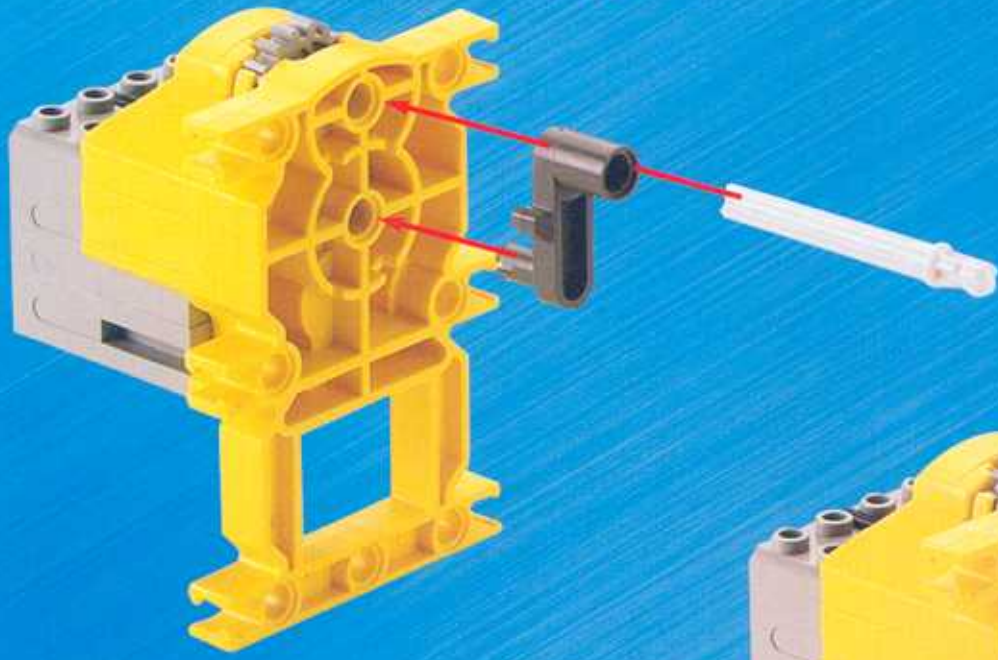

6



25



26



27



28



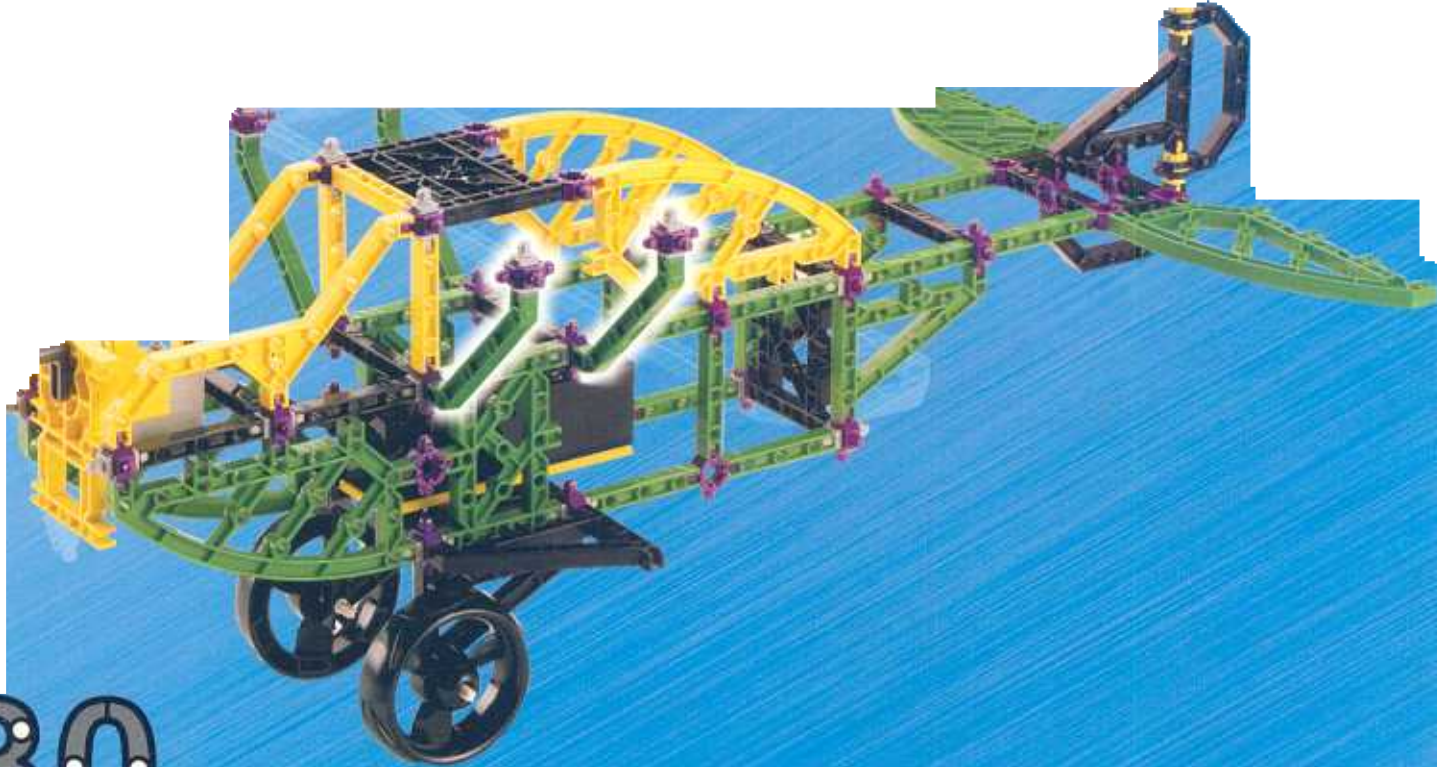

30



31



32



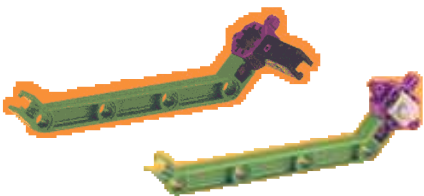
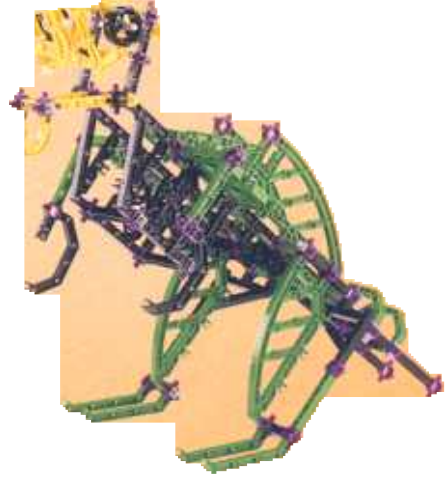

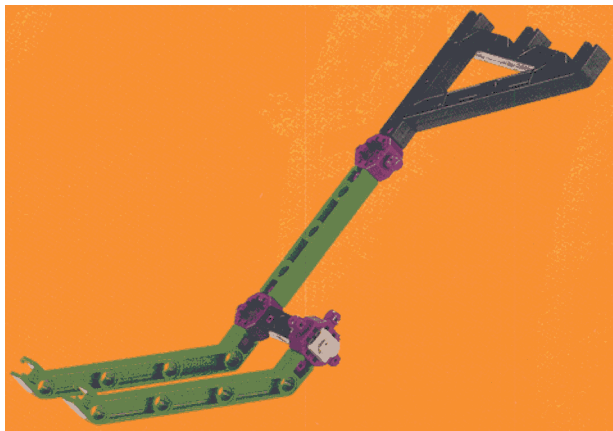

4



5

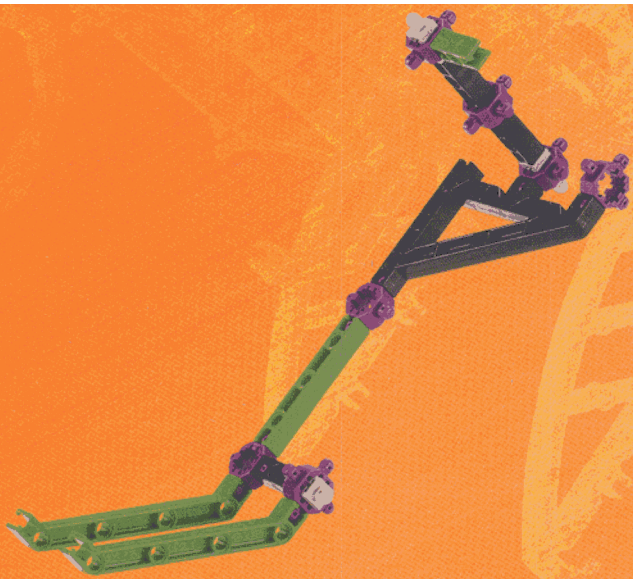

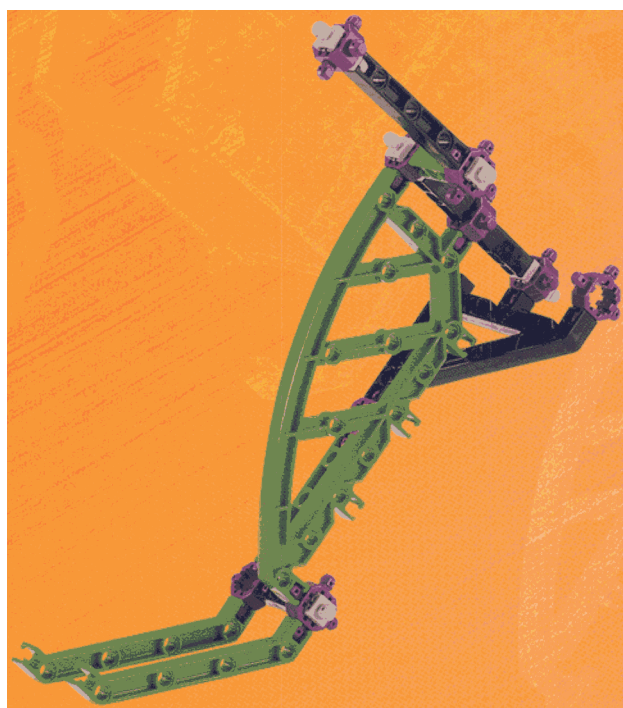

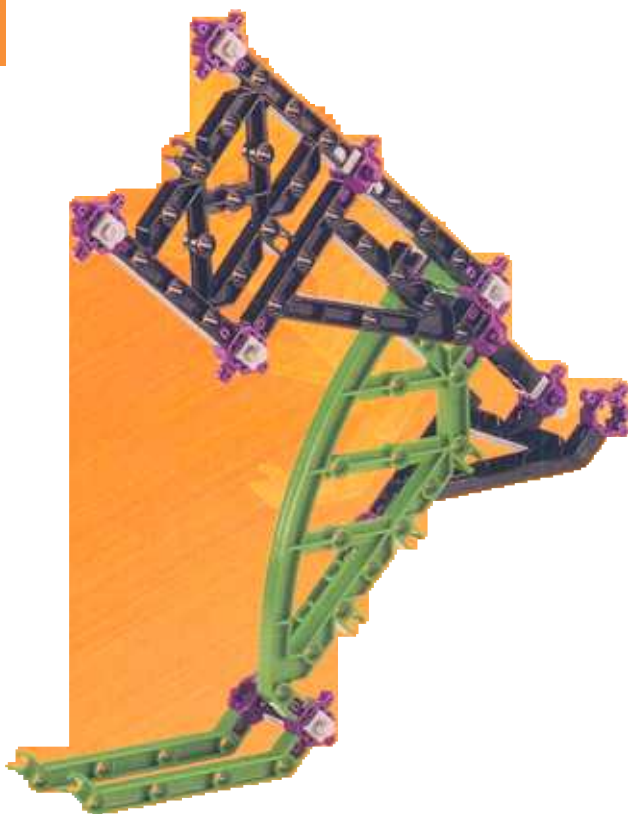

10

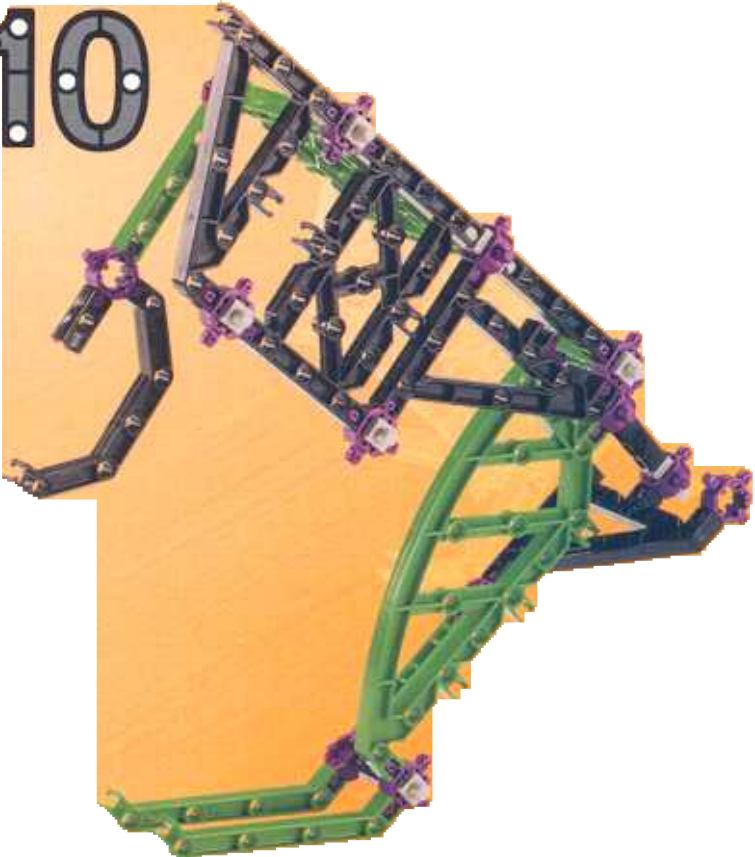

11

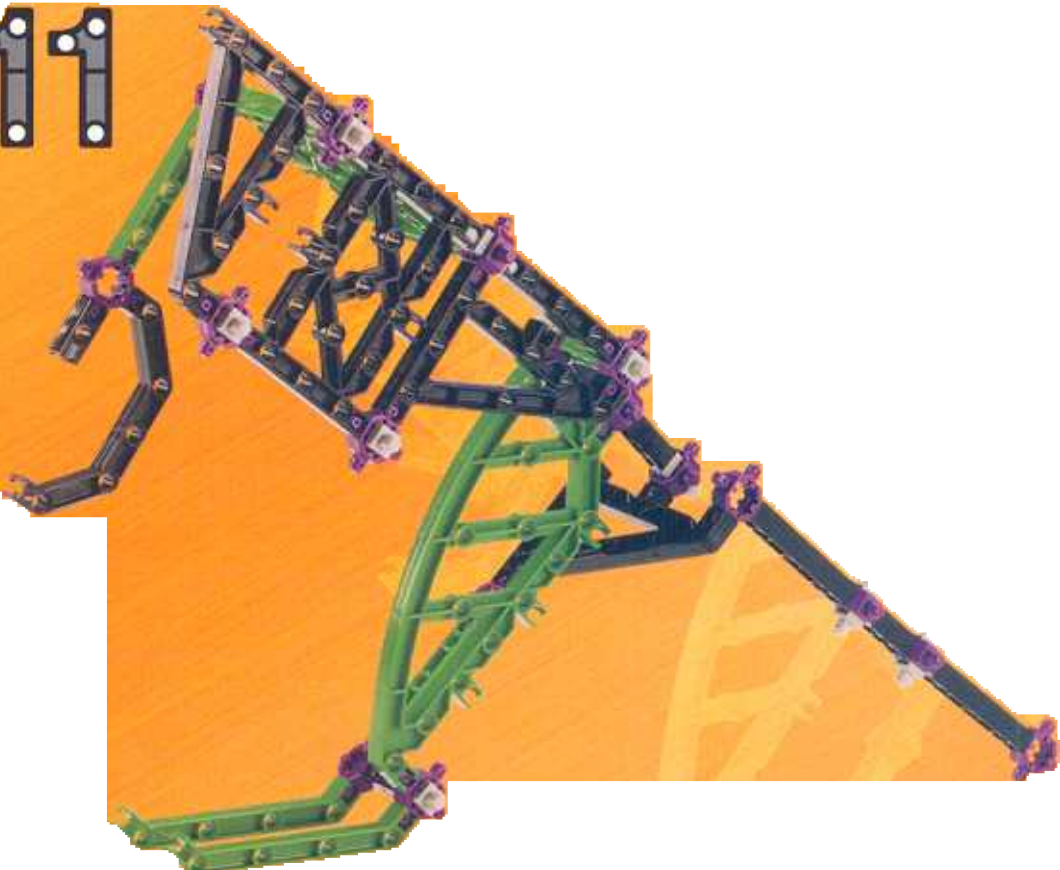

104



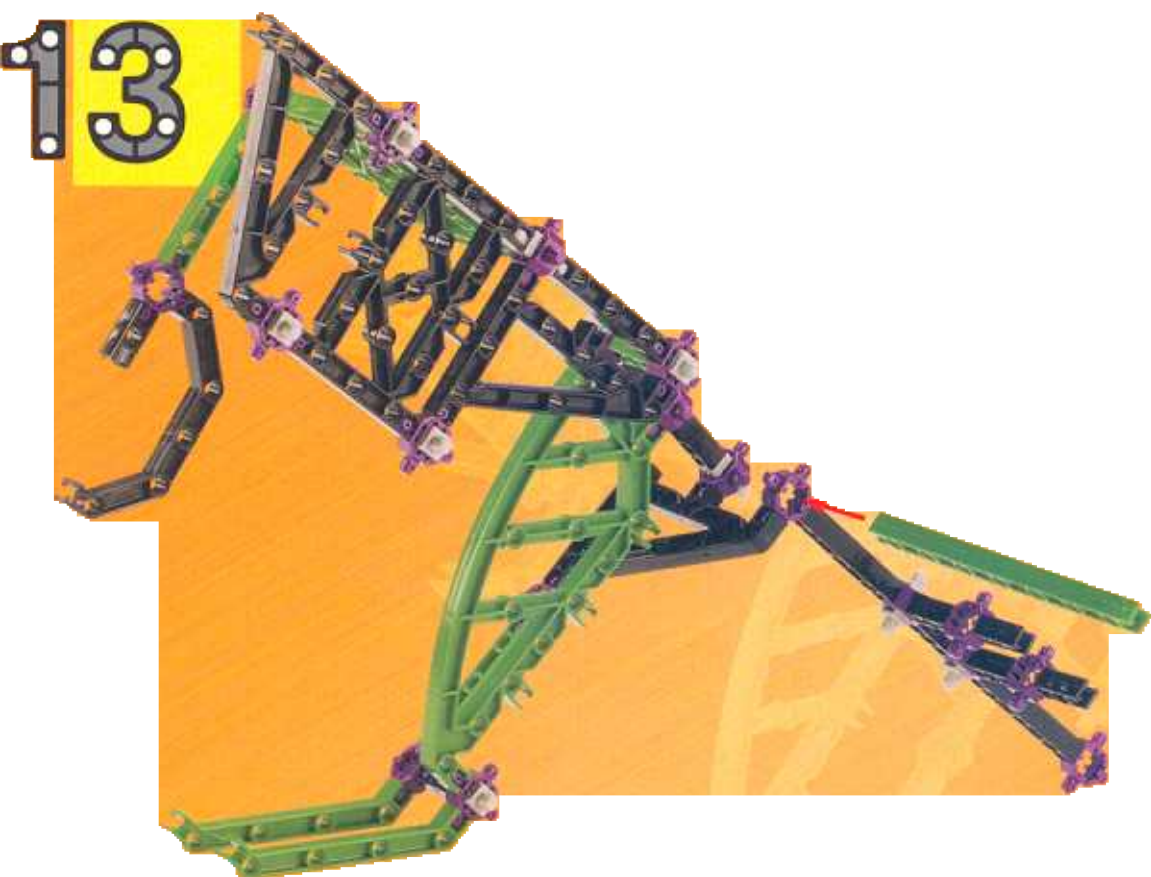
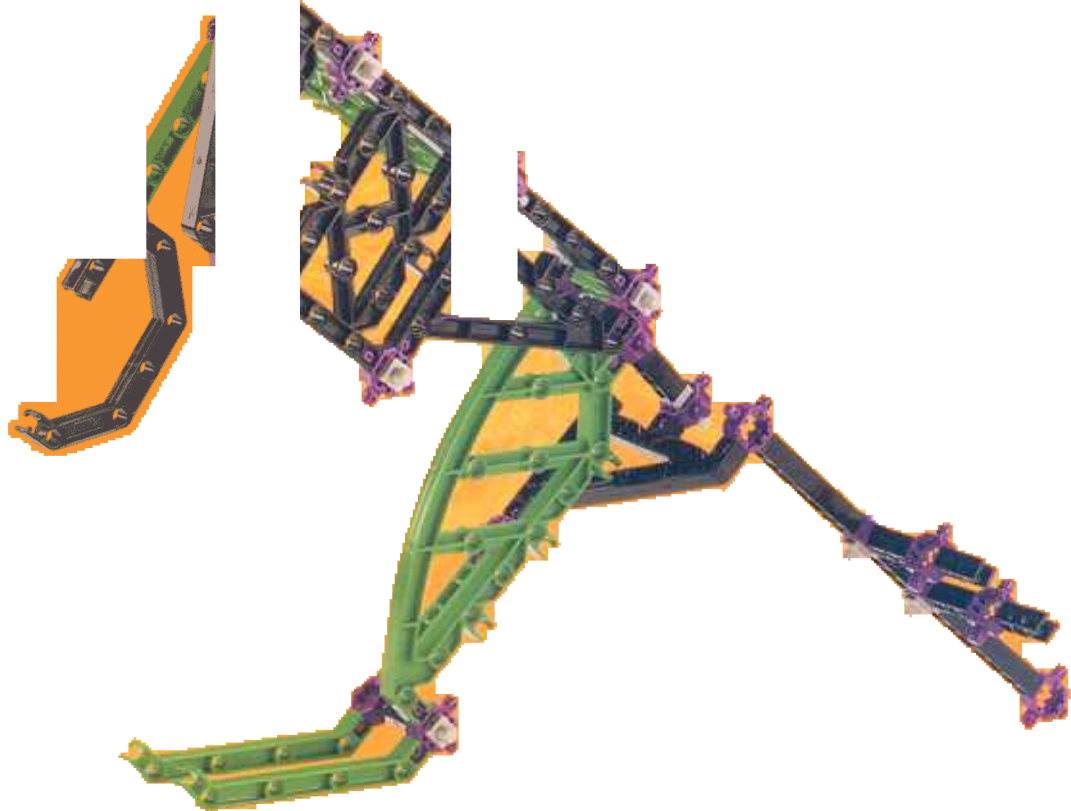

14

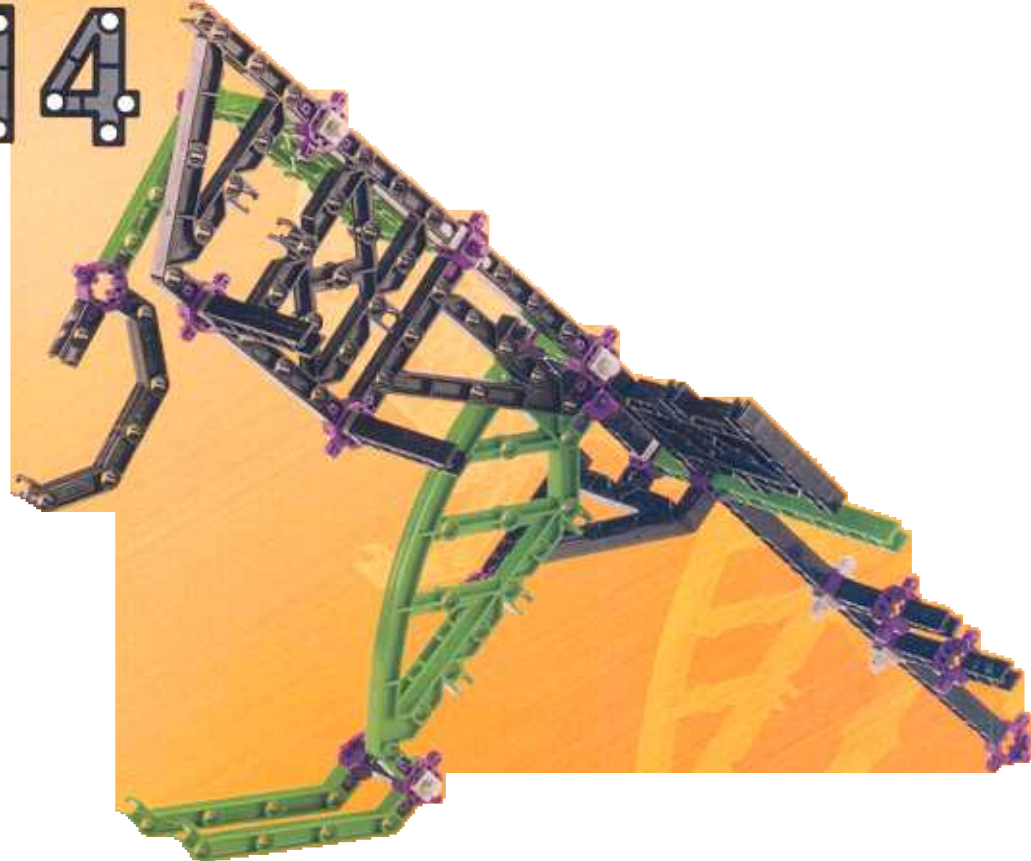

15

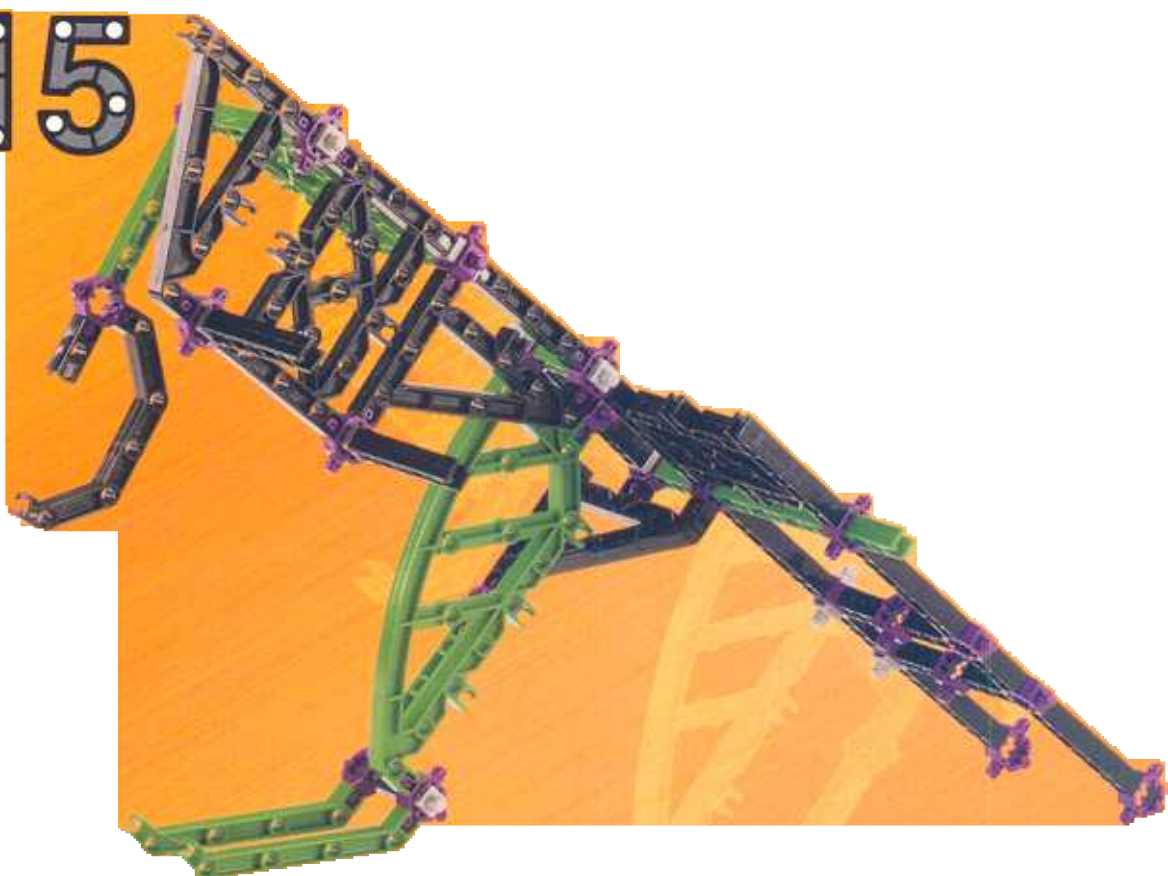

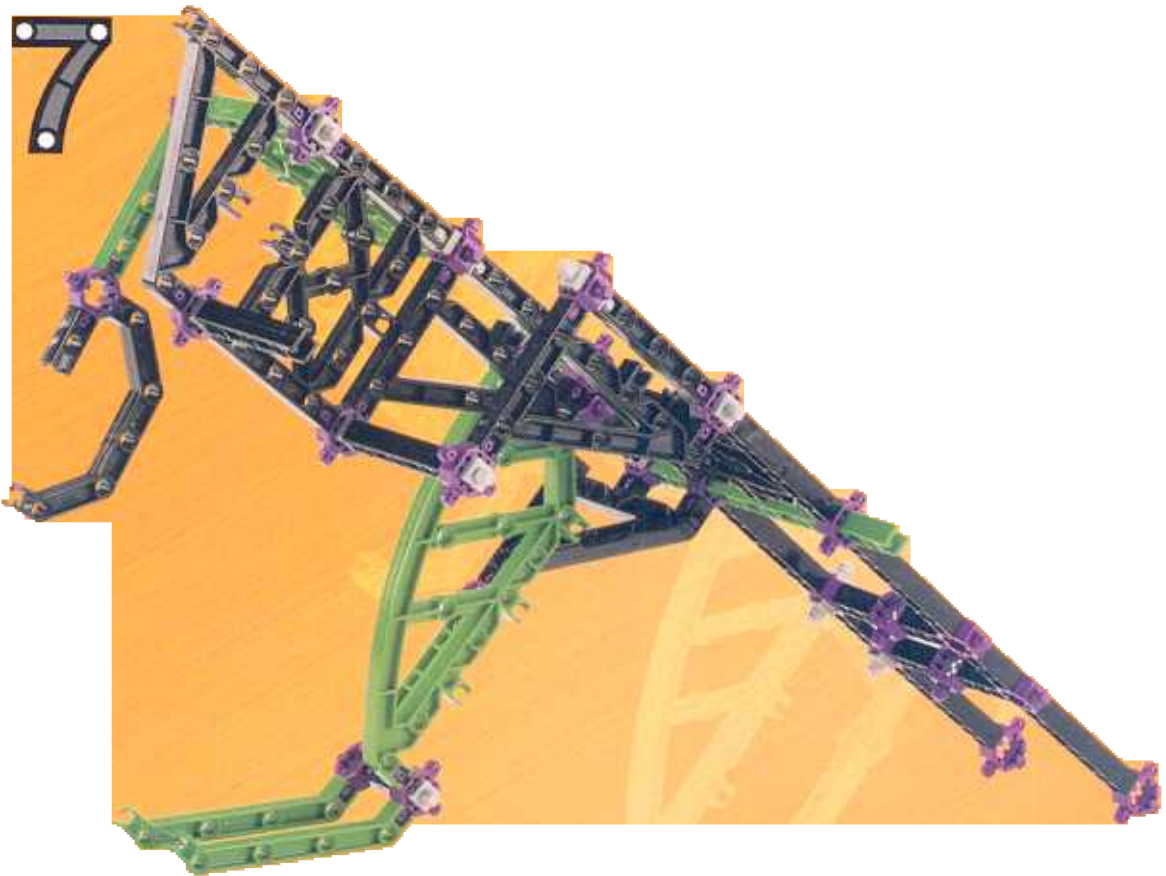
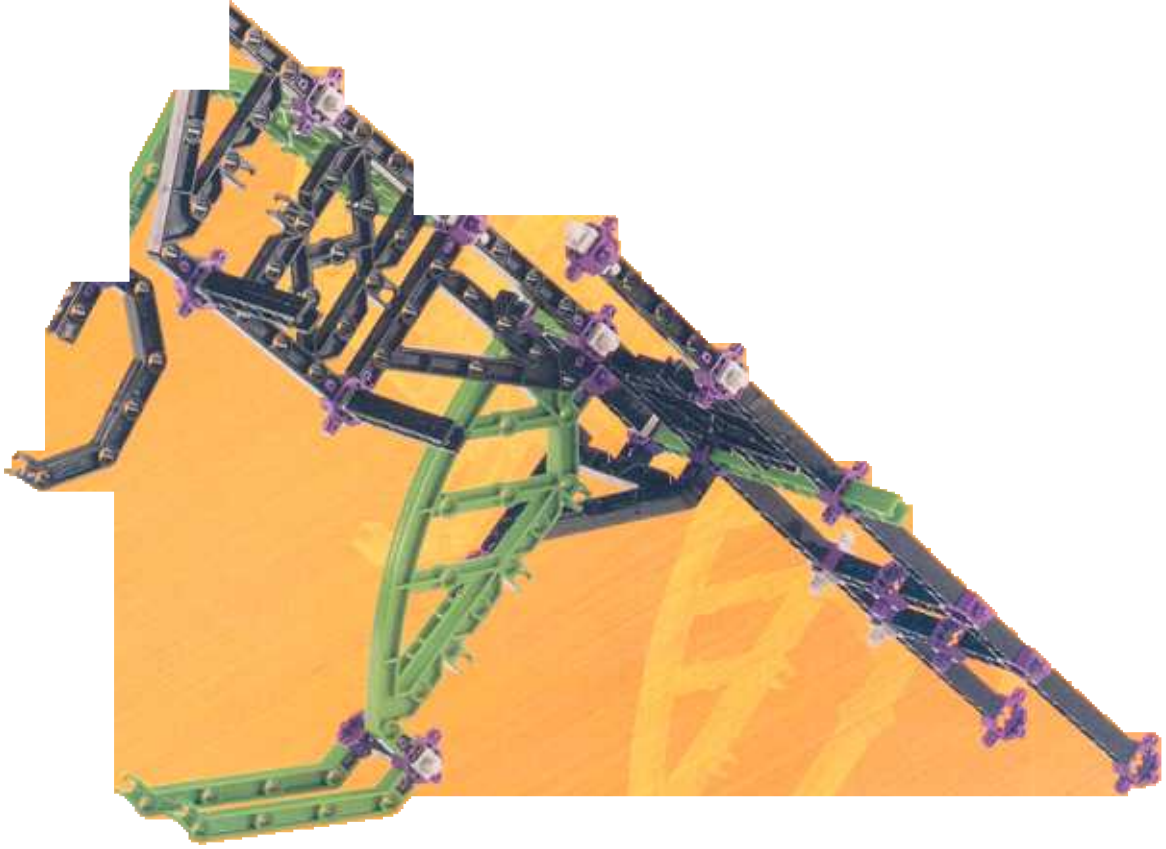

18

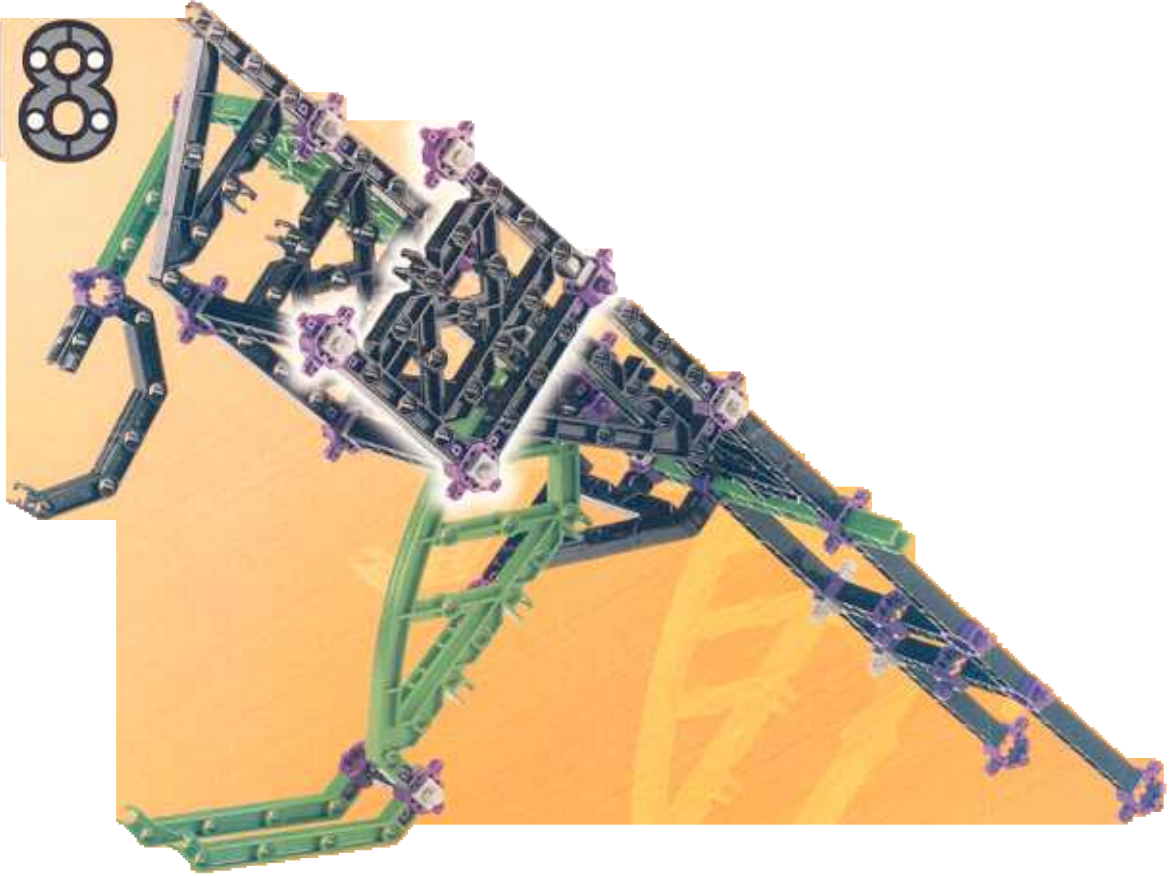

19

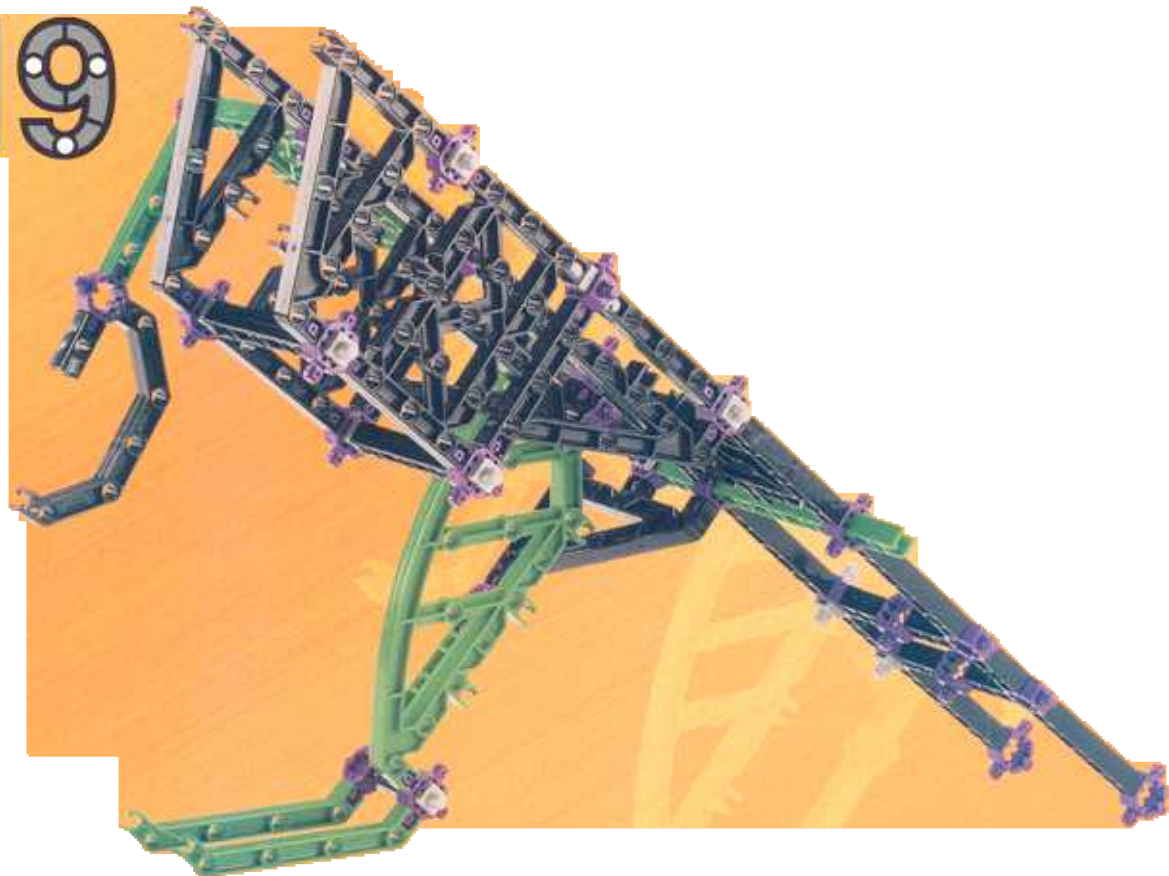

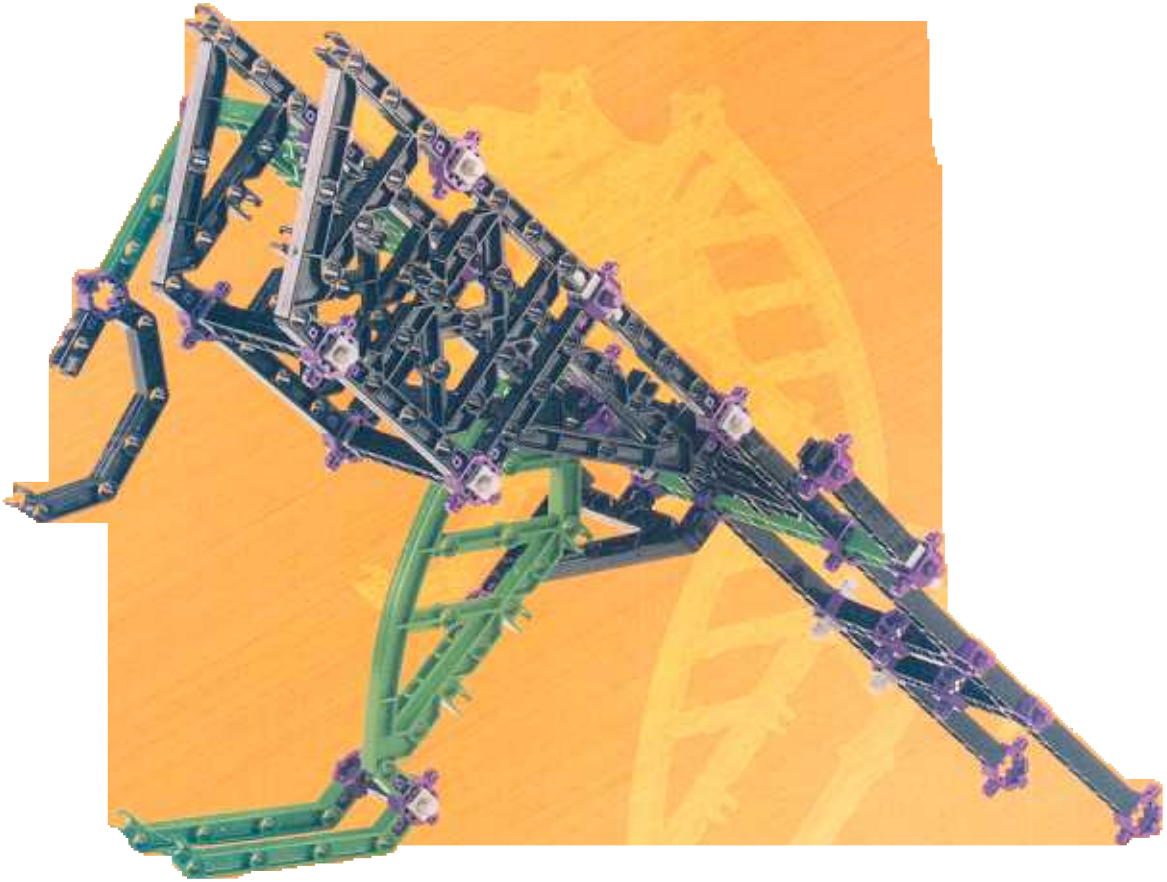

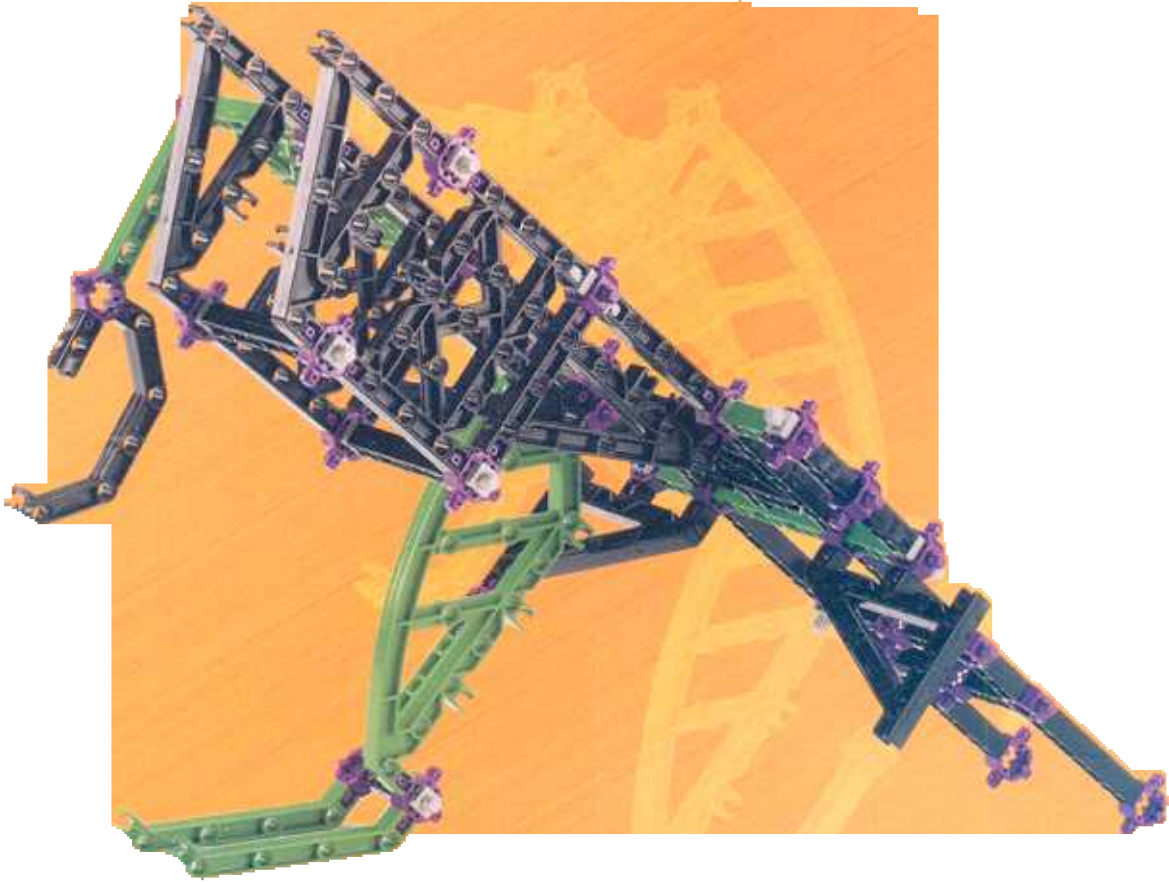

22

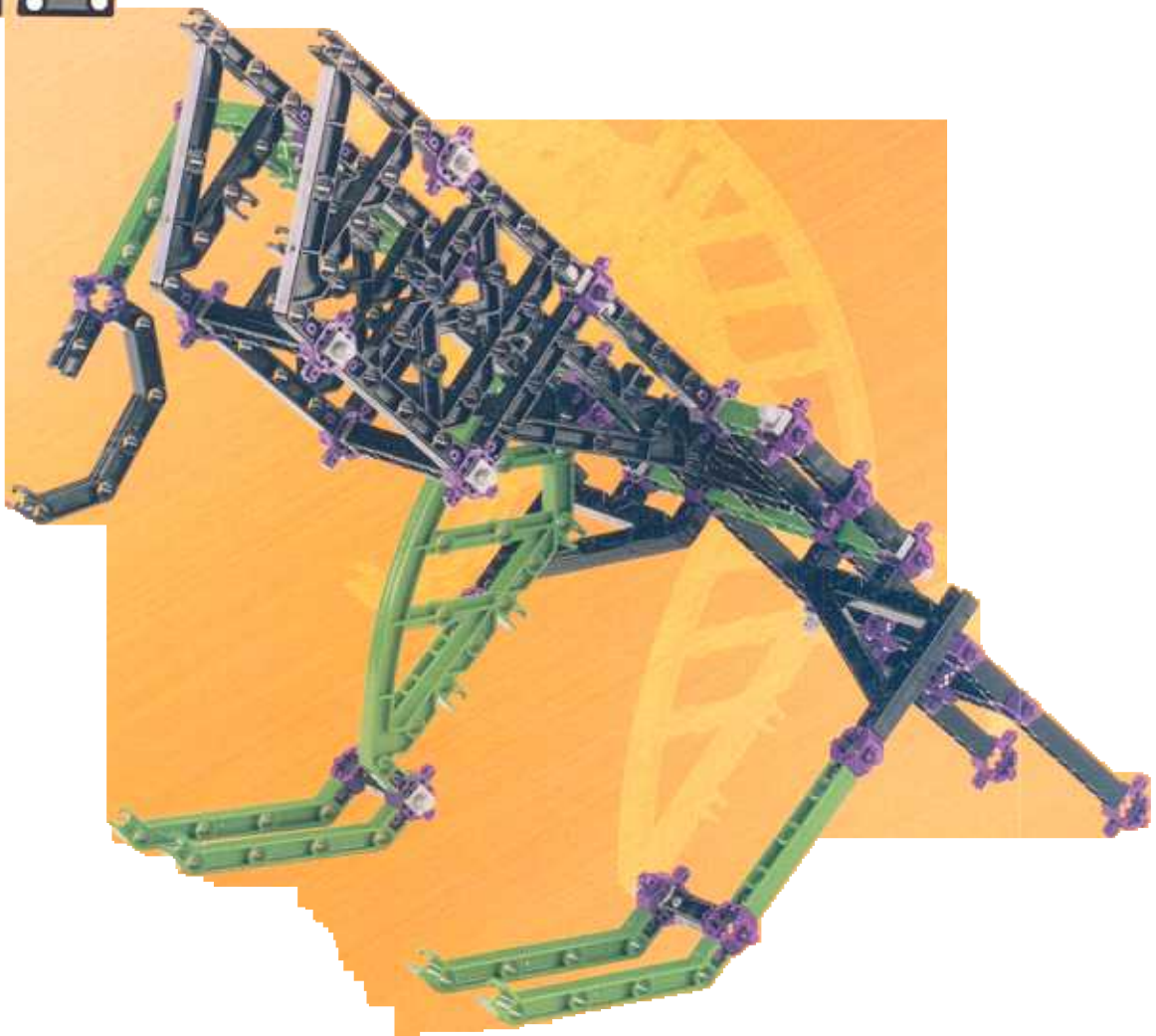

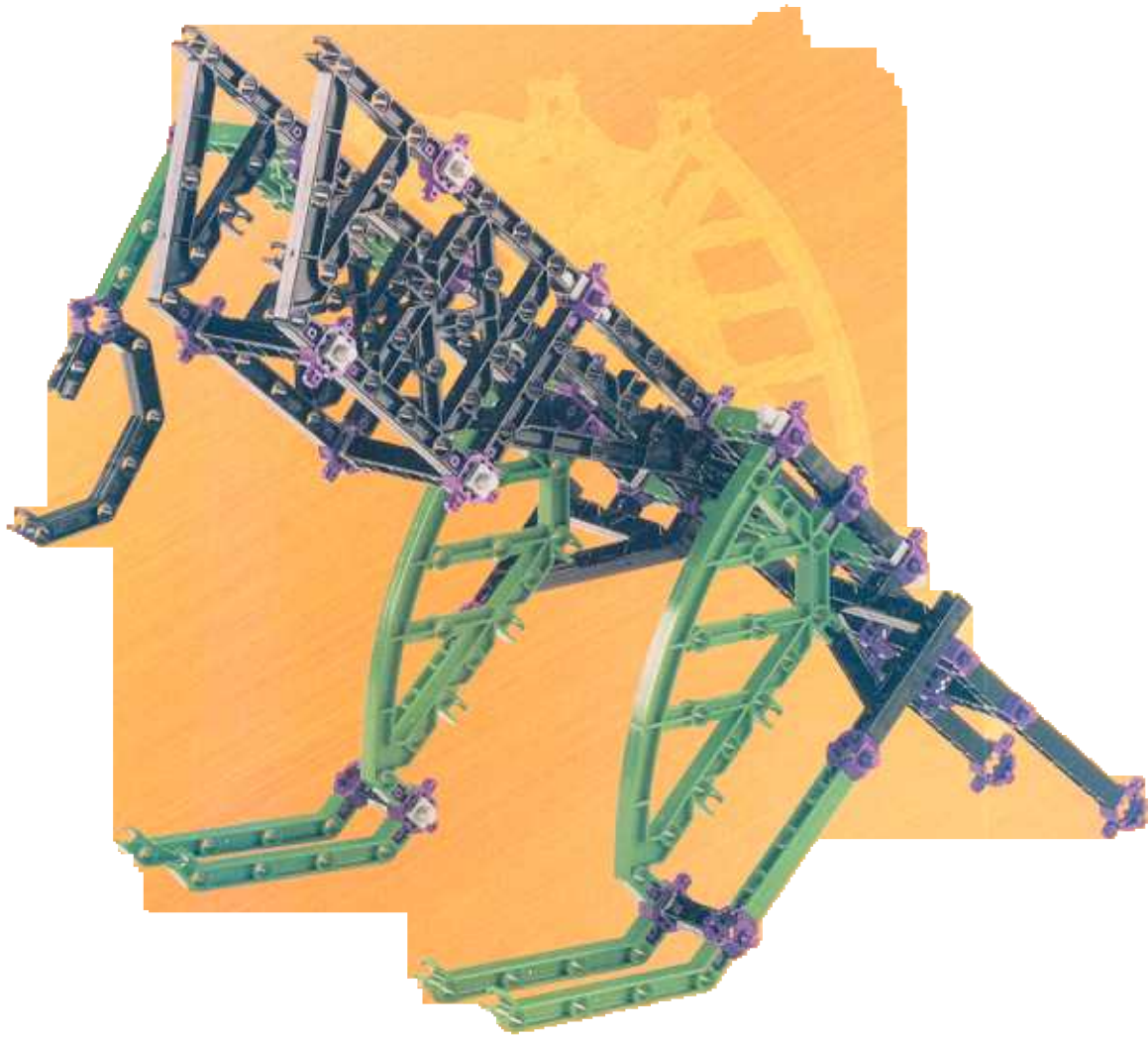

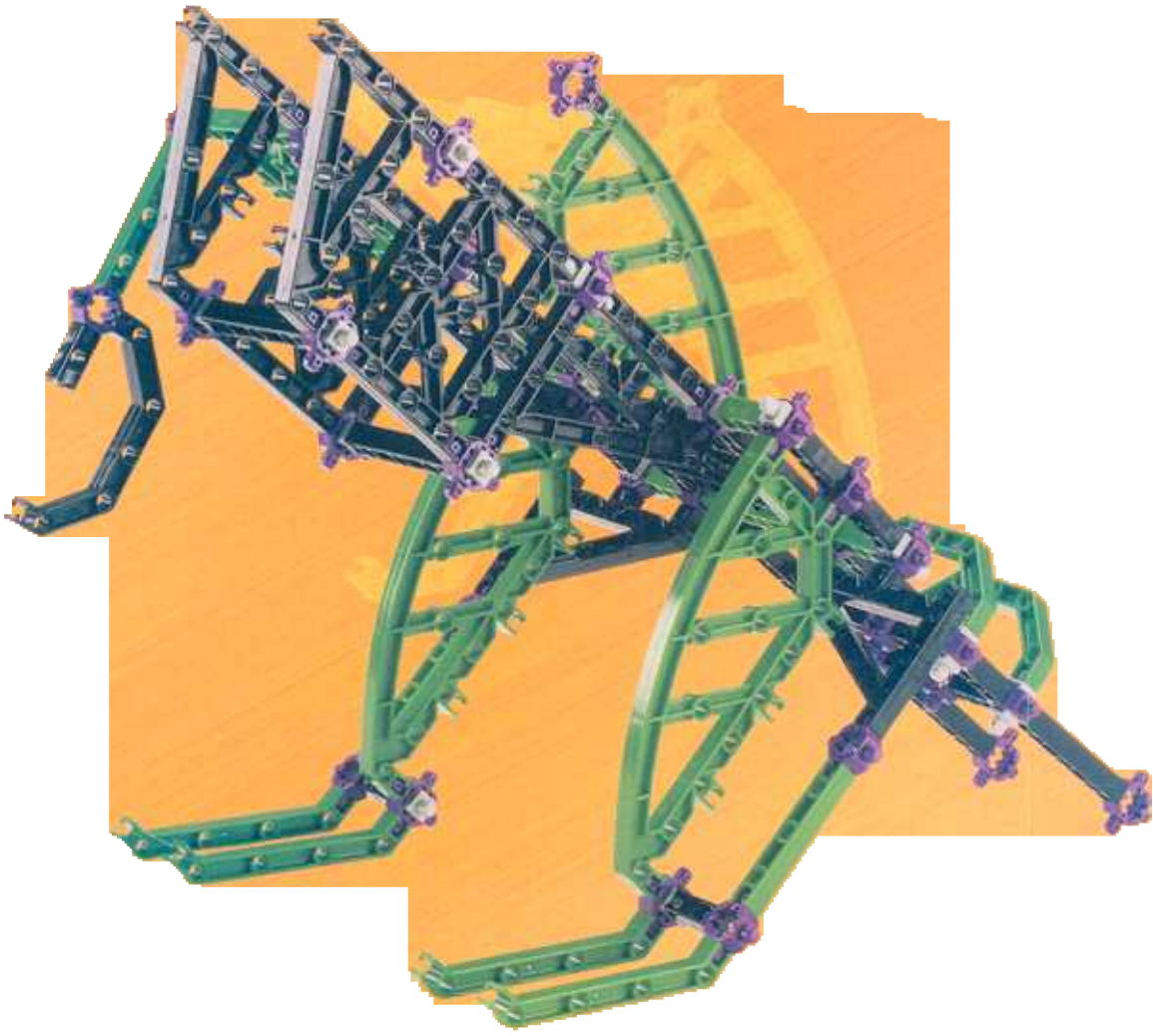

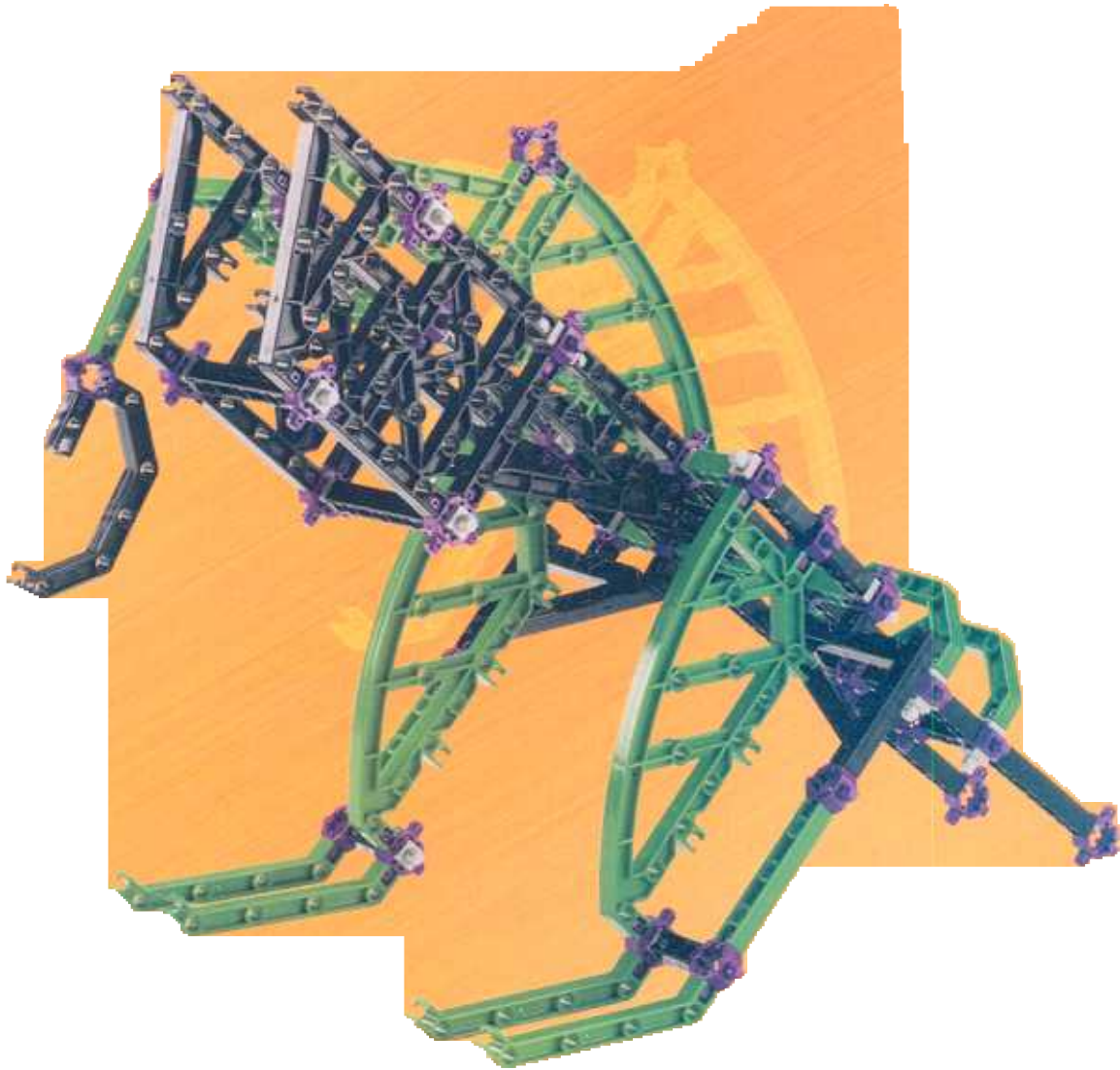

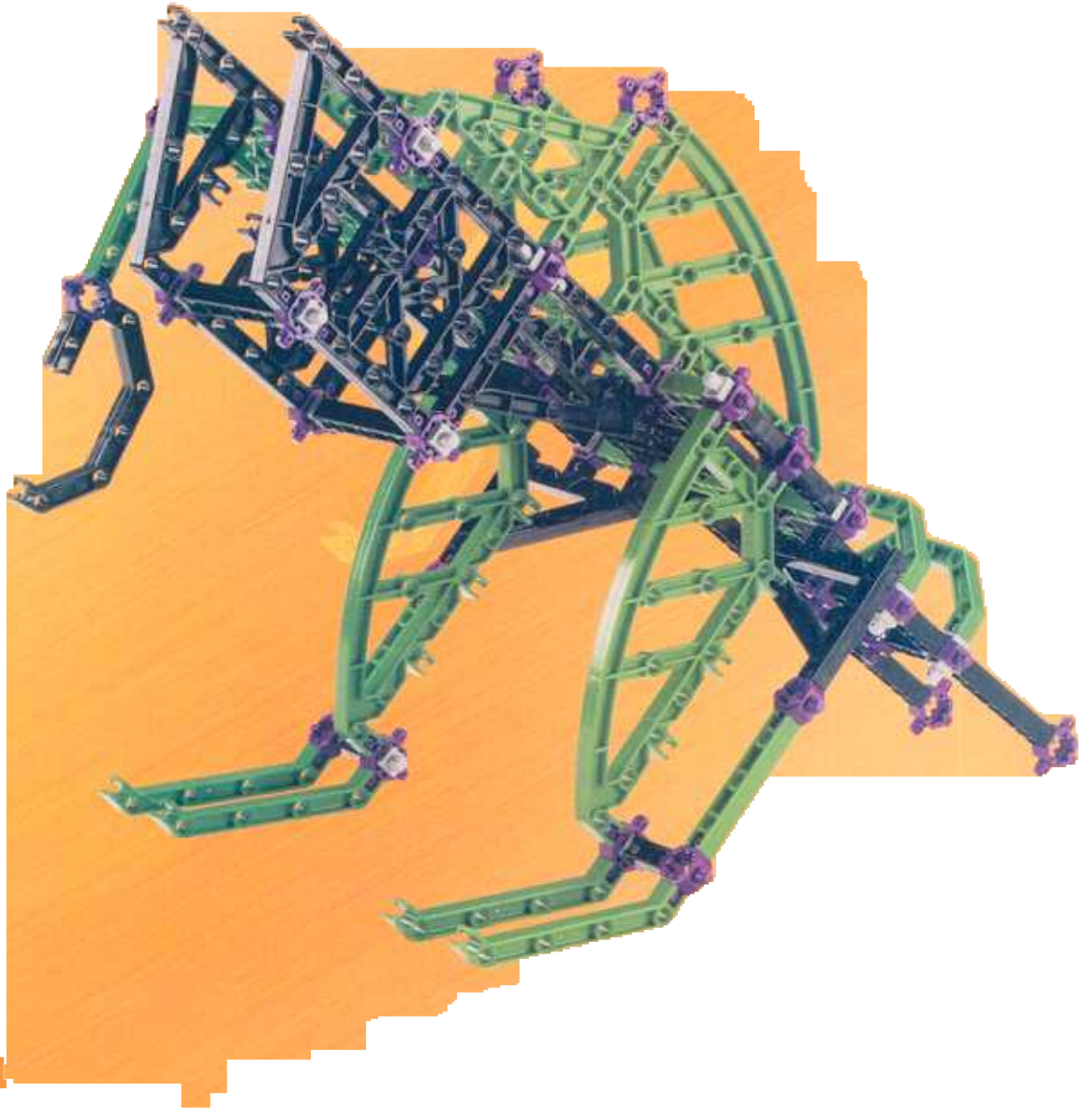

27

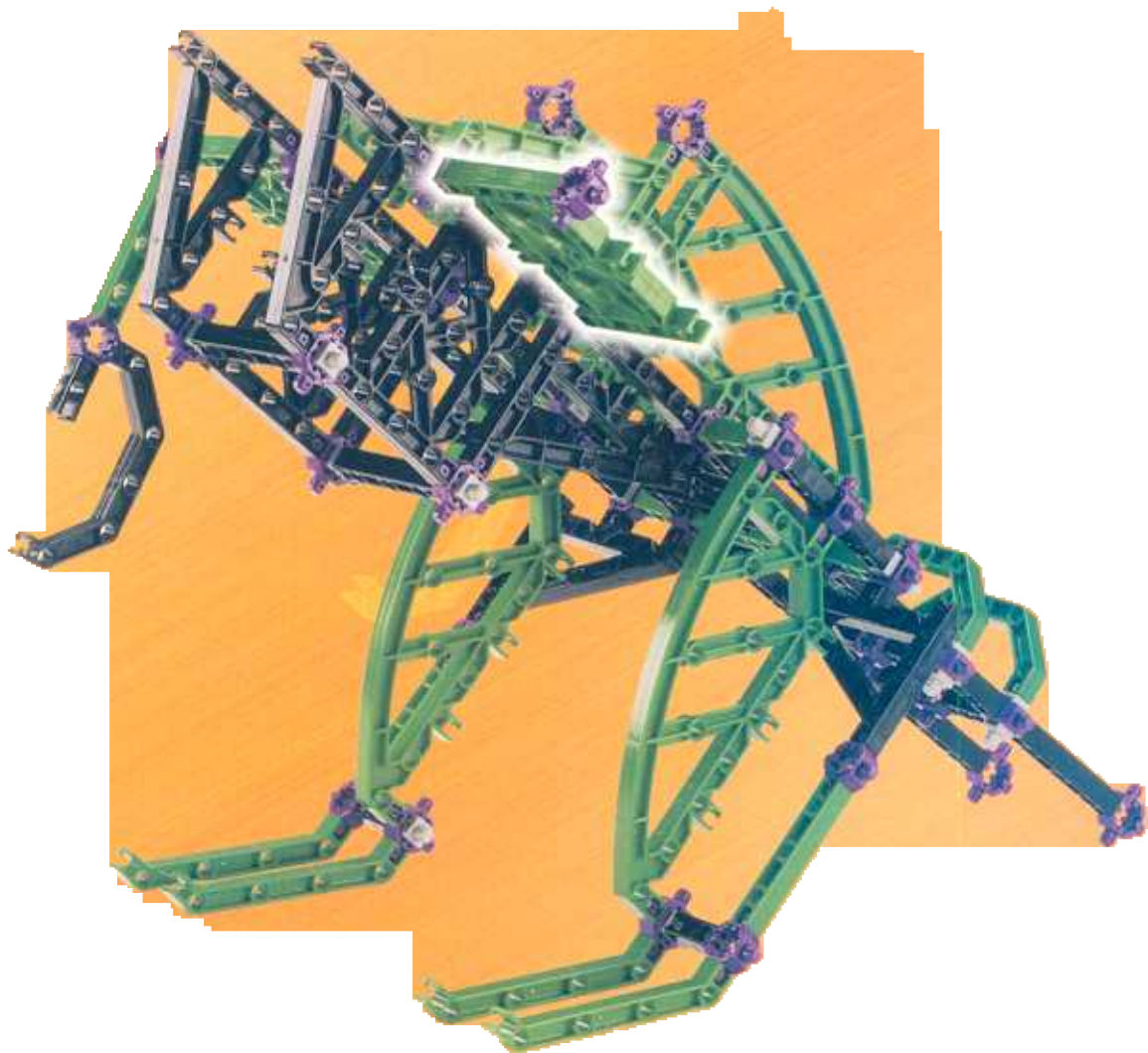

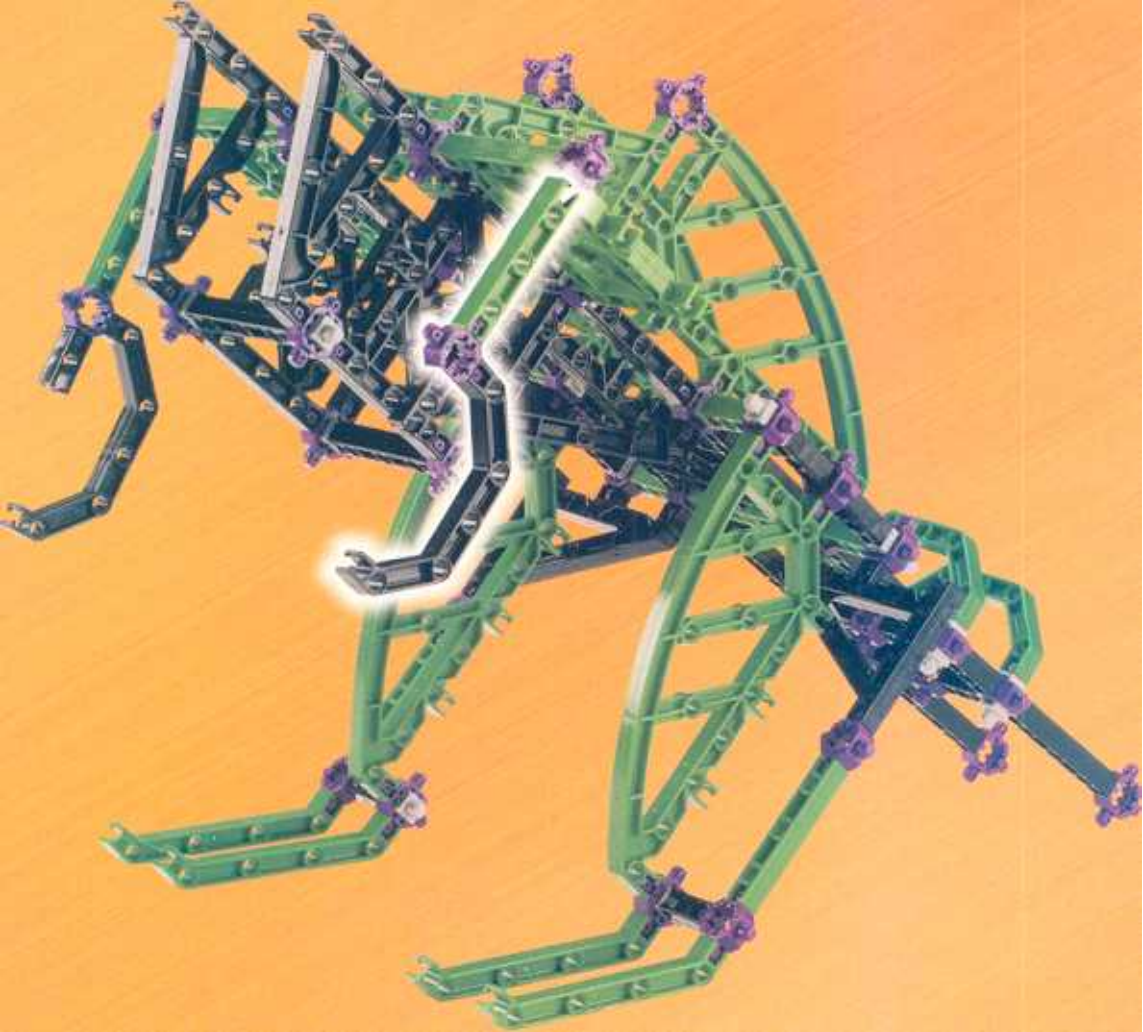

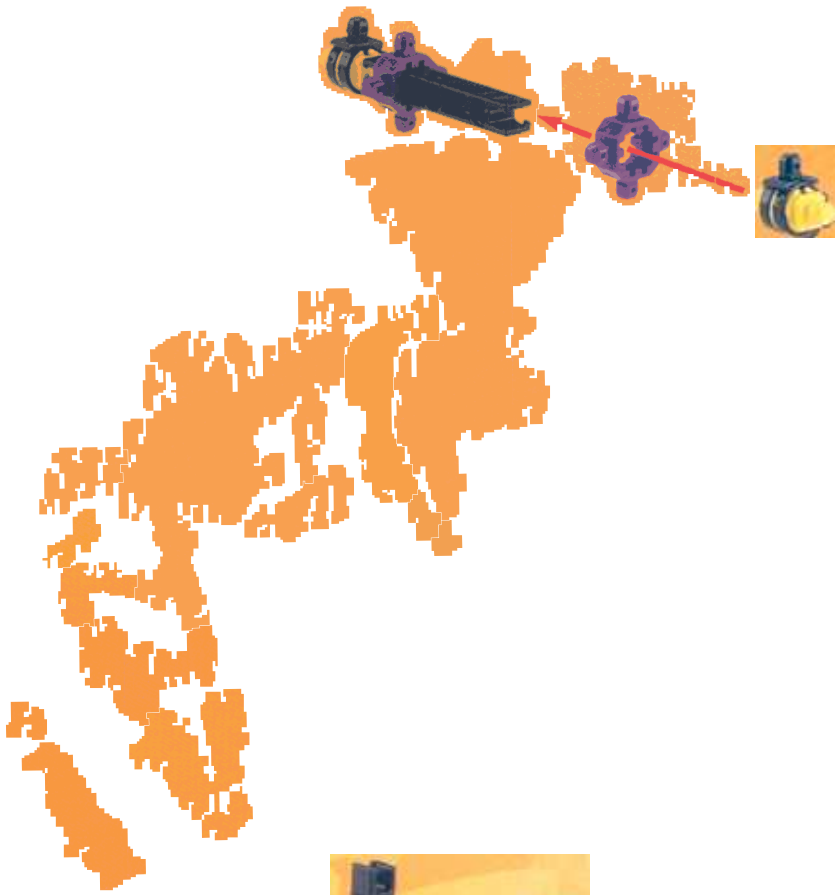

3

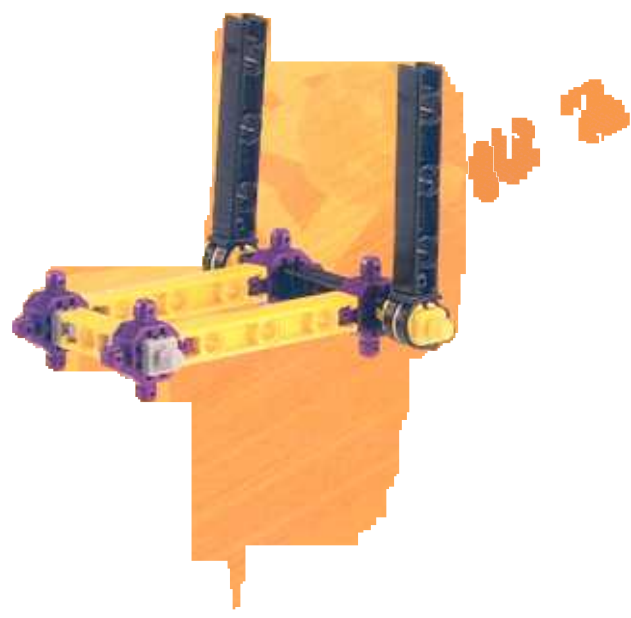

4

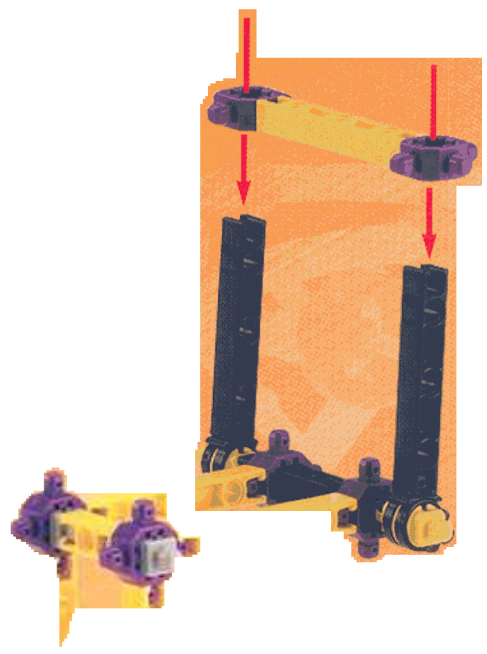

5

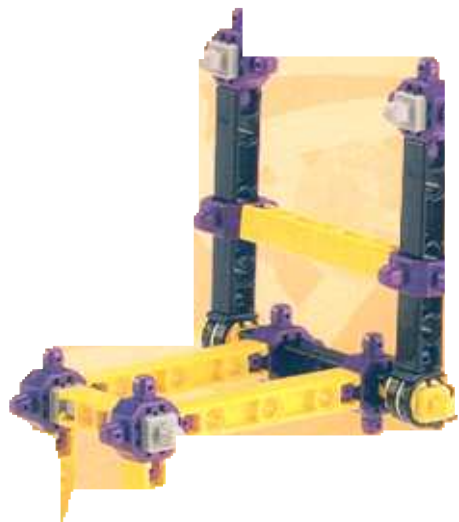

6



7

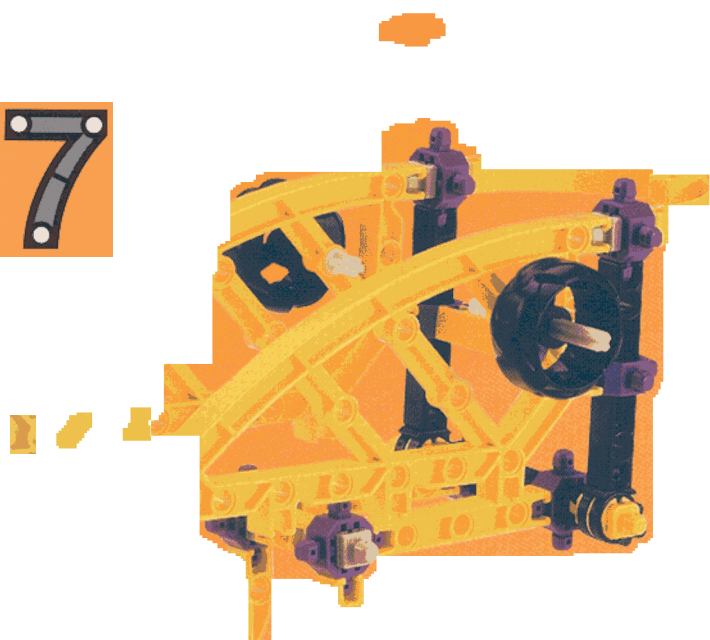

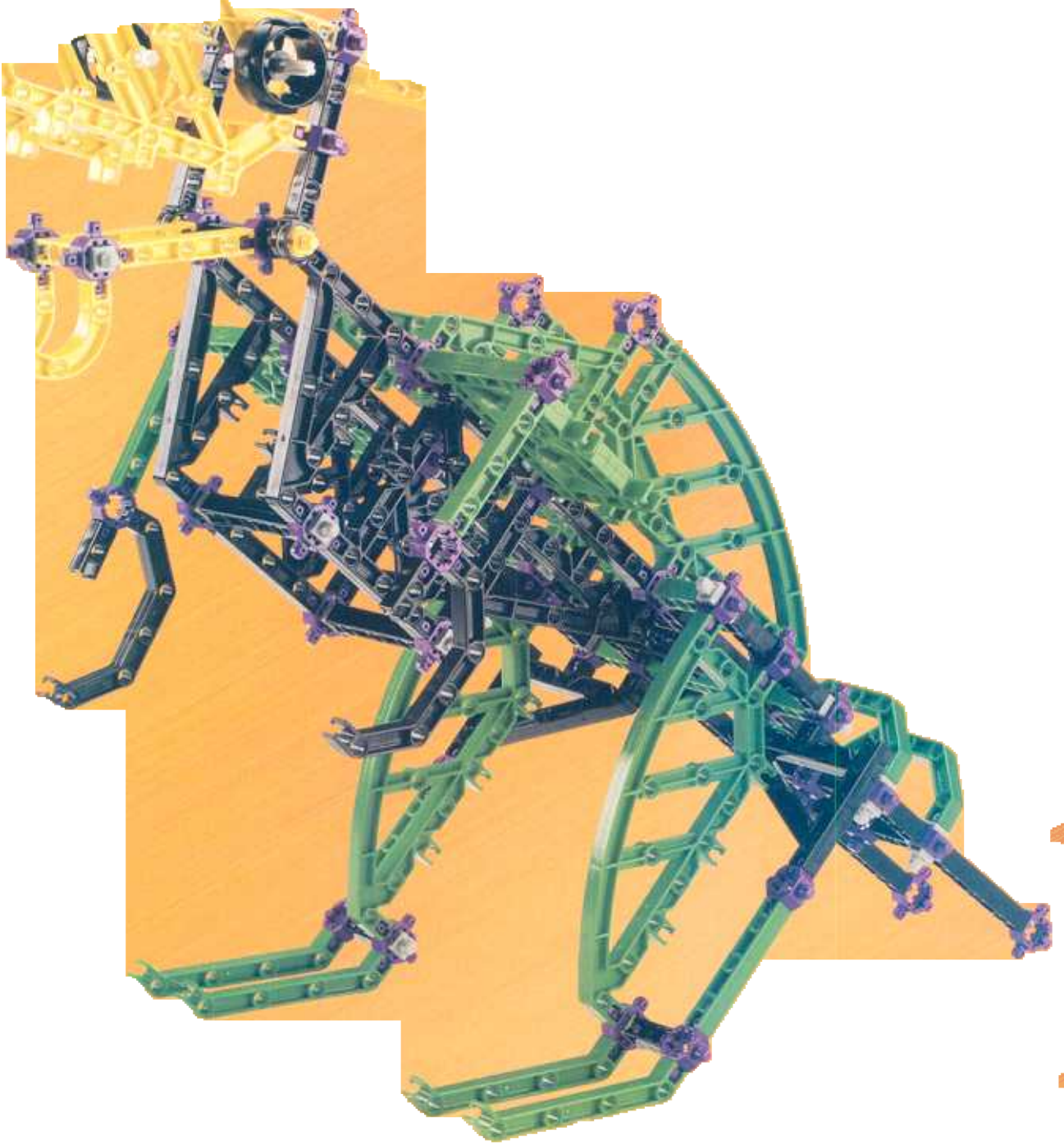



1

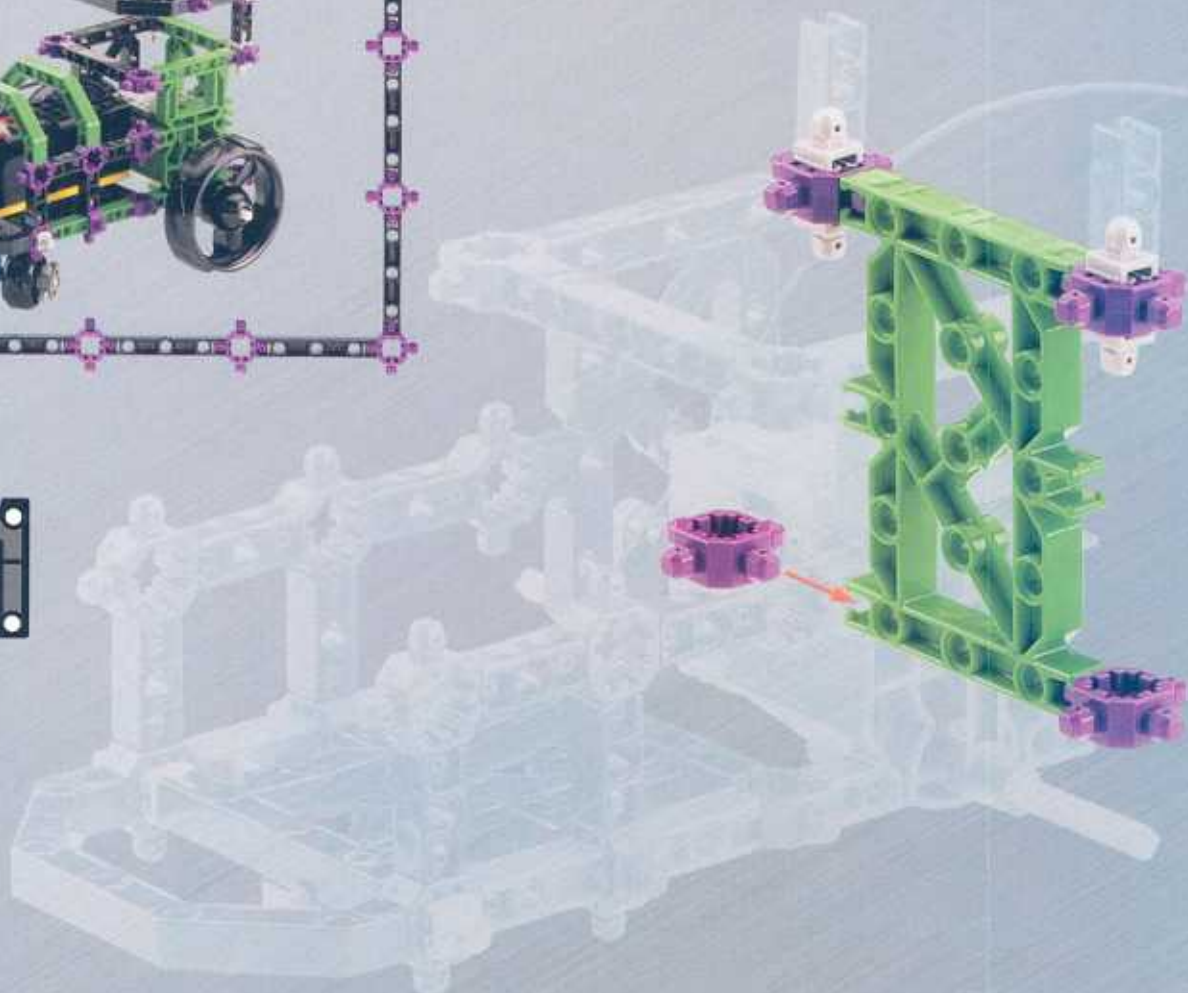

2

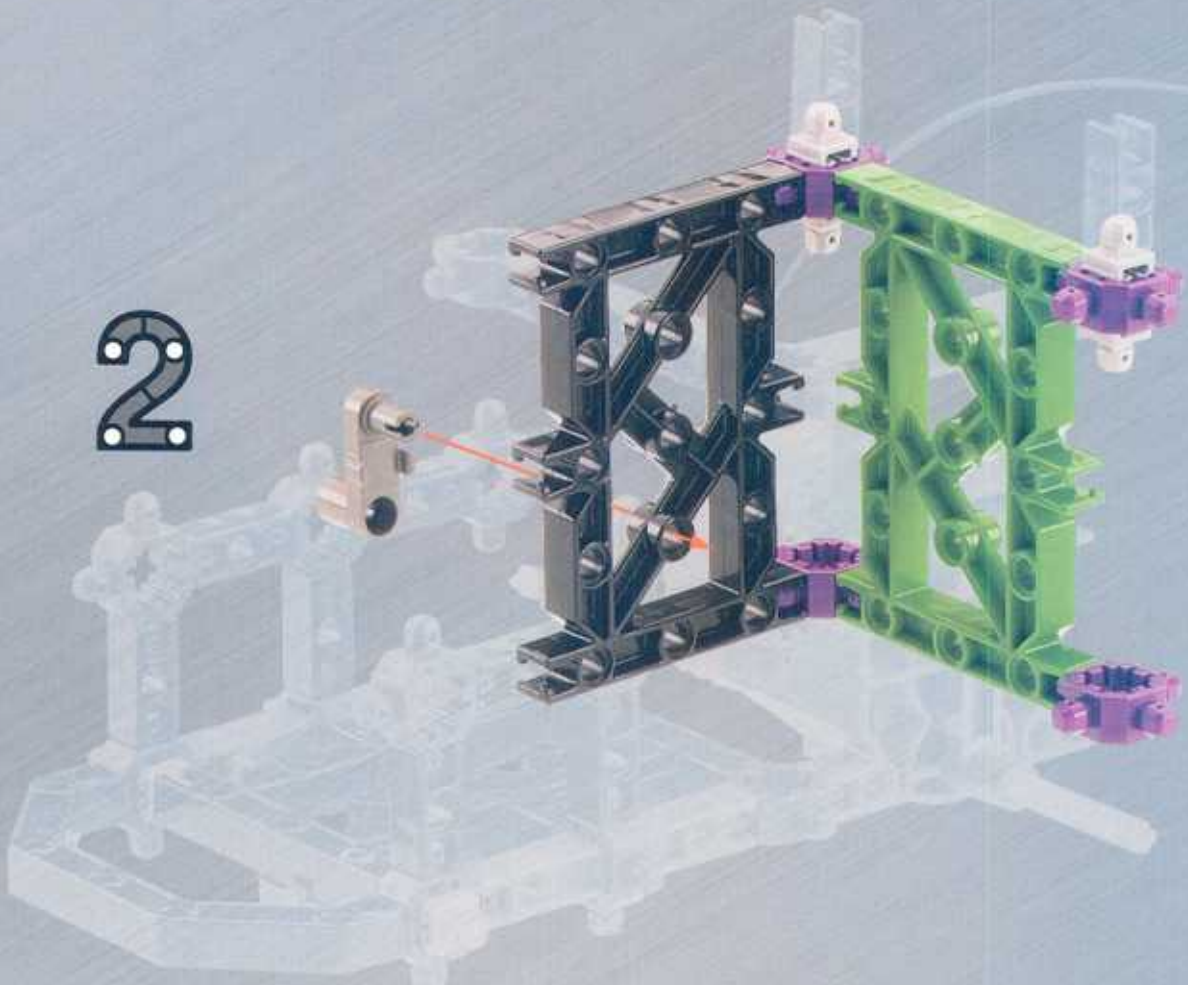



2

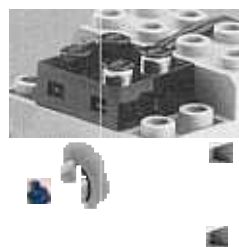
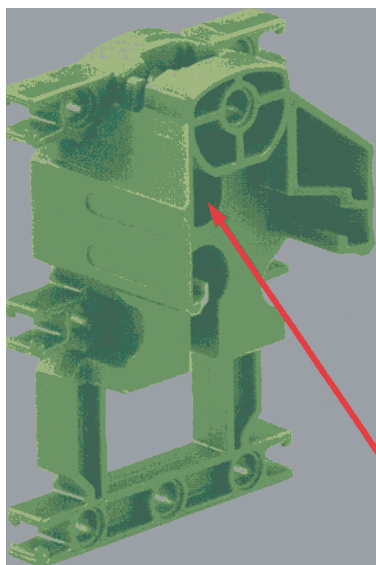

3



4

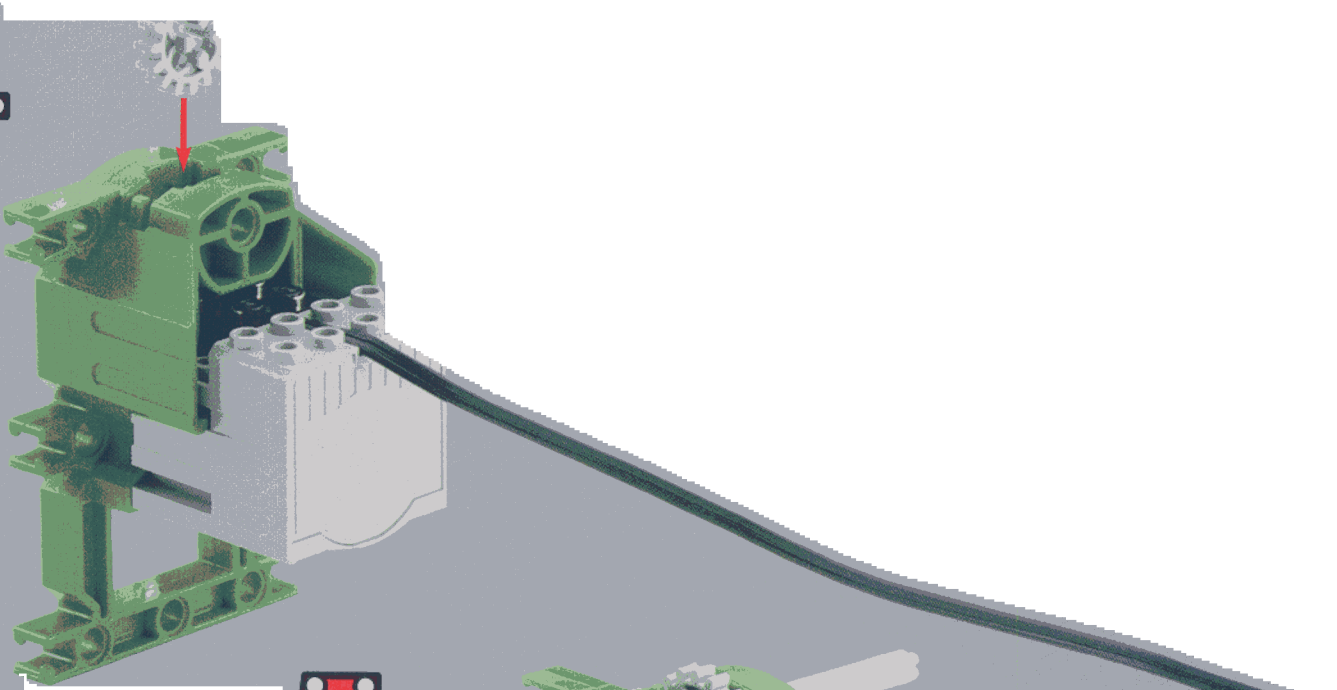

5

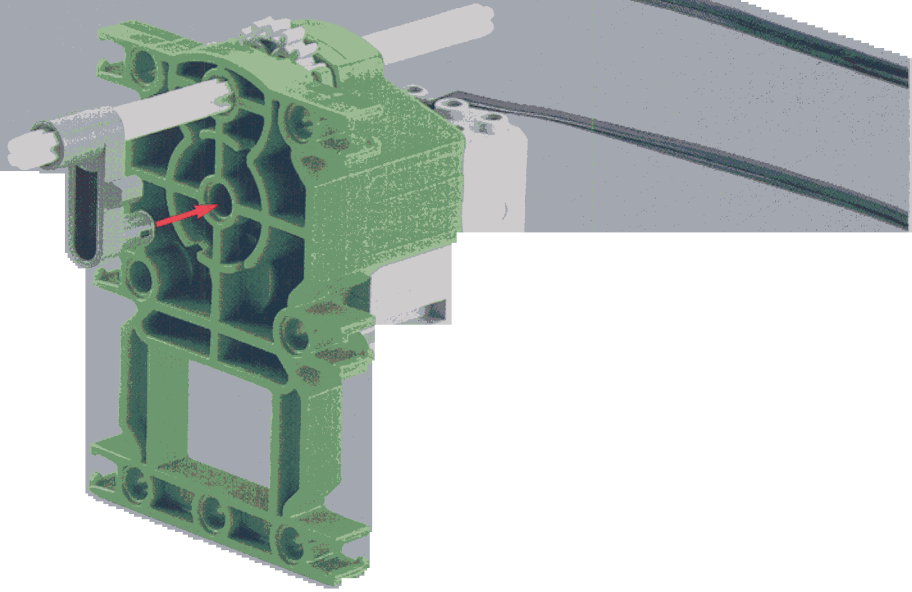

6

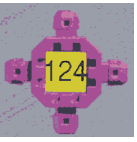

3

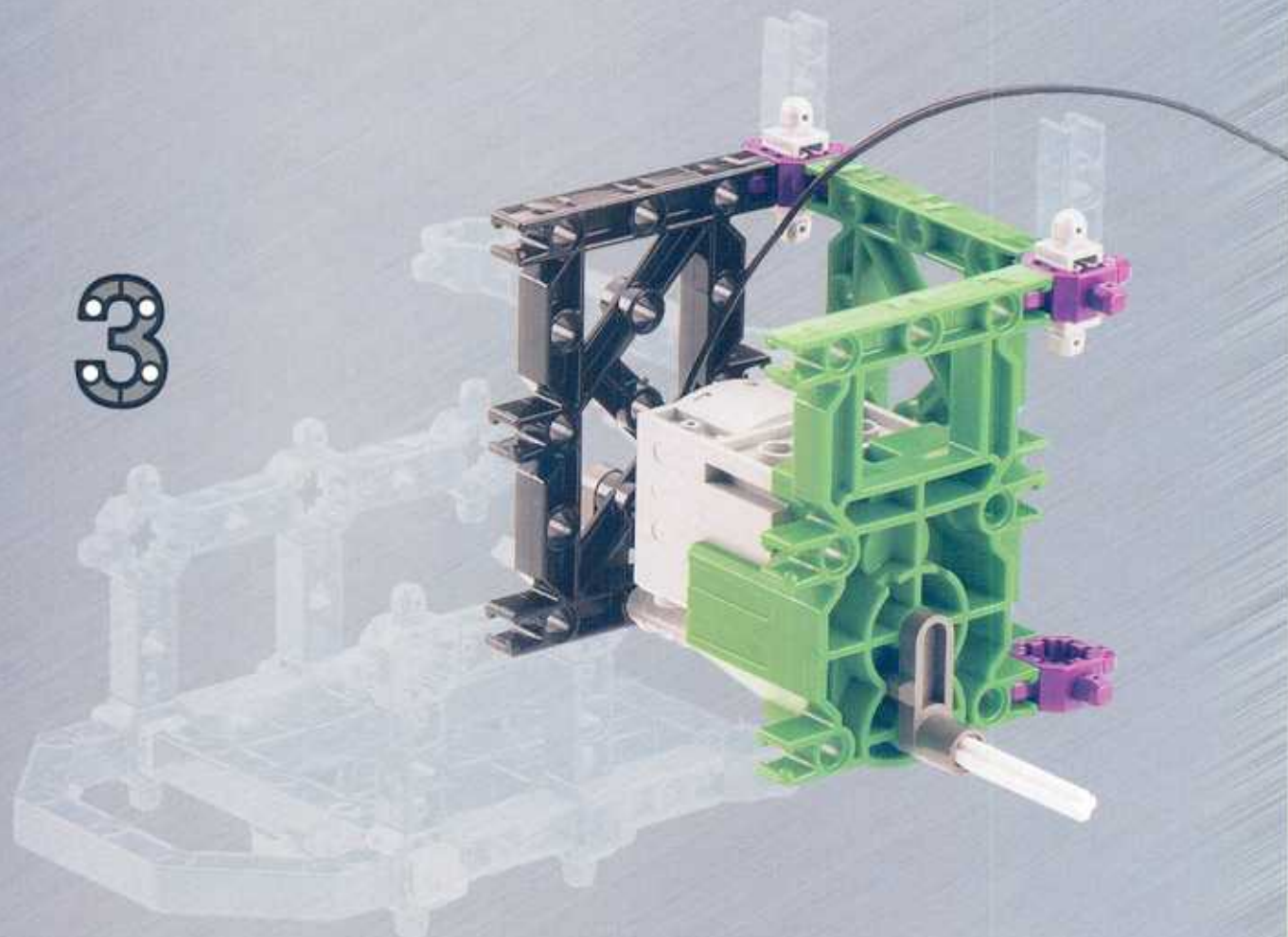

4

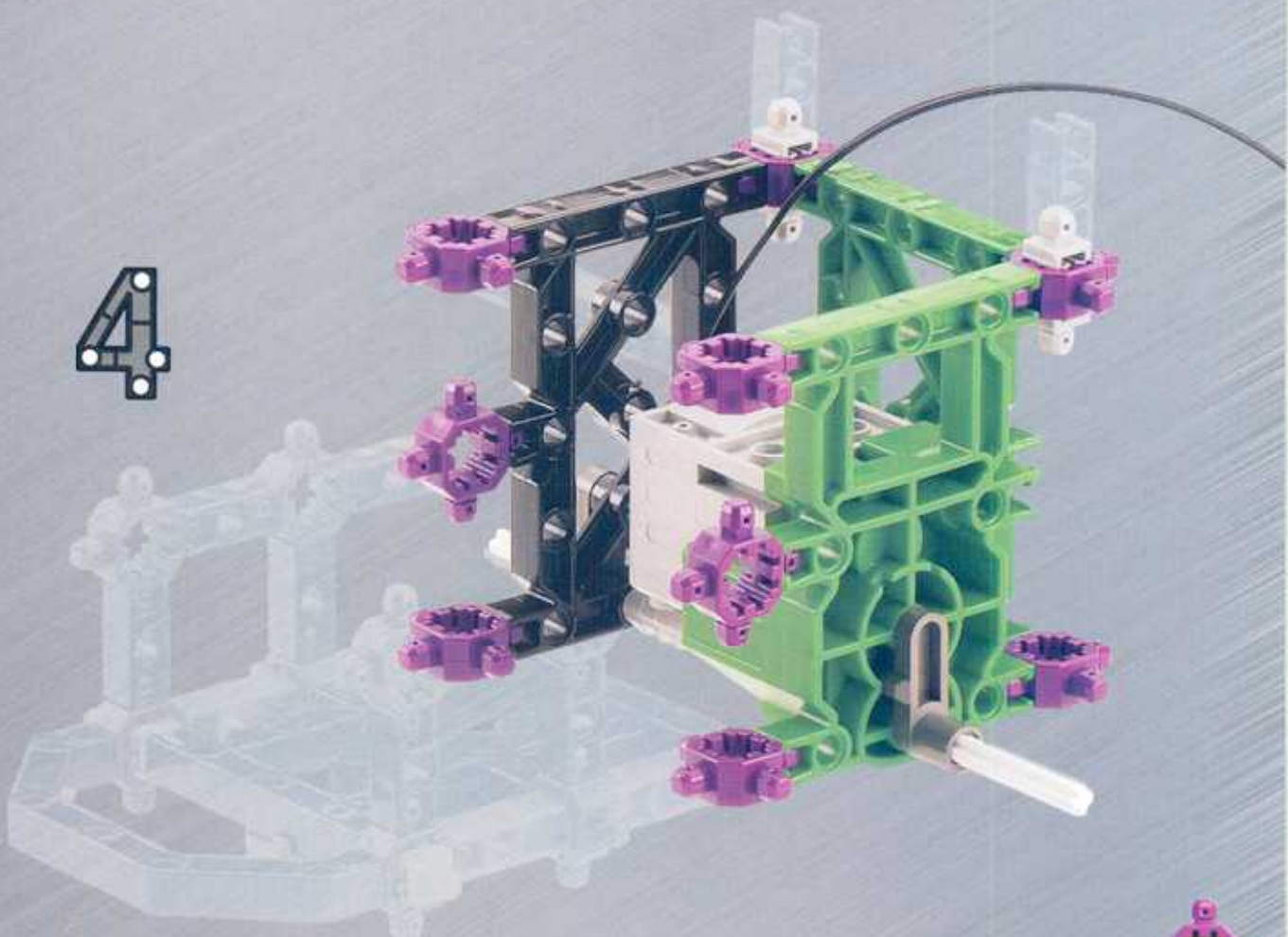

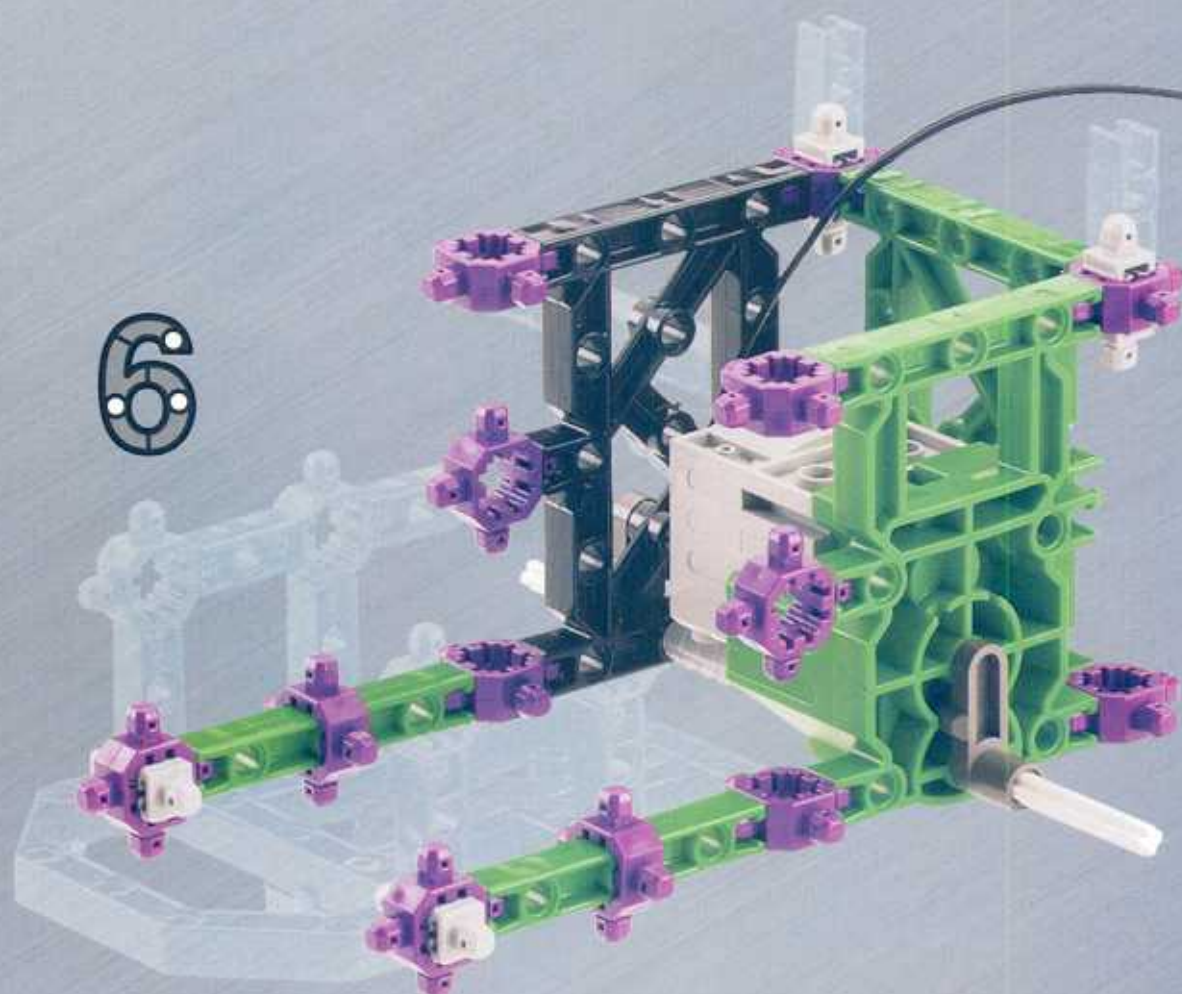
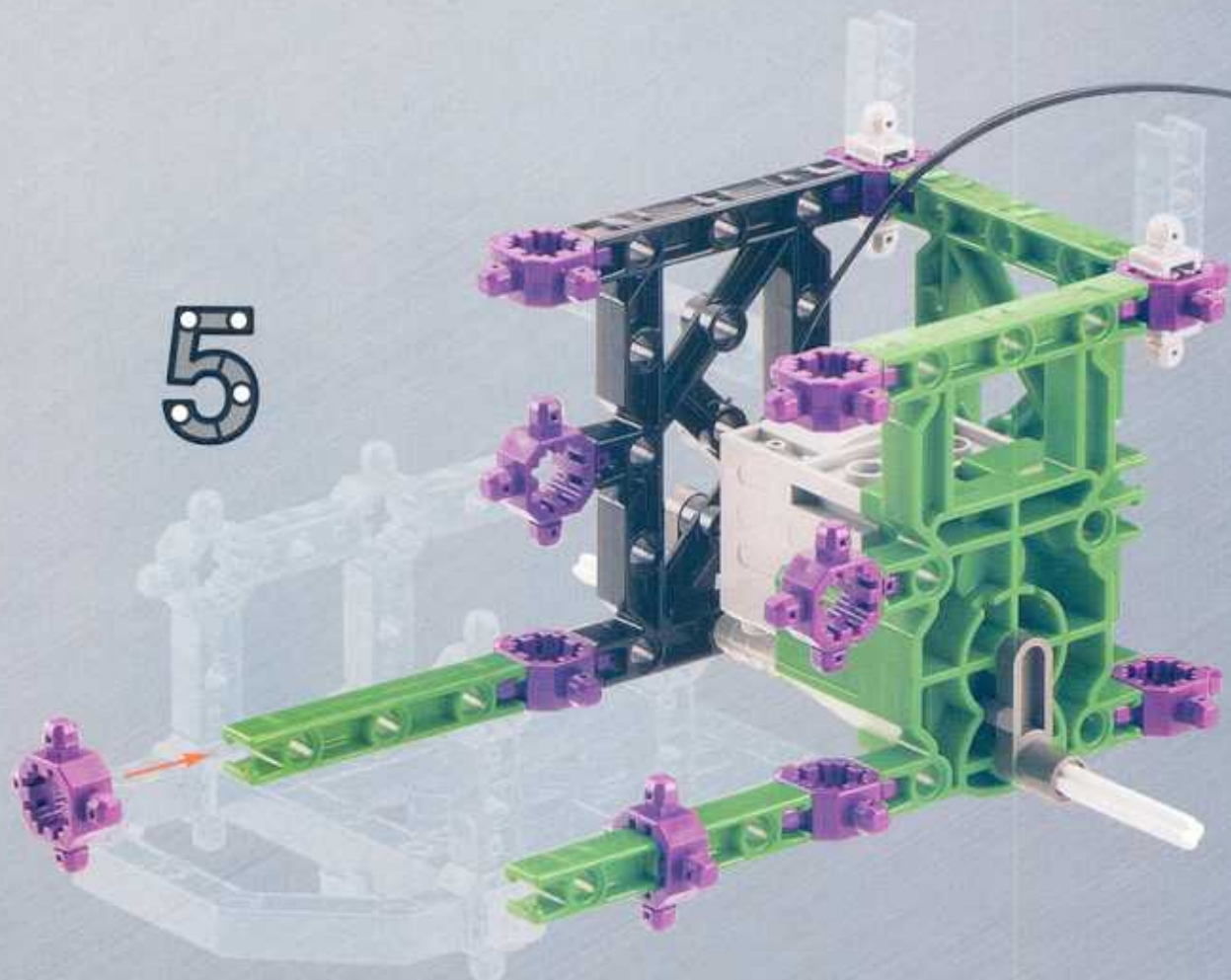

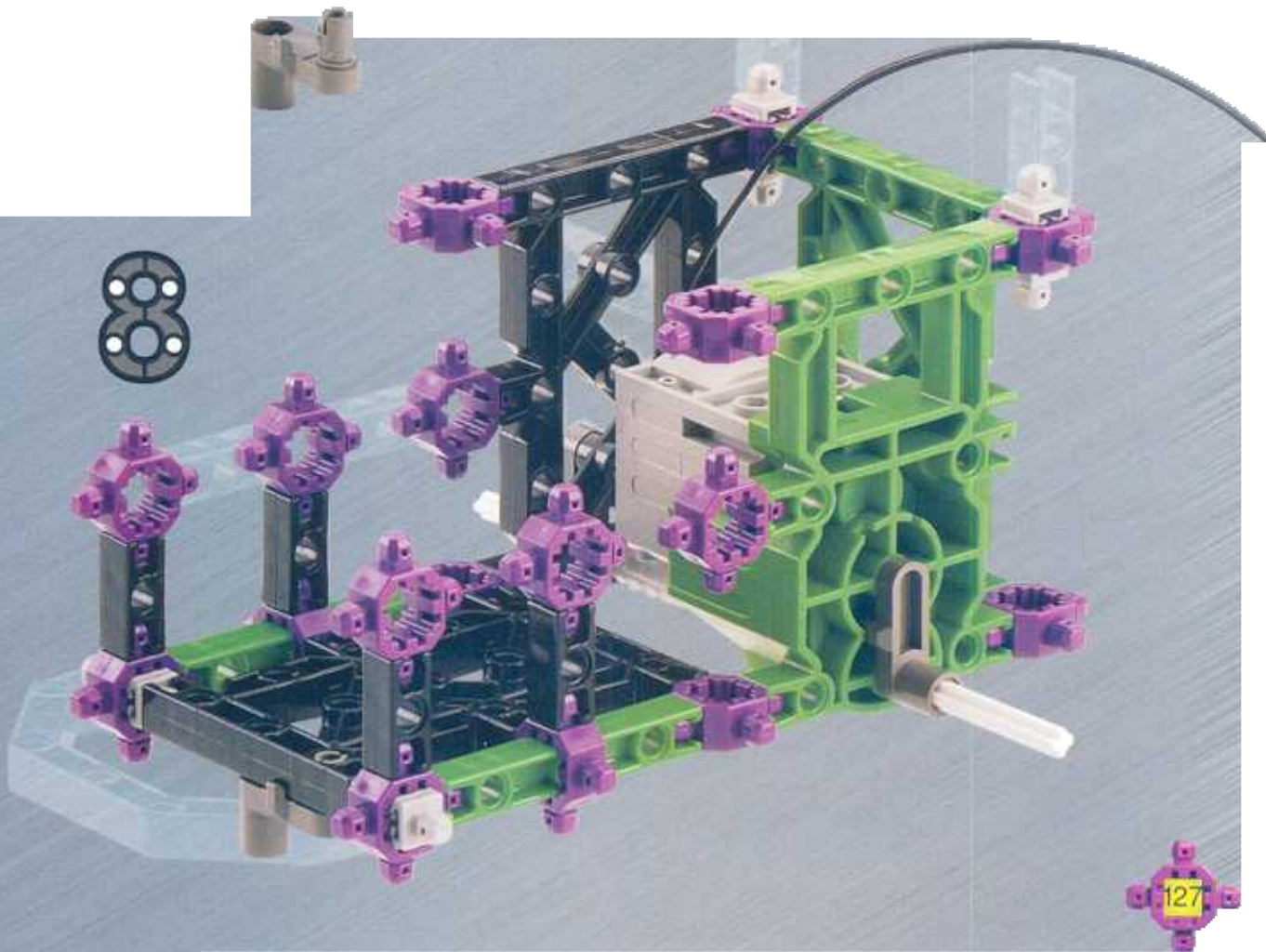
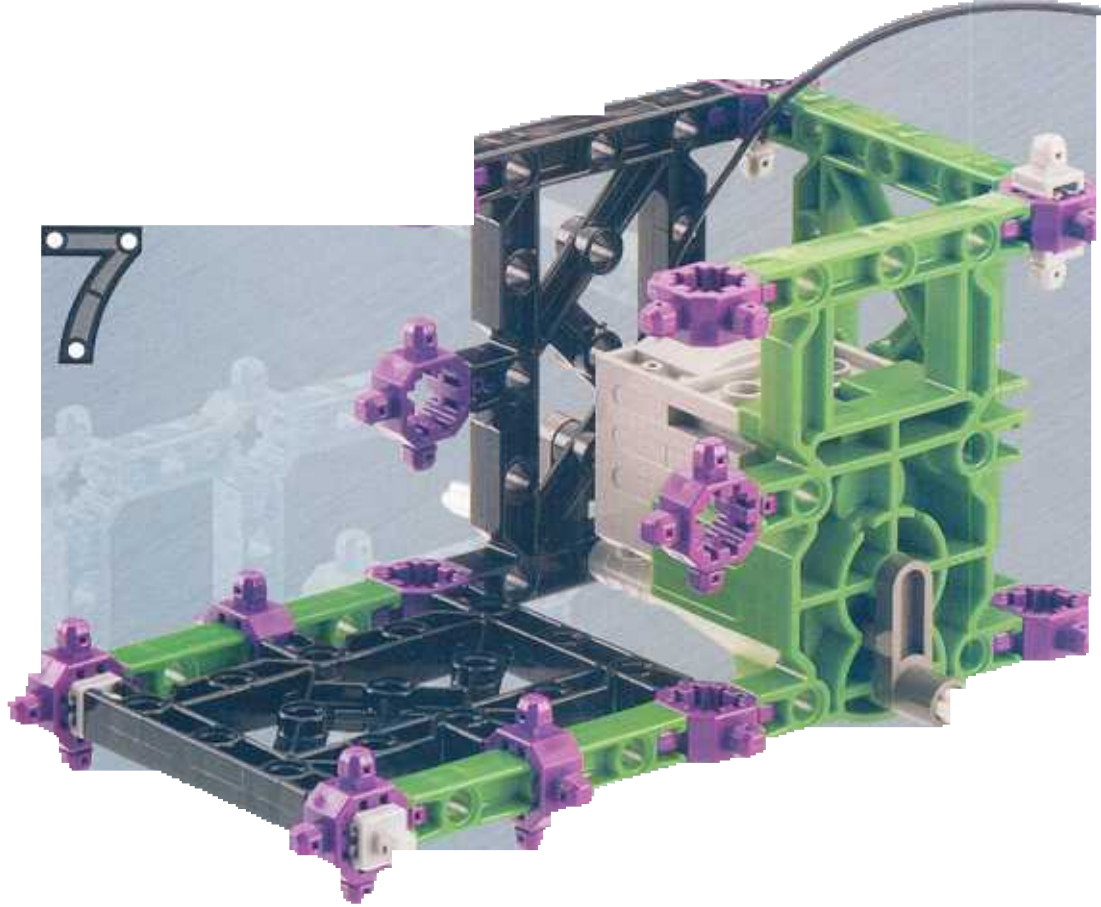

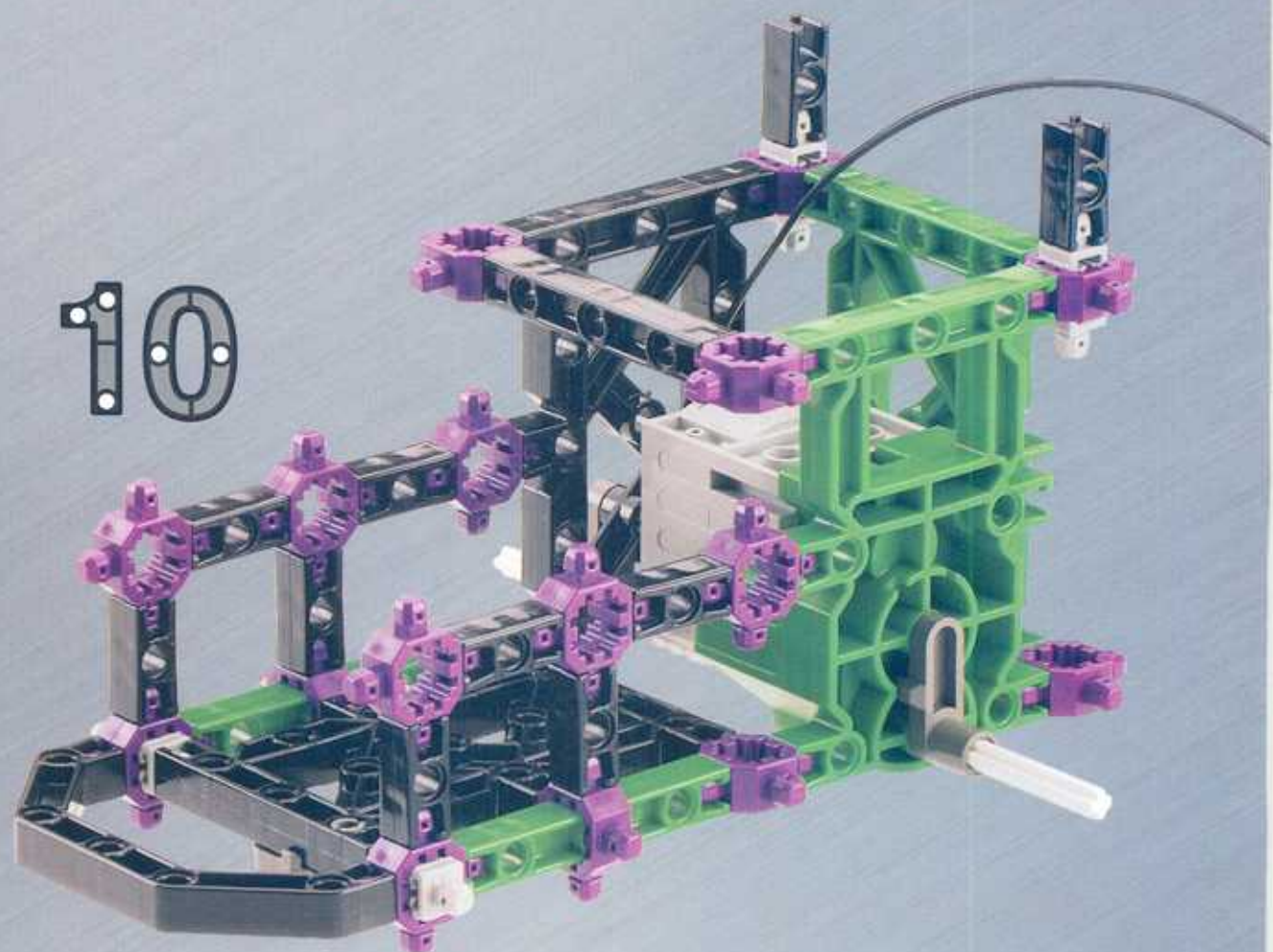
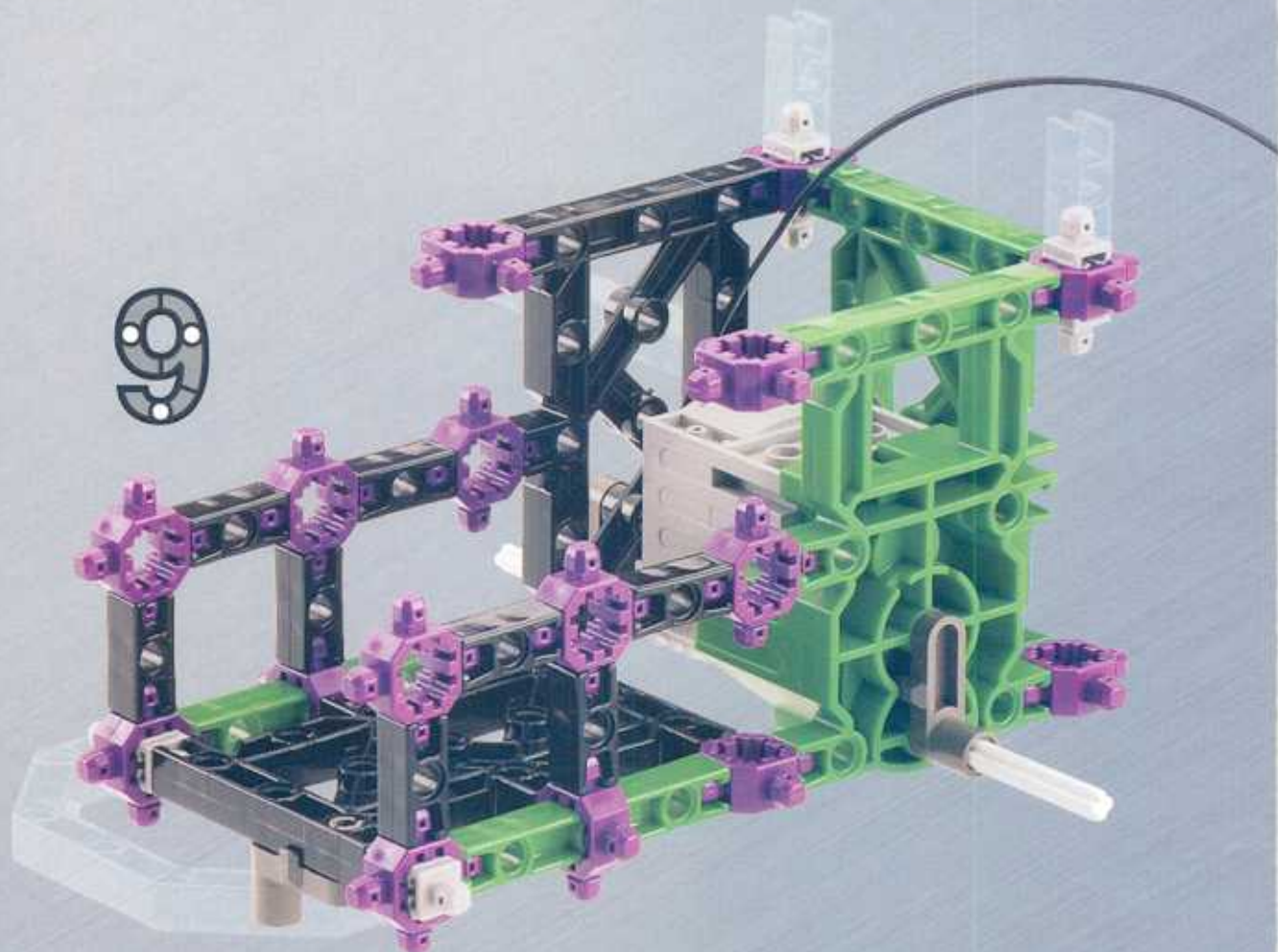

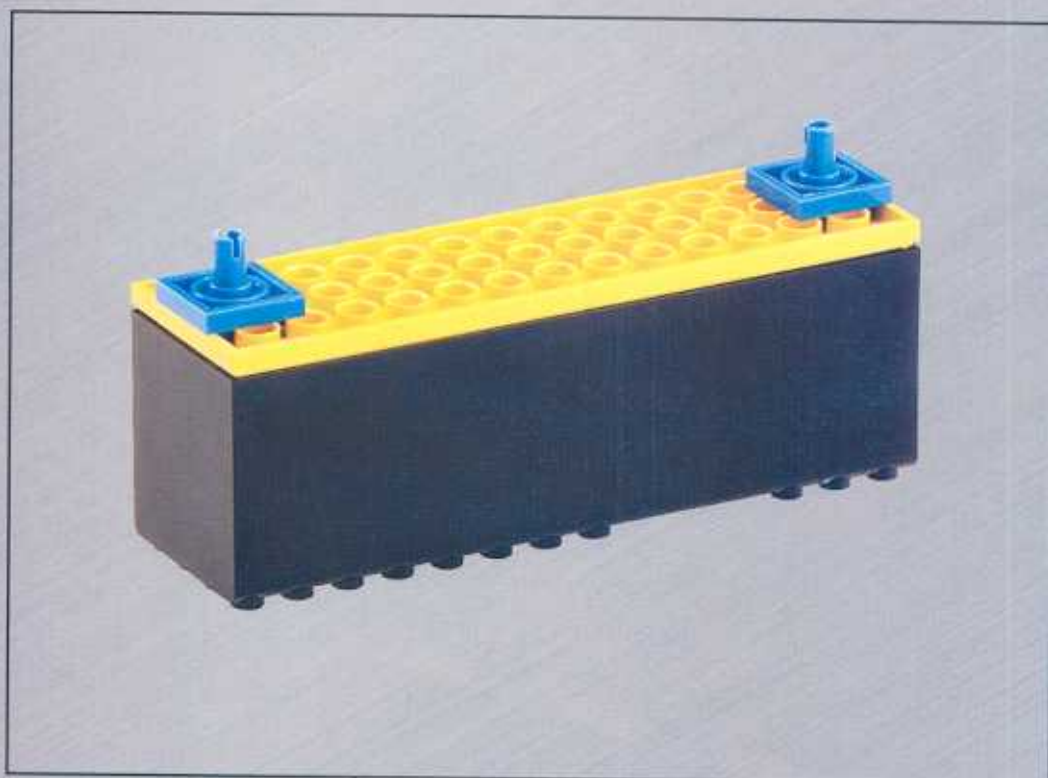

1 1

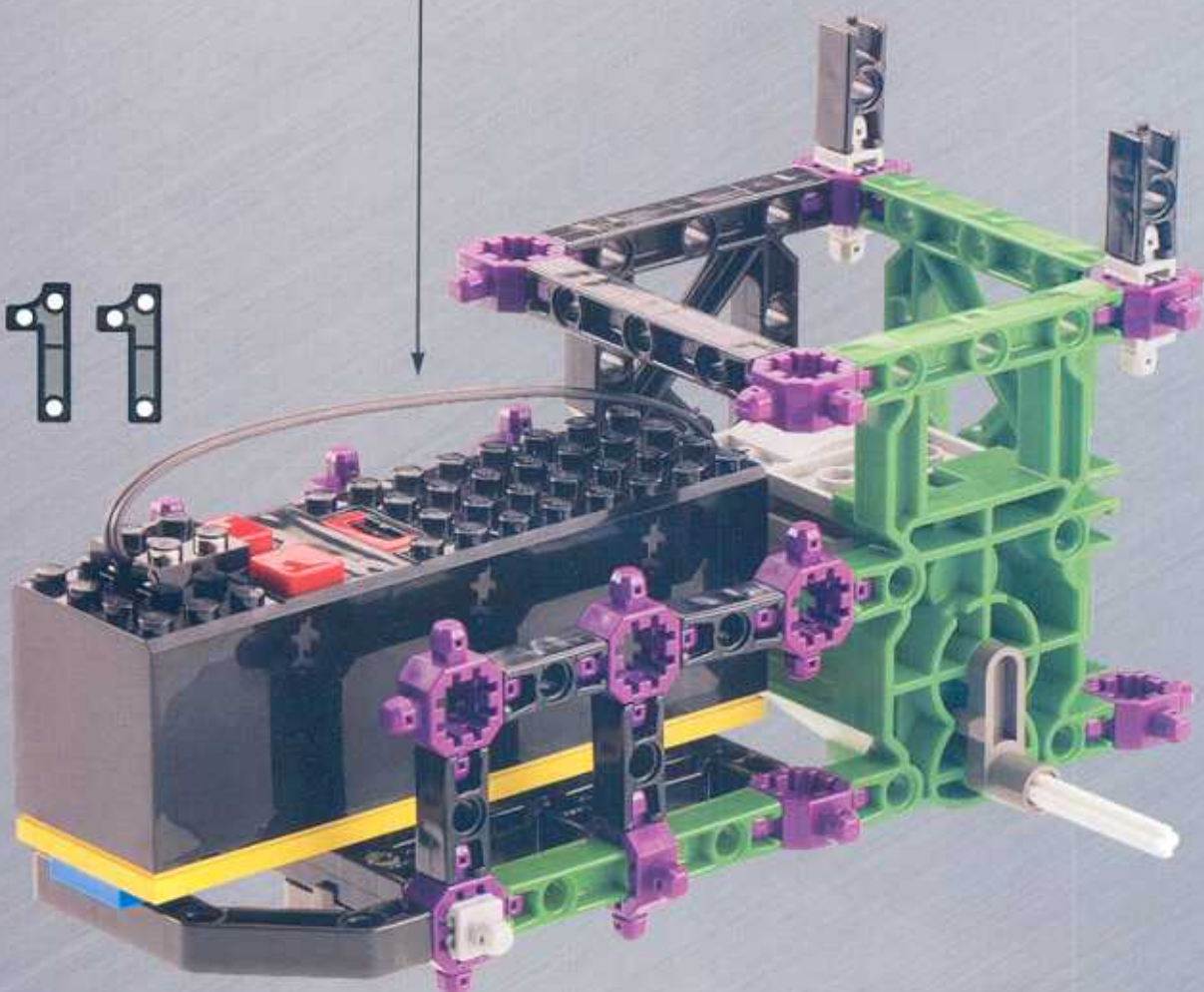

12

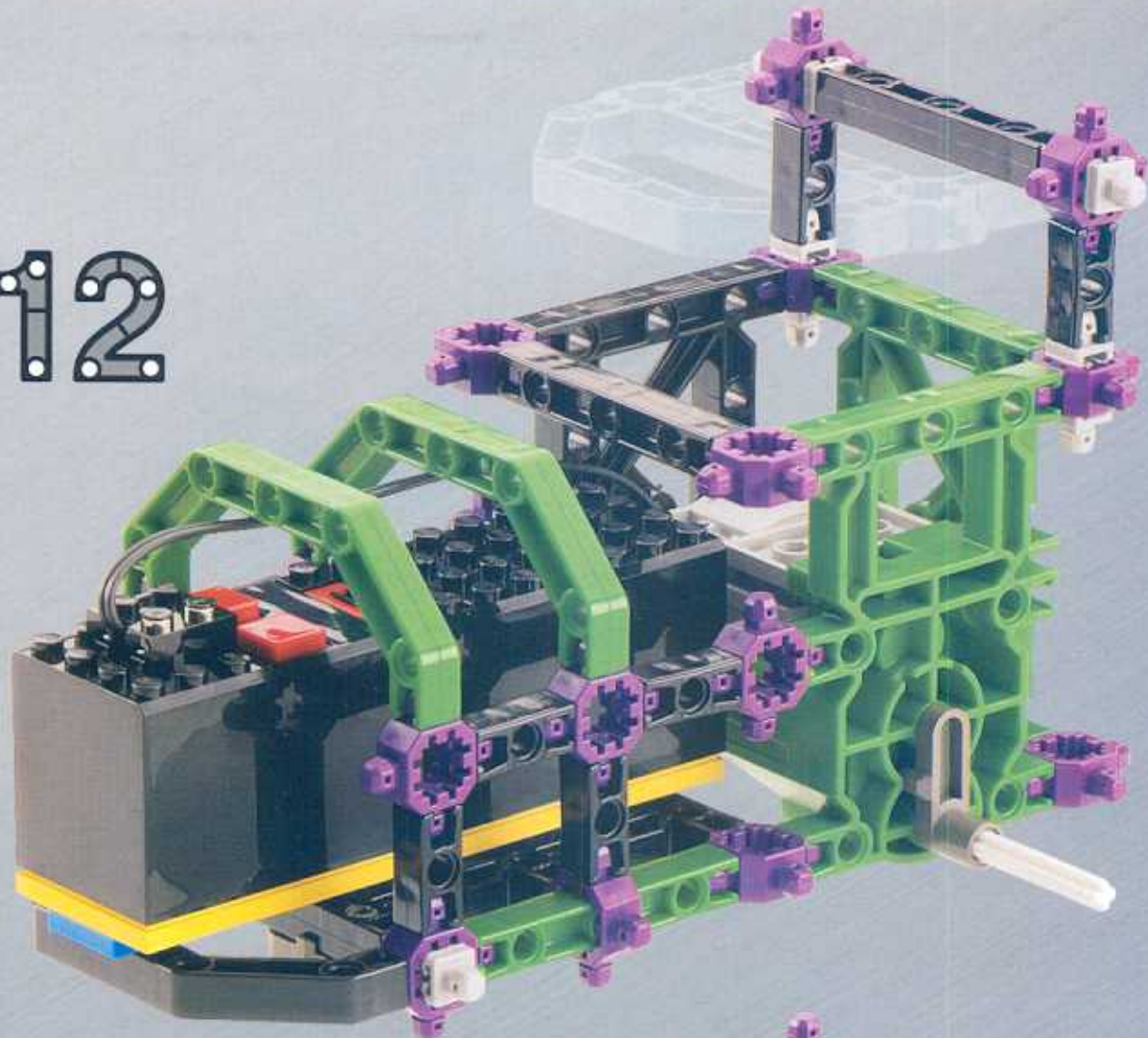

13

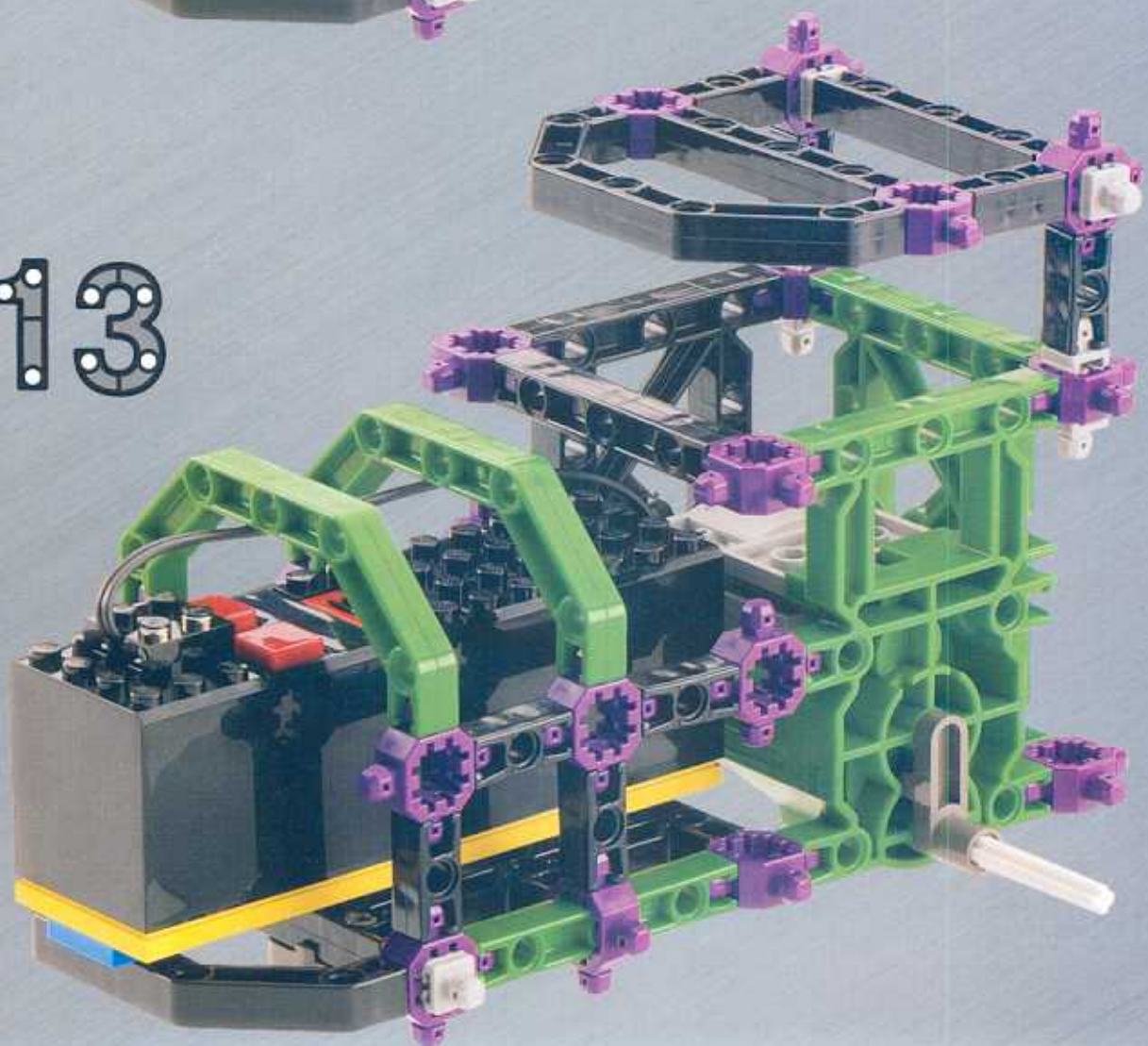

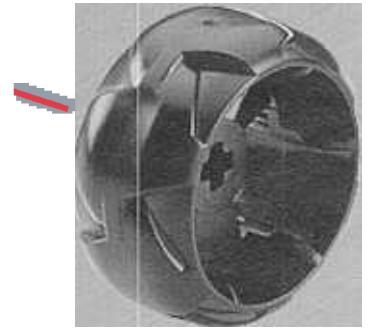
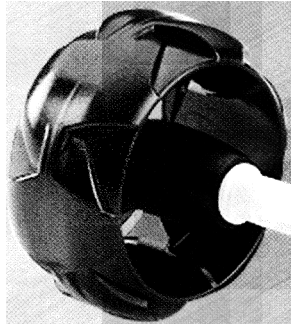

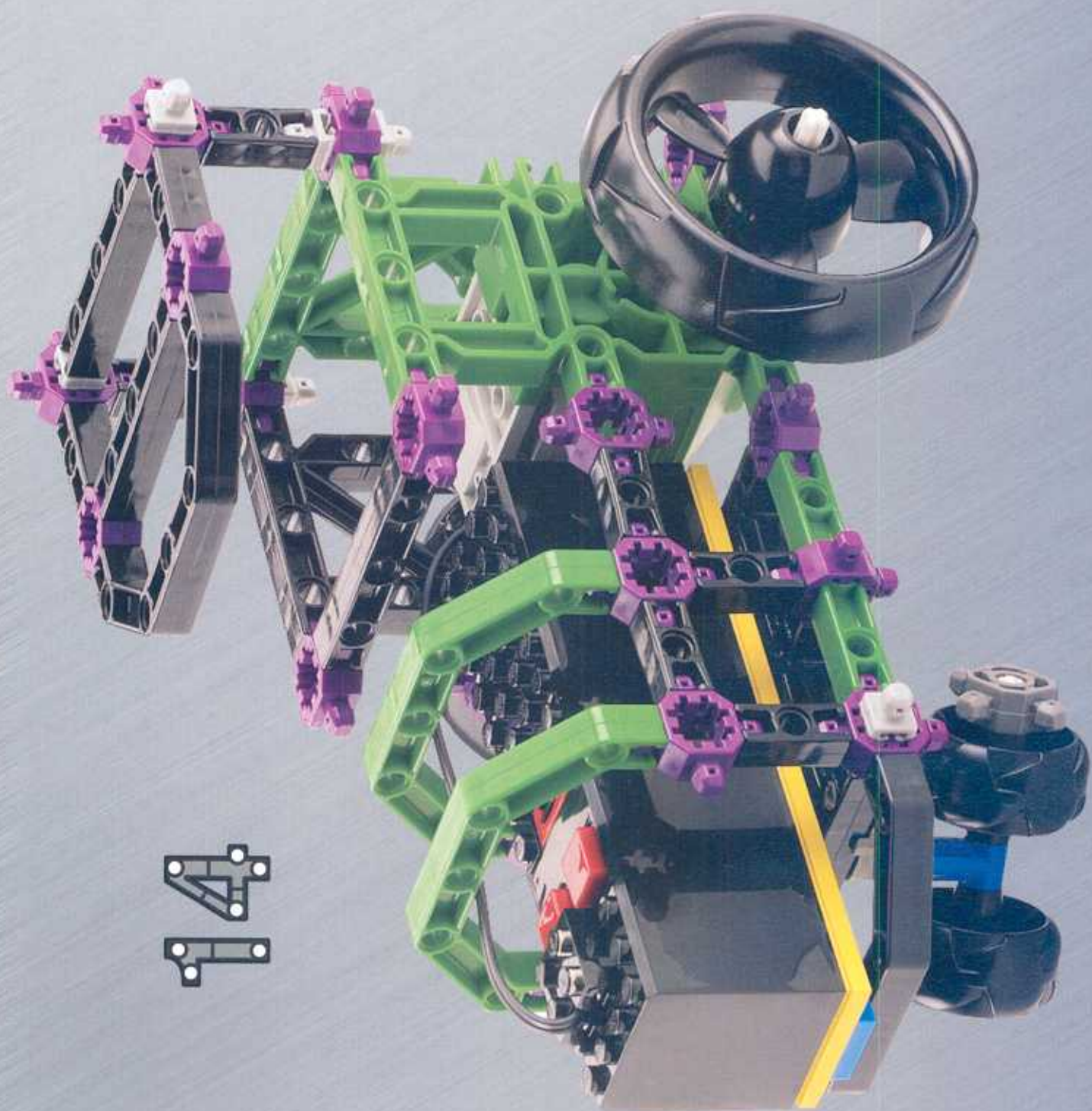

14

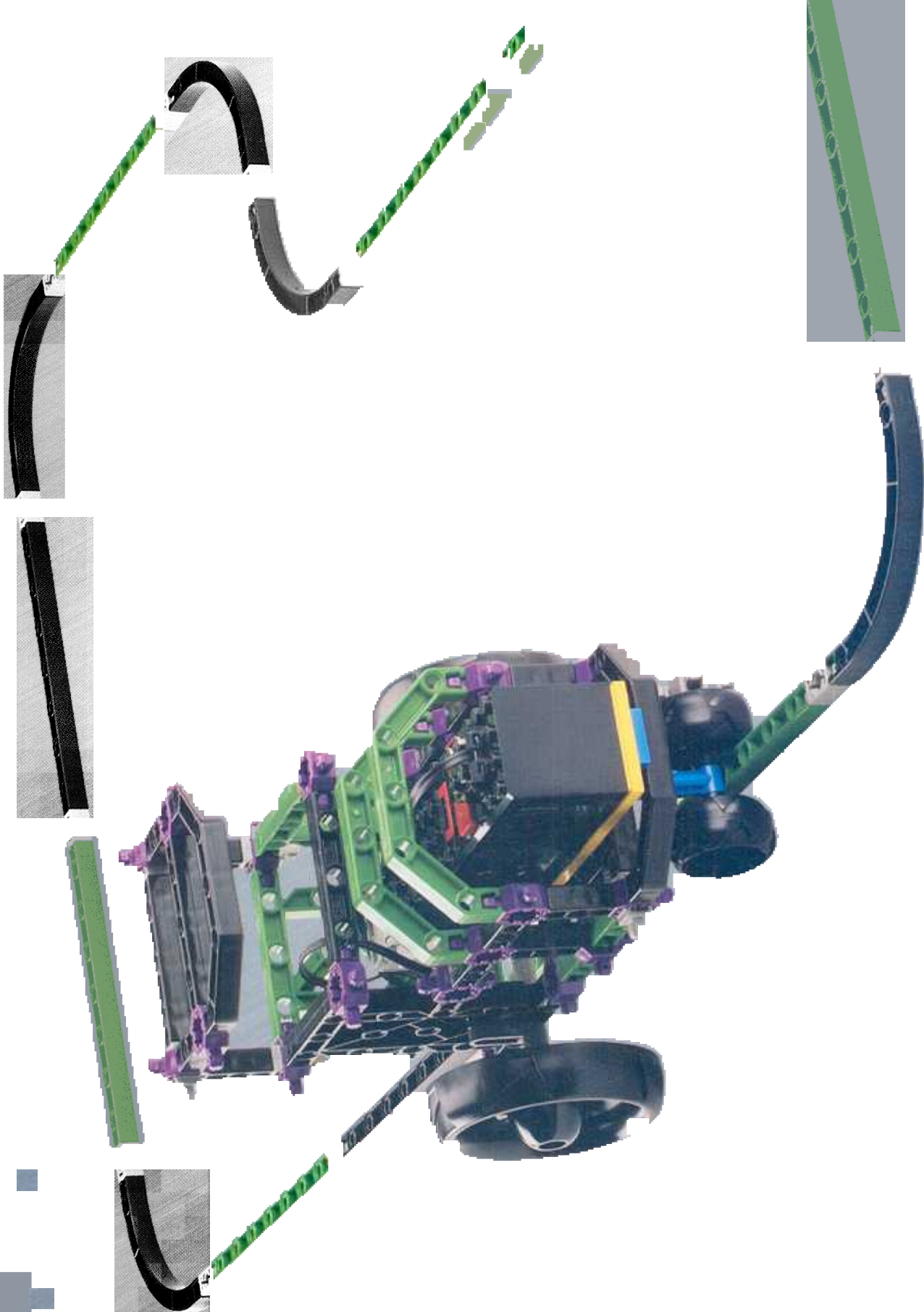



1

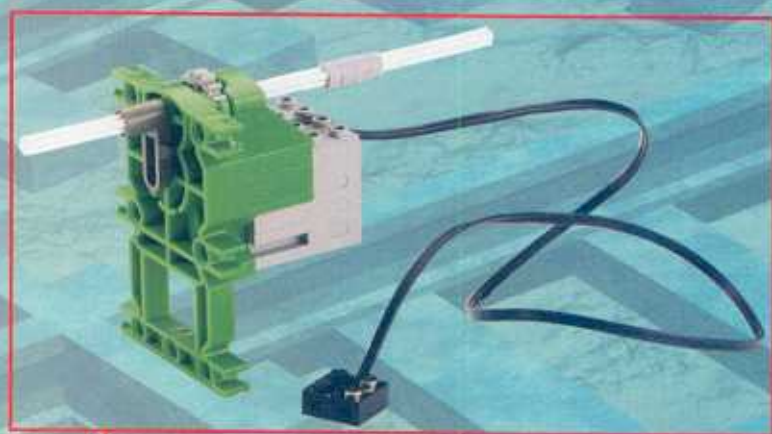

2



3



4



5



1

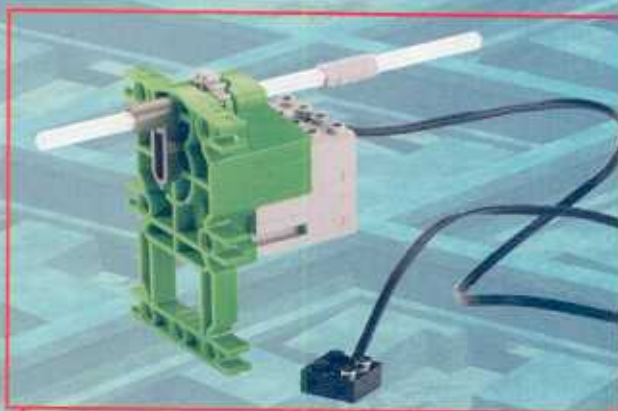

2

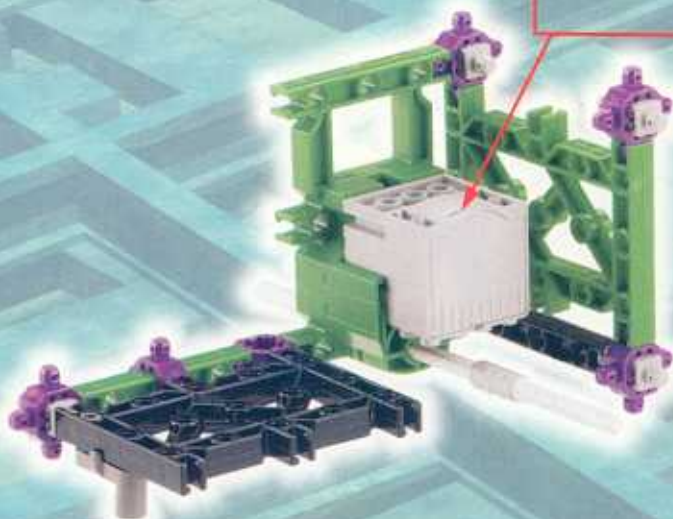

3

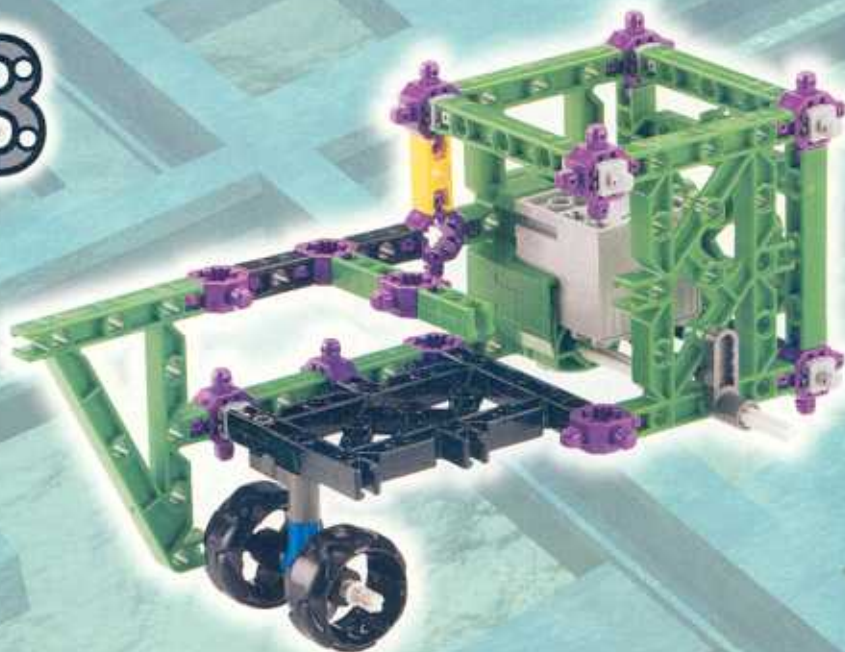

4



5



1



2



3

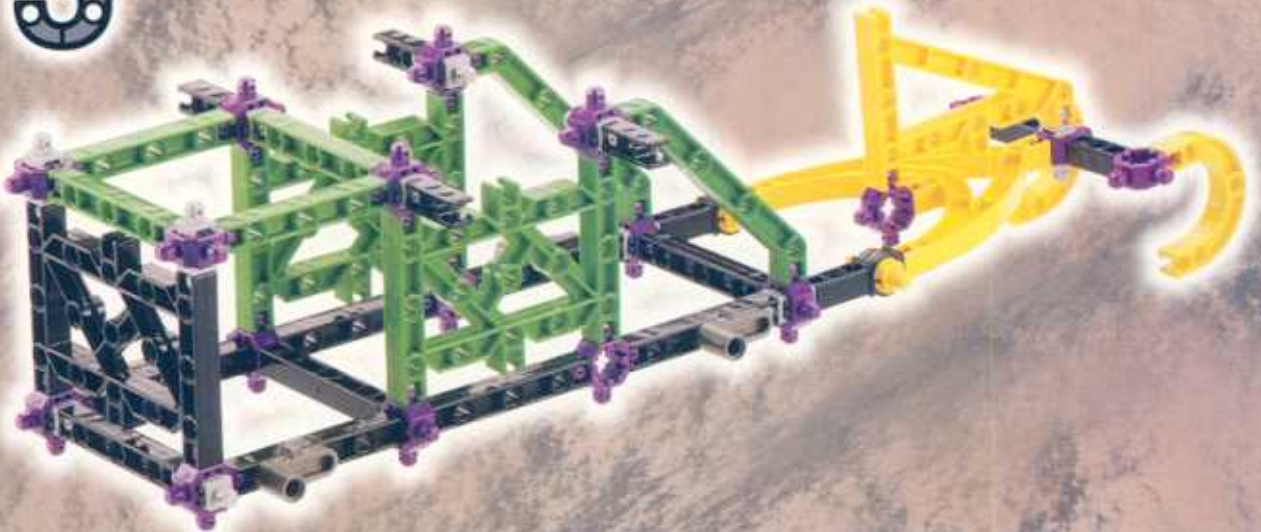

4

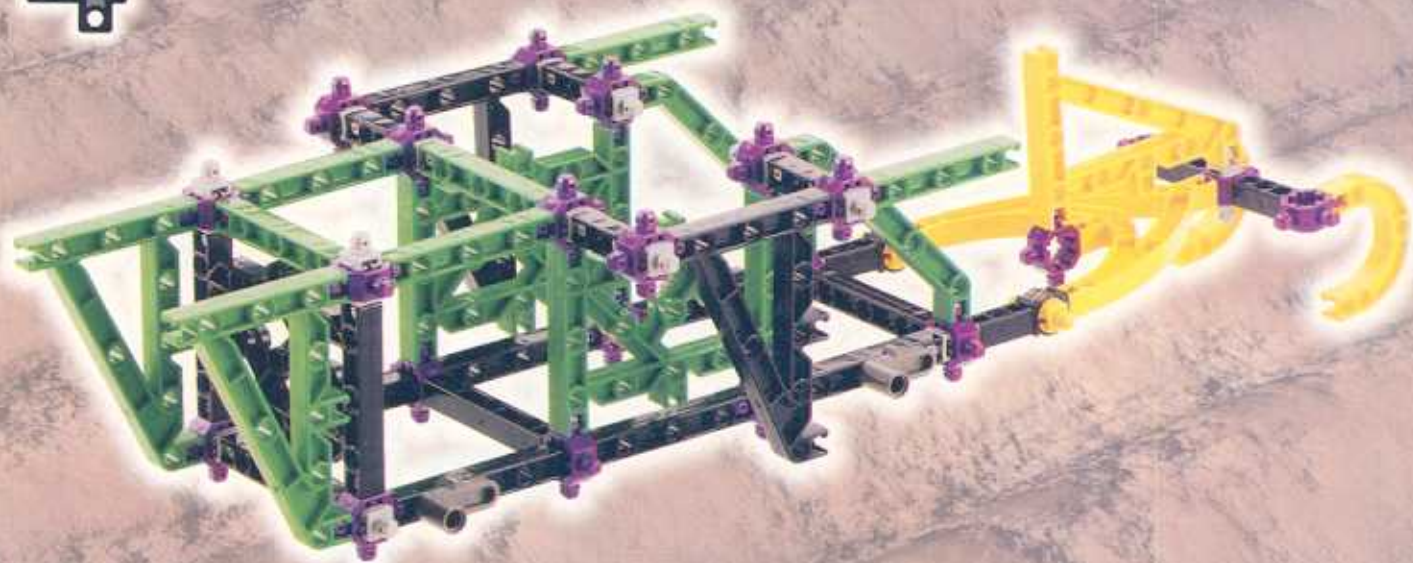

5

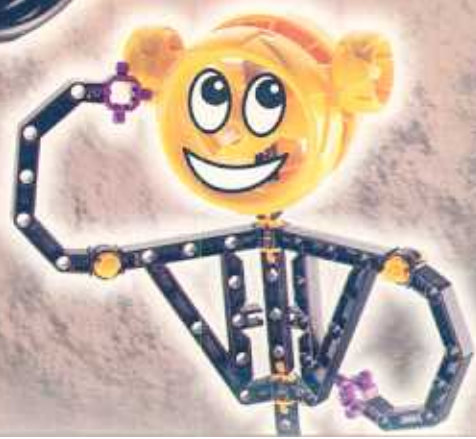
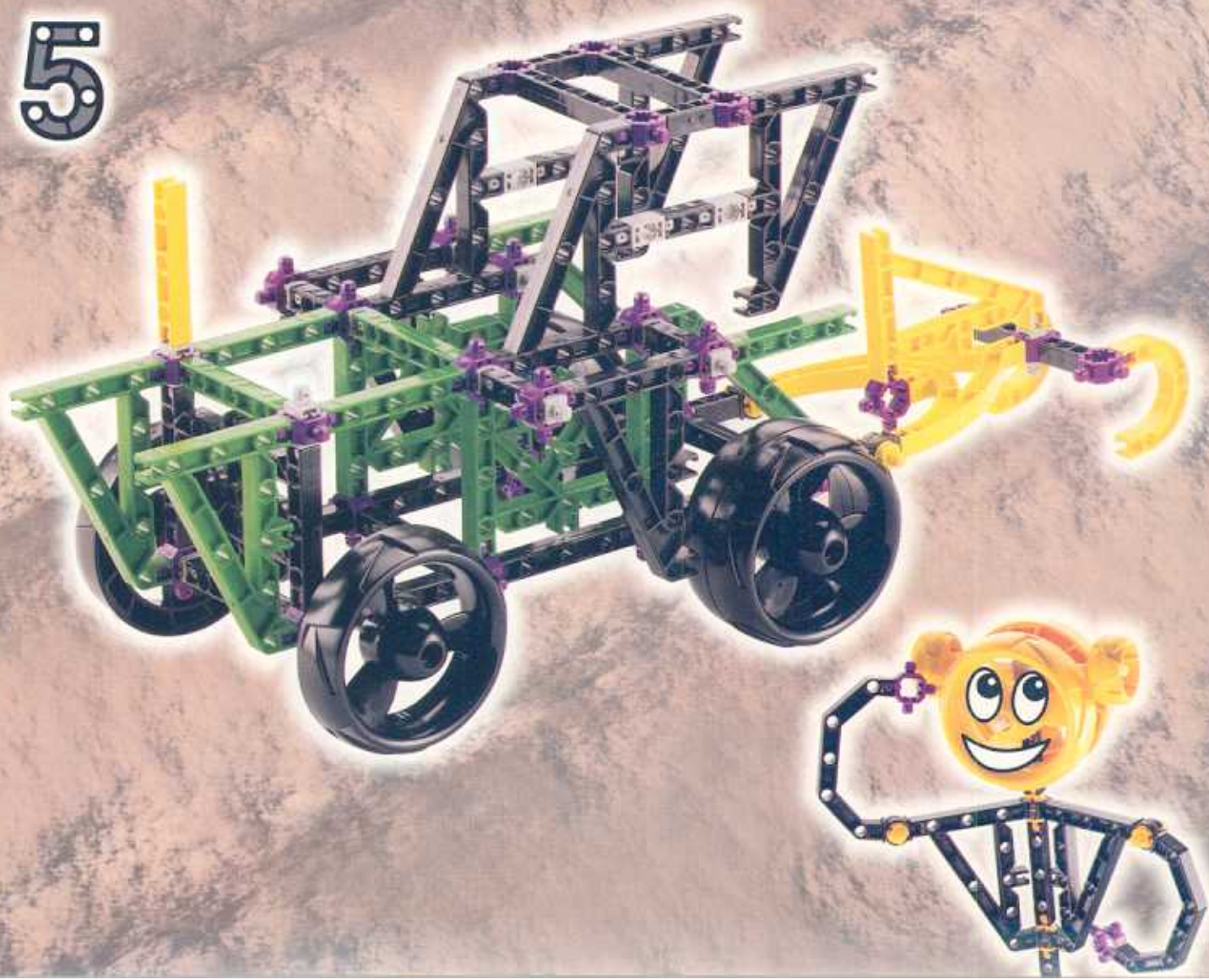

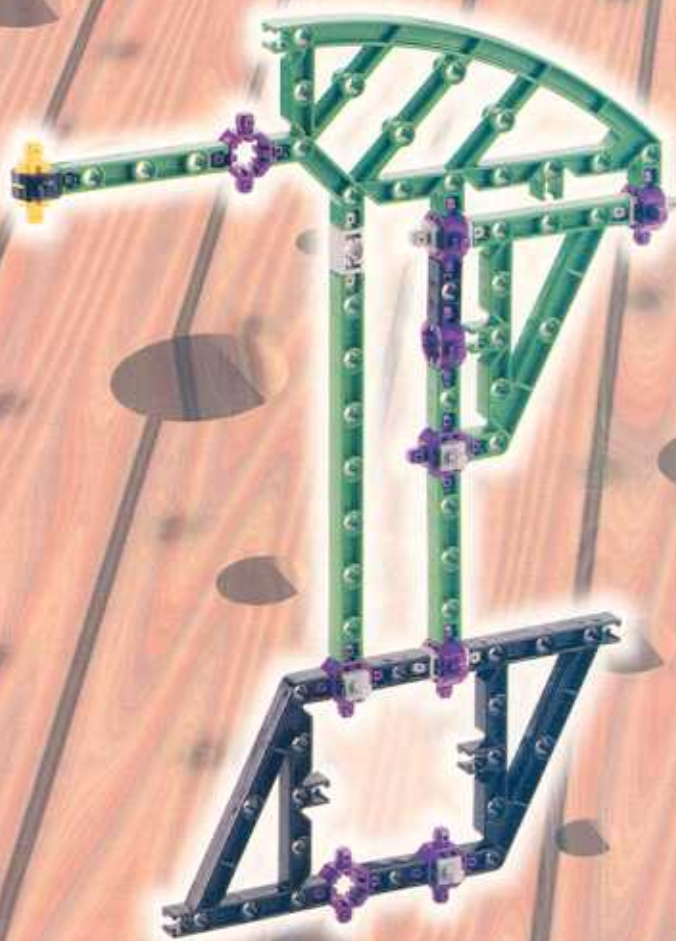
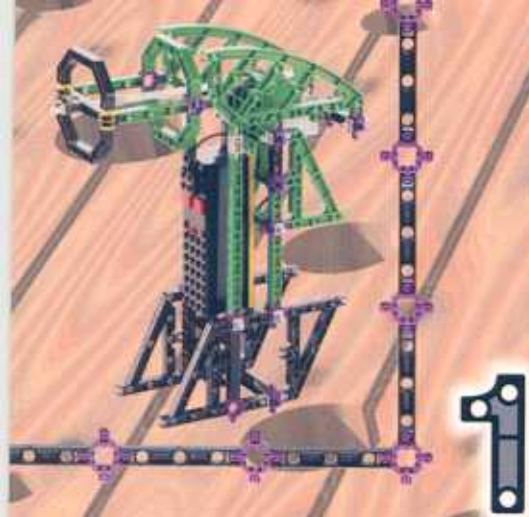

2

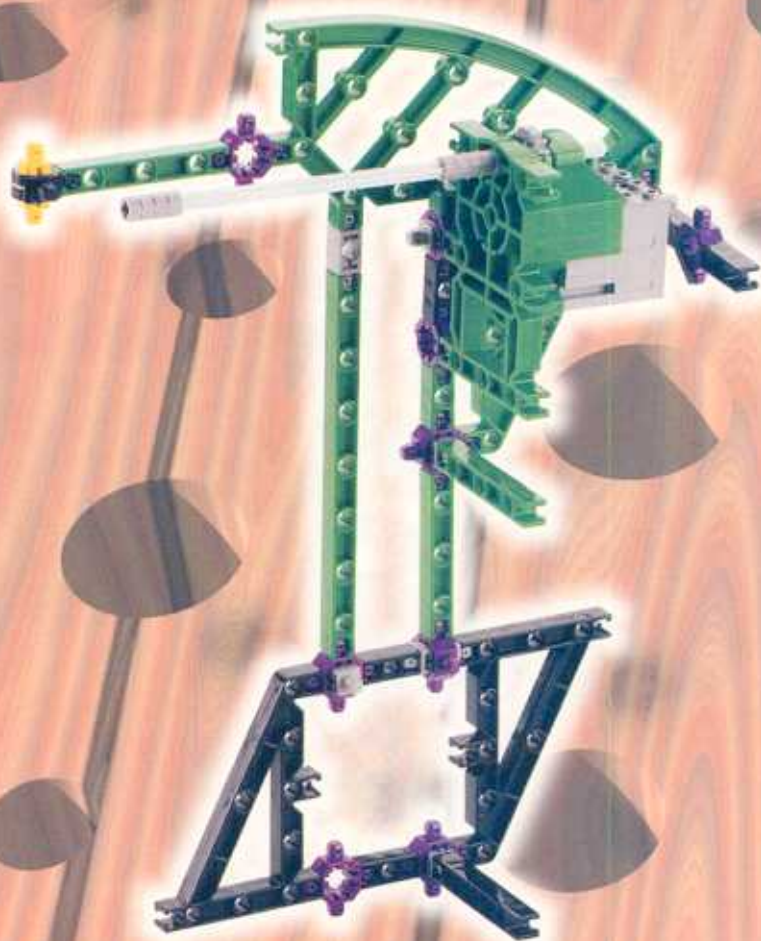

3



4

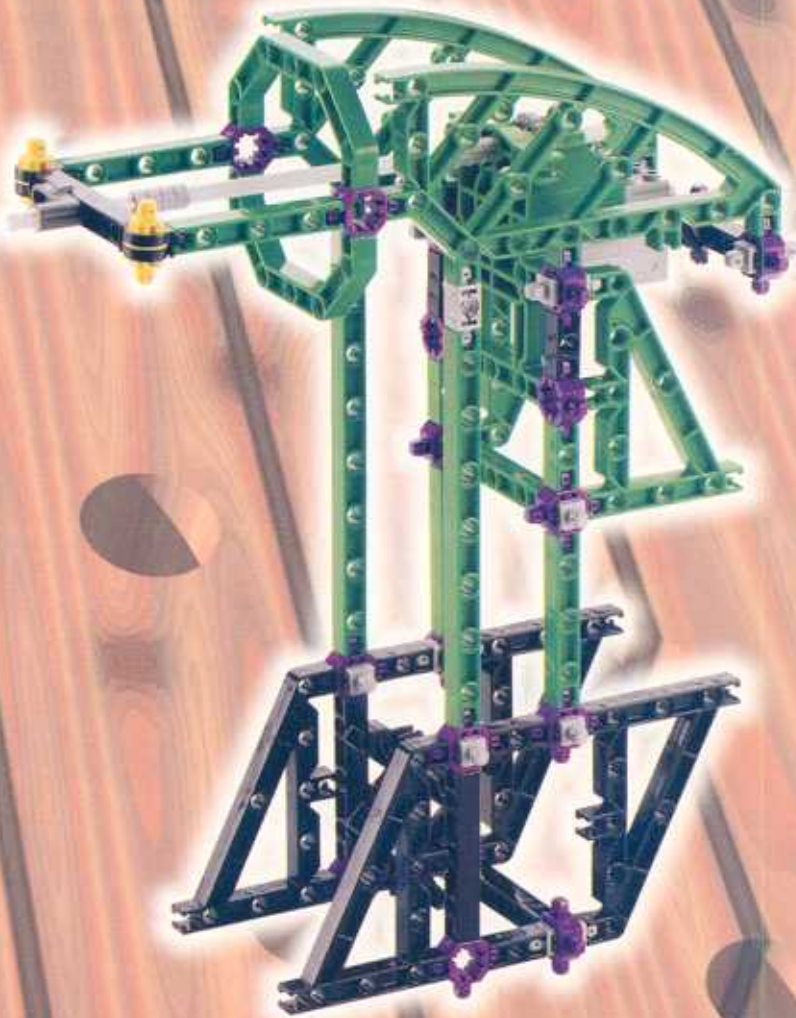

5



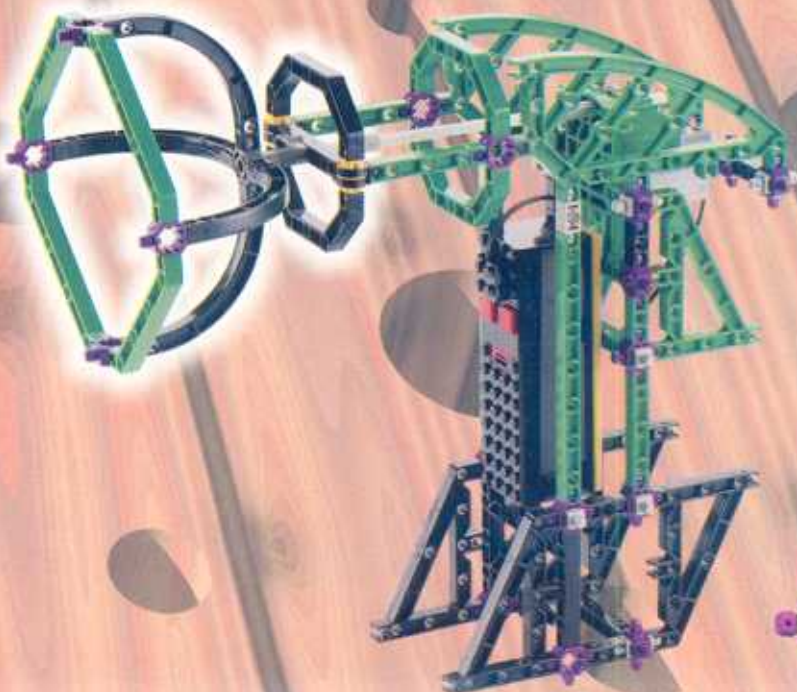







3552



3501



3502



3503



3504



3591



3581



3571



3551



3581



3532



3531



LEGO

4123879

® LEGO is a registered trademark

© 1998 LEGO Group.

<http://www.LEGO.com>

